

resistencias

resistencias para freidora

sujeción 2 orificios

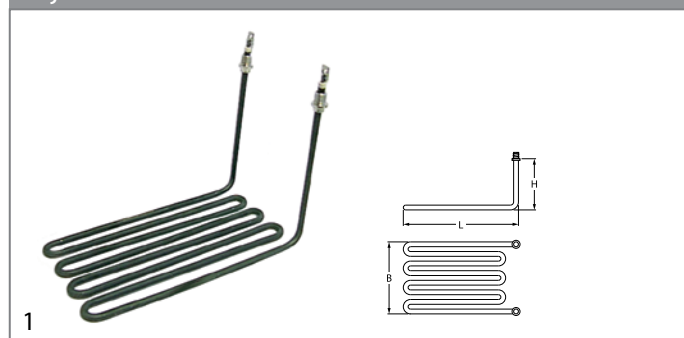

código	415920	referencia	00033120
descripción	resistencia 2800W 230V espirales 1 L 280mm An 160mm H 185mm rosca 1/4" tubo ø 8.5mm espirales 4 empalme M4 sujeción 2 orificios resistencia para freidora		
Para modelos:	EB6, EB6+6		
accesorios para	415920		
	código	510417	referencia —
	junta plana fibra ø ext. 20mm int.ø 14mm espesor 2mm UE 1 pzs		
	código	520228	referencia —
	arandela dentada int.ø 15.3mm ø ext. 24mm acero UE 1 pzs para rosca M14		
	código	520230	referencia —
	tuerca rosca M14x1,5 H 5mm EC 19 acero zincado UE 1 pzs		
	código	521101	referencia —
	tuerca rosca M14x1,5 H 5mm EC 19 inox UE 1 pzs		
	código	521103	referencia —
	tuerca rosca M4 H 3mm EC 7 latón UE 20 pzs		
	código	521104	referencia —
	arandela int.ø 4.3mm ø ext. 8mm espesor 0.5mm latón UE 20 pzs para rosca M4		
	código	550262	referencia —
	junta plana cobre ø ext. 20mm int.ø 14mm espesor 2mm		
	código	560111	referencia —
	arandela int.ø 4.3mm ø ext. 9mm espesor 0.8mm inox UE 20 pzs DIN 125A para rosca M4		
	código	560131	referencia —
	tuerca hexagonal rosca M4 H 3.2mm EC 7 inox DIN/ISO DIN 934 / ISO 4032/8673 UE 20 pzs		

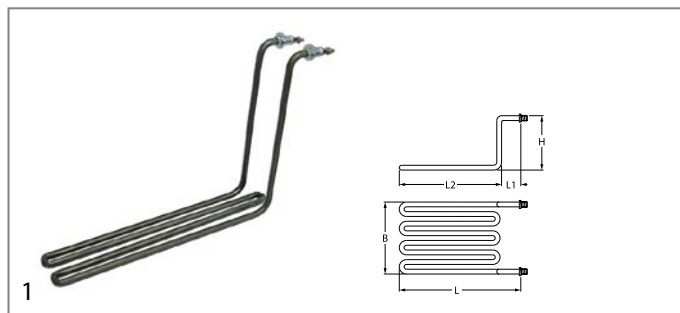

código	415921	referencia	00033130
descripción	resistencia 1260W 230V espirales 1 L 320mm An 48mm H 220mm L1 22mm L2 298mm rosca 1/4" tubo ø 8.5mm espirales 2 sujeción 2 orificios empalme M4 resistencia para freidora		
Para modelos:	EB18P, EB8		
accesorios para	415921		
	código	521103	referencia —
	tuerca rosca M4 H 3mm EC 7 latón UE 20 pzs		
	código	521104	referencia —
	arandela int.ø 4.3mm ø ext. 8mm espesor 0.5mm latón UE 20 pzs para rosca M4		
	código	560111	referencia —
	arandela int.ø 4.3mm ø ext. 9mm espesor 0.8mm inox UE 20 pzs DIN 125A para rosca M4		
	código	560131	referencia —
	tuerca hexagonal rosca M4 H 3.2mm EC 7 inox DIN/ISO DIN 934 / ISO 4032/8673 UE 20 pzs		

grupo 7



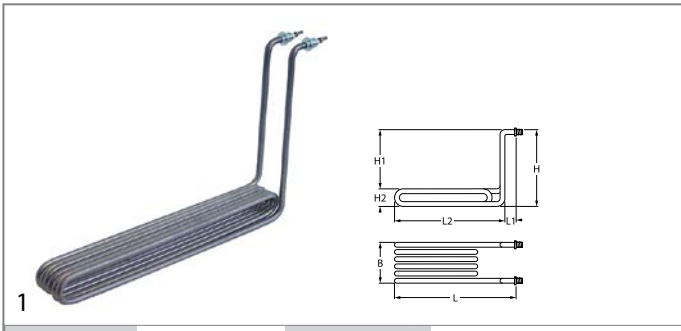

código	420210	referencia	00039276
descripción	resistencia 1600W 230V espirales 1 L 283mm An 75mm H 200mm sujeción 2 orificios empalme conector Faston 6,3mm resistencia de inmersión L1 10mm L2 273mm B1 12.5mm B2 50mm H1 20mm H2 180mm tubo ø 8.5mm rosca 1/4" distancia de sujeción 41.5mm espirales 2		
Para modelos:	ST7, ST7+7		

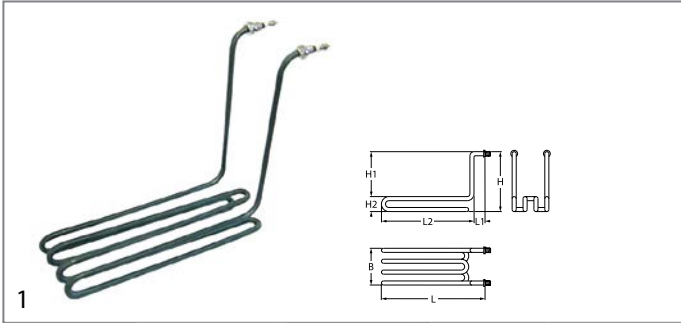

código	416783	referencia	00033154 00033155
descripción	resistencia 5500W 230V espirales 1 L 250mm An 60mm H 250mm L1 22mm L2 375mm H1 206mm H2 44mm rosca M14x1,5 tubo ø 8.5mm sujeción 2 orificios empalme M4 resistencia para freidora espirales 6		
Para modelos:	EM20, EM20+20, ES20, ESD20, FE20, FE20+20, FE30, FE30+30, KES20, KESD20		
accesorios para	416783		
	código	521103	referencia —
		tuerca rosca M4 H 3mm EC 7 latón UE 20 pzs	
	código	521104	referencia —
		arandela int.ø 4.3mm ø ext. 8mm espesor 0.5mm latón UE 20 pzs para rosca M4	
	código	560111	referencia —
		arandela int.ø 4.3mm ø ext. 9mm espesor 0.8mm inox UE 20 pzs DIN 125A para rosca M4	
	código	560131	referencia —
		tuerca hexagonal rosca M4 H 3.2mm EC 7 inox DIN/ISO DIN 934 / ISO 4032/8673 UE 20 pzs	



código	415924	referencia	00033142
descripción	resistencia 3000W 230V espirales 1 L 297mm An 86mm H 243mm L1 22mm L2 275mm H1 207mm H2 36mm rosca 1/4" distancia de sujeción 34mm tubo ø 8.5mm sujeción 2 orificios empalme M4 resistencia para freidora espirales 4		
Para modelos:	EB12, EB12+12, EB18P, EB6, EB6+6, EB8, EM12, EM12+12, ES12, ESD12, FE12		
accesorios para	415924		
	código	361182	referencia —
		tuerca rosca 1/4" H 5mm latón niquelado EC 17 UE 1 pzs	
	código	510417	referencia —
		junta plana fibra ø ext. 20mm int.ø 14mm espesor 2mm UE 1 pzs	
	código	520228	referencia —
		arandela dentada int.ø 15.3mm ø ext. 24mm acero UE 1 pzs para rosca M14	
	código	521103	referencia —
		tuerca rosca M4 H 3mm EC 7 latón UE 20 pzs	
	código	521104	referencia —
		arandela int.ø 4.3mm ø ext. 8mm espesor 0.5mm latón UE 20 pzs para rosca M4	

accesorios para	415924		
	código	550262	referencia —
		junta plana cobre ø ext. 20mm int.ø 14mm espesor 2mm	
	código	560111	referencia —
		arandela int.ø 4.3mm ø ext. 9mm espesor 0.8mm inox UE 20 pzs DIN 125A para rosca M4	
	código	560131	referencia —
		tuerca hexagonal rosca M4 H 3.2mm EC 7 inox DIN/ISO DIN 934 / ISO 4032/8673 UE 20 pzs	

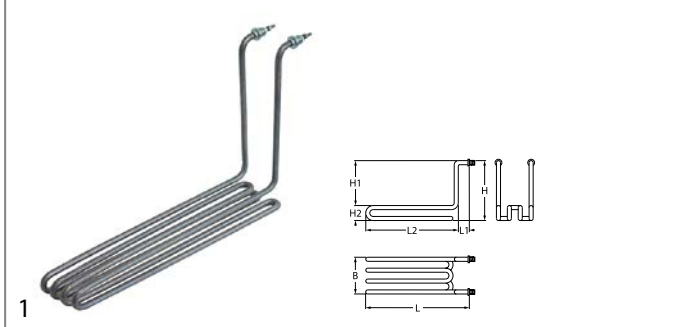

código	416782	referencia	00033150 00033151
descripción	resistencia 3333W 230V espirales 1 L 395mm An 85mm H 245mm L1 23mm L2 375mm H1 210mm H2 35mm rosca 1/4" distancia de sujeción 76mm tubo ø 8.5mm sujeción 2 orificios empalme M4 longitud de empalme 37mm resistencia para freidora espirales 4		
Para modelos:	EM20, EM20+20, EM20-900, ES20, ESD20, FE20, FE20+20, FE30, FE30+30		
accesorios para	416782		
	código	521103	referencia —
		tuerca rosca M4 H 3mm EC 7 latón UE 20 pzs	
	código	521104	referencia —
		arandela int.ø 4.3mm ø ext. 8mm espesor 0.5mm latón UE 20 pzs para rosca M4	
	código	560111	referencia —
		arandela int.ø 4.3mm ø ext. 9mm espesor 0.8mm inox UE 20 pzs DIN 125A para rosca M4	
	código	560131	referencia —
		tuerca hexagonal rosca M4 H 3.2mm EC 7 inox DIN/ISO DIN 934 / ISO 4032/8673 UE 20 pzs	

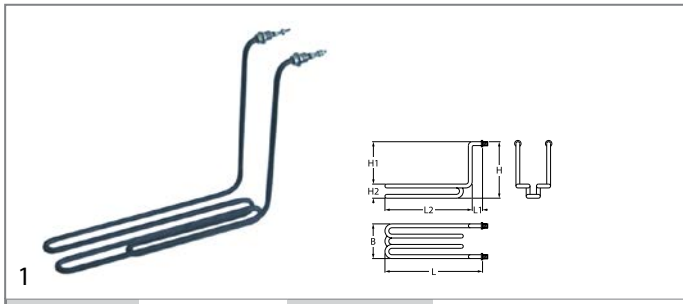

código	415922	referencia	00033140
descripción	resistencia 1680W 230V espirales 2		
Para modelos:	EB12, EB12+12, EB18P, EB6, EB6+6, EB8, EM12		

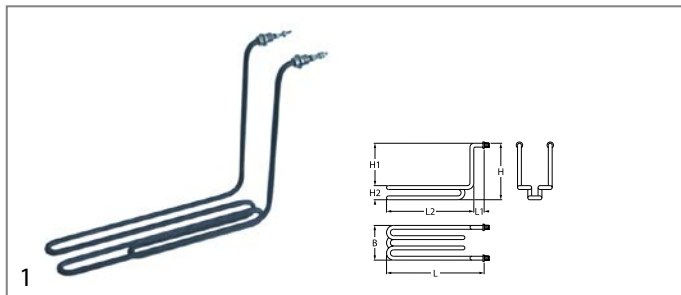

código	415923	referencia	00033141
descripción	resistencia 2000W 230V espirales 1 L 315mm An 74mm H 250mm L1 20mm L2 295mm H1 214mm H2 36mm rosca 1/4" distancia de sujeción 66mm tubo ø 8.5mm sujeción 2 orificios empalme M4 resistencia para freidora espirales 2 freidora		
Para modelos:	EB12, EB12+12, EB18P, EB6, EB6+6, EB8, EM12, EM12+12, ES12, ESD12, FE12		
repuestos para	415923		
	código	510417	referencia —
	junta plana fibra ø ext. 20mm int.ø 14mm espesor 2mm UE 1 pzs		
accesorios para	415923		
	código	361182	referencia —
	tuerca rosca 1/4" H 5mm latón niquelado EC 17 UE 1 pzs		
	código	520228	referencia —
	arandela dentada int.ø 15.3mm ø ext. 24mm acero UE 1 pzs para rosca M14		
	código	521103	referencia —
	tuerca rosca M4 H 3mm EC 7 latón UE 20 pzs		
	código	521104	referencia —
	arandela int.ø 4.3mm ø ext. 8mm espesor 0.5mm latón UE 20 pzs para rosca M4		
	código	550262	referencia —
	junta plana cobre ø ext. 20mm int.ø 14mm espesor 2mm		
	código	560111	referencia —
	arandela int.ø 4.3mm ø ext. 9mm espesor 0.8mm inox UE 20 pzs DIN 125A para rosca M4		
	código	560131	referencia —
	tuerca hexagonal rosca M4 H 3.2mm EC 7 inox DIN/ISO DIN 934 / ISO 4032/8673 UE 20 pzs		

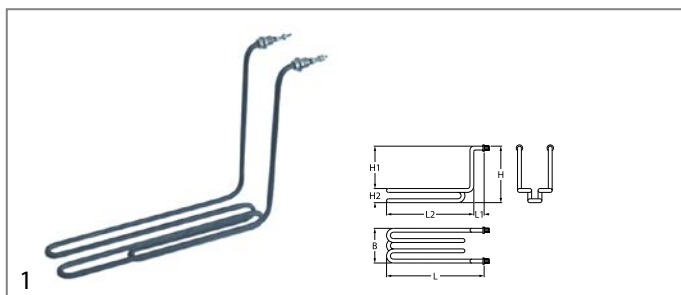

código	419056	referencia	00033145
descripción	resistencia 2000W 240V espirales 1 L 315mm An 74mm H 250mm L1 20mm L2 295mm H1 214mm H2 36mm rosca 1/4" distancia de sujeción 66mm tubo ø 8.5mm sujeción 2 orificios empalme M4 resistencia para freidora espirales 2 freidora		
Para modelos:	EB12, EB12+12, ES12, ESD12		

sujeción 6 orificios



código	420209	referencia	00039278
descripción	resistencia 9000W 230V espirales 3 L 310mm An 180mm H 235mm L1 10mm L2 300mm rosca 1/4" distancia de sujeción 34.5mm tubo ø 8.5mm sujeción 6 orificios empalme conector Faston 6,3mm resistencia de inmersión freidora		
Para modelos:	ST12, ST12+12		

resistencias de tubo de aletas



código	420345	referencia	00055600 00055640
descripción	resistencia 1400W 230V L 285mm An 135mm ø 19.5mm rosca 3/8" empalme M5 para secado espirales 1 sujeción 2 orificios		
Para modelos:	EN, ET, ET020, ETA, ETE20, ETE21, ETE25, ETE27, ETS15		

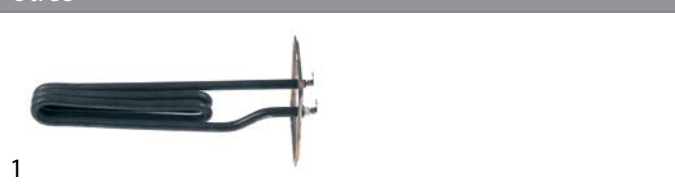

resistencias de inmersión

otros





código	418574	referencia	00203052 00203053
descripción	resistencia 3000W 230V espirales 1 L 233mm An 45mm H 29mm brida rectangular dist. del agujero 50mm agujero ø 9.5mm empalme conector Faston 6,3mm tubo ø 8.5mm longitud brida 96mm anchura brida 80mm resistencia de inmersión INCOLOY-800		
Para modelos:	BD13, BD14, BD46, BD47, BD50, BE35, BE40, BE50		
accesorios para	418574		
	código	510401	referencia 00003430
	junta goma L 88mm An 73mm espesor 5mm agujero ø 7mm dist. del agujero 65mm para resistencia 4 orificios int.ø 50mm		





			
1			
código	415178	referencia	00203049
descripción	resistencia 3000W 230V resistencia de inmersión		
Para modelos:	42, 42E, 48, 48E, 55, 55E, 60, 882, B11, B15, BD11, BD13, BD14, BD14alt, BD22, BE35, BE40, BE50, D30		



			
1			
código	418548	referencia	00003305 00003324 00003325
descripción	resistencia 5200W 230V espirales 3 L 325mm An 47mm H 50mm tubo ø 8.5mm dist. del agujero 62mm agujero ø 9.3mm empalme M4 brida 4 orificios resistencia de inmersión anchura brida 81mm longitud brida 96mm con fusible térmico		
Para modelos:	120, 160, 240, 885, 904, 906, 908, 912, C33, C34, C34dgt, C44, C44dgt, C44dgt-elt, C66, C66dgt, C66dgt-elt, C77, CE24, D120, D120dgt, D30, D35, D36, D40, D40ELT, D40ELT-BT-BA, D40i, D40i-BT-BA, D40i-ELT-BT-BA, D45, D80, D80F, D85, LP60		
repuestos para	418548		
	código	510401	referencia 00003430
	junta goma L 88mm An 73mm espesor 5mm agujero ø 7mm dist. del agujero 65mm para resistencia 4 orificios int.ø 50mm		

			
1			
código	415031	referencia	00003324
descripción	resistencia 5700W 230V espirales 3		
accesorios para	415031		
	código	510401	referencia 00003430
	junta goma L 88mm An 73mm espesor 5mm agujero ø 7mm dist. del agujero 65mm para resistencia 4 orificios int.ø 50mm		



			
1			
código	415032	referencia	00003330 00003334
descripción	resistencia 7500W 230V espirales 3 brida 4 orificios resistencia de inmersión		
Para modelos:	120, 160, 240, 882, 885, 904, 906, 908, 912, C33, C34, C34dgt, C44, C66, C66dgt, C66dgt-elt, C77, D120, D120dgt, D30, D36, D40, D40ELT, D40ELT-BT-BA, D40i, D40i-ELT-BT-BA, D45, D80, D80F, D85, EN, ET, ETE20, ETA, ETE20, ETE21, ETE25, ETE27, ETS15, LP130, LP60, LP60H, LP61, LP61H, LP70, LPE100, LPE145, SQ885, SQT80		
accesorios para	415032		
	código	510401	referencia 00003430
	junta goma L 88mm An 73mm espesor 5mm agujero ø 7mm dist. del agujero 65mm para resistencia 4 orificios int.ø 50mm		
	código	521103	referencia —
	tuerca rosca M4 H 3mm EC 7 latón UE 20 pzs		
	código	521104	referencia —
	arandela int.ø 4.3mm ø ext. 8mm espesor 0.5mm latón UE 20 pzs para rosca M4		





accesorios para	415032		
	código	560111	referencia —
	arandela int.ø 4.3mm ø ext. 9mm espesor 0.8mm inox UE 20 pzs DIN 125A para rosca M4		
	código	560131	referencia —
	tuerca hexagonal rosca M4 H 3.2mm EC 7 inox DIN/ISO DIN 934 / ISO 4032/8673 UE 20 pzs		

			
1			
código	415033	referencia	00003349 old version
descripción	resistencia 9000W 230V espirales 3 L 322mm An 37mm H 68mm tubo ø 6.3mm dist. del agujero 67/45mm agujero ø 10mm empalme M4 brida 4 orificios resistencia de inmersión		
accesorios para	415033		
	código	510401	referencia 00003430
	junta goma L 88mm An 73mm espesor 5mm agujero ø 7mm dist. del agujero 65mm para resistencia 4 orificios int.ø 50mm		
	código	521103	referencia —
	tuerca rosca M4 H 3mm EC 7 latón UE 20 pzs		
	código	521104	referencia —
	arandela int.ø 4.3mm ø ext. 8mm espesor 0.5mm latón UE 20 pzs para rosca M4		
	código	560111	referencia —
	arandela int.ø 4.3mm ø ext. 9mm espesor 0.8mm inox UE 20 pzs DIN 125A para rosca M4		
	código	560131	referencia —
	tuerca hexagonal rosca M4 H 3.2mm EC 7 inox DIN/ISO DIN 934 / ISO 4032/8673 UE 20 pzs		

			
1			
código	420213	referencia	00003335
descripción	resistencia 9000W 240V espirales 3 L 483mm An 46mm H 40mm tubo ø 8.5mm dist. del agujero 65mm agujero ø 9.5mm empalme M4 brida 4 orificios resistencia de inmersión anchura brida 81mm longitud brida 96mm		
Para modelos:	CE24, ETE20, ETE21, ETE25, ETE27, ETS15, LP130		
accesorios para	420213		
	código	510401	referencia 00003430
	junta goma L 88mm An 73mm espesor 5mm agujero ø 7mm dist. del agujero 65mm para resistencia 4 orificios int.ø 50mm		







			
código	418879	referencia	00003349
descripción	resistencia 9800W 230V espirales 3 L 322mm An 37mm H 68mm casquillo portasondas 2 ø casquillo portasondas 6,5/10mm longitud casquillo portasondas 185/80mm tubo ø 6.3mm dist. del agujero 65/45mm agujero ø 10mm empalme M4 brida 4 orificios resistencia de inmersión anchura brida 81mm longitud brida 96mm		
Para modelos:	120, 160, 240, 885, 904, 906, 908, 912, C33, C34, C34dgt, C44, C44dgt, C44dgt-elt, C66, C66dgt, C66dgt-elt, C77, CW650-15, CW650-16, CW650-35, CW650-36, D120, D120dgt, D30, D40, D40ELT, D40ELT-BT-BA, D40i, D40i-BT-BA, D40i-ELT-BT-BA, D45, D80, D80F, D85, EN, ET, ET020, ETA, ETE20, ETE21, ETE25, ETE27, ETS15, LP130, LP60, LP60H, LP61, LP61H, LP70		
accesorios para	418879		
		código	510401 referencia 00003430
	junta goma L 88mm An 73mm espesor 5mm agujero ø 7mm dist. del agujero 65mm para resistencia 4 orificios int.ø 50mm		

			
código	415153	referencia	00002430 00003251 00003270 00003271
descripción	resistencia 5700W 230V espirales 3 rosca 1 1/4" L 300mm An 85mm H 42mm L1 120mm L2 180mm B1 29mm B2 28mm H1 21mm H2 21mm tubo ø 6.3mm empalme conector Faston 6,3mm longitud de empalme 40mm brida roscada resistencia de inmersión		
Para modelos:	120, 160, 240, 882, 885, 904, 906, 908, 912, C33, C44, C44dgt, C44dgt-elt, C66, C66dgt, C66dgt-elt, C77, D120, D120dgt, D35, D36, D40, D40ELT, D40ELT-BT-BA, D40i, D40i-ELT-BT-BA, D45, D80, D80F, D85, LP60, LP60H, LP61, LP61H, LP70		
repuestos para	415153		
		código	510405 referencia —
	junta plana fibra ø ext. 56mm int.ø 42mm espesor 2mm para rosca 1 1/4" UE 1 pzs		
accesorios para	415153		
		código	520232 referencia —
	tuerca rosca 1 1/4" H 5mm latón níquelado EC 47 UE 1 pzs		
		código	528021 referencia —
	junta plana PTFE ø ext. 53mm int.ø 42.5mm espesor 3mm UE 1 pzs núm. Ref. 12001/02286 para Astoria/Aurora/Brasilia/Wega		

			
código	418981	referencia	00003277
descripción	resistencia 1000/1300/1400W 200/230/240V espirales 1 L 213mm An 67mm H 29mm rosca 1/4" distancia de sujeción 61mm tubo ø 6.3mm empalme conector Faston 6,3mm resistencia de inmersión		
Para modelos:	BD46, BD47, BE35, BE40		

			
código	416281	referencia	00203091
descripción	resistencia 2000W 230V espirales 1 L 300mm An 76mm H 30mm rosca 1/4" distancia de sujeción 80mm tubo ø 6.3mm empalme conector Faston 6,3mm sujeción 2 orificios longitud de empalme 15mm resistencia de inmersión		
Para modelos:	B11, B15, BD11, BD13, BD14, BD14alt, BD22, BD46, BD47, D30, D35, D36, D40, D40ELT, D40ELT-BT-BA, D40i, D40i-ELT-BT-BA		
repuestos para	416281		
		código	510417 referencia —
	junta plana fibra ø ext. 20mm int.ø 14mm espesor 2mm UE 1 pzs		
accesorios para	416281		
		código	361182 referencia —
	tuerca rosca 1/4" H 5mm latón níquelado EC 17 UE 1 pzs		
		código	520228 referencia —
	arandela dentada int.ø 15.3mm ø ext. 24mm acero UE 1 pzs para rosca M14		
		código	550262 referencia —
	junta plana cobre ø ext. 20mm int.ø 14mm espesor 2mm		

			
código	415176	referencia	00203089
descripción	resistencia 2700W 230V espirales 1 L 350mm An 70mm rosca 1/4" distancia de sujeción 64mm tubo ø 6.25mm sujeción 2 orificios resistencia de inmersión empalme conector Faston 6,3mm		
Para modelos:	42, 42E, 48, 48E, 55, 55E, 60		

			
código	416282	referencia	00018070
descripción	resistencia 3200W 230V espirales 1 L 350mm An 77mm H 33mm rosca 1/4" distancia de sujeción 71mm tubo ø 6.3mm empalme conector Faston 6,3mm sujeción 2 orificios resistencia de inmersión		
Para modelos:	882, 885, BD50, BE50, BE50T, C33, C34, C34dgt, C44, C44dgt, C44dgt-elt, C66, C77, CE24, D120, D120dgt, D80, D80F, D85, LP60, LP60H		
repuestos para	416282		
		código	510417 referencia —
	junta plana fibra ø ext. 20mm int.ø 14mm espesor 2mm UE 1 pzs		
accesorios para	416282		
		código	361182 referencia —
	tuerca rosca 1/4" H 5mm latón níquelado EC 17 UE 1 pzs		
		código	520228 referencia —
	arandela dentada int.ø 15.3mm ø ext. 24mm acero UE 1 pzs para rosca M14		
		código	550262 referencia —
	junta plana cobre ø ext. 20mm int.ø 14mm espesor 2mm		



termostatos

termostatos de superficie

termostatos de superficie de seguridad



1

código	390748	referencia	22110020
descripción	termómetro de superficie de seguridad dist. del agujero 23.5mm temp. desconexión 100°C 1NC 1 polosA empalme F6,3		
Para modelos:	42, 42E, 48, 48E, 55, 55E, 60, 882, B11, B15, BD11, BD13, BD14, BD14alt, BD22, BE35, BE40, D30		



1

código	390681	referencia	22110021
descripción	termómetro de superficie de seguridad dist. del agujero 40mm temp. desconexión 105°C 2NC 2 polos 16A 250V empalme F6,3		
Para modelos:	BE35, BE40, BE50		



1

código	375757	referencia	22110020 old version
descripción	termómetro de superficie de seguridad temp. desconexión 100°C 1NC 1 polos 16A empalme F6,3		

termostatos de superficie



1

código	390909	referencia	22180101
descripción	termostato de contacto dist. del agujero 46mm temp. desconexión 56°C 1NC 1 polos 16A 250V empalme F6,3 UE 1 pzs		
Para modelos:	BE35, BE40		

termostatos de control y seguridad

EGO

termostatos de regulación

serie 55.10/19_



1

código	390779	referencia	22140003 22140004
descripción	termóstato T máx 190°C margen de trabajo 105-190°C 1 polos 1NO 0.5A sonda ø 4mm sonda L 235mm capilar 1470mm aislamiento del capilar 1250mm prensaestopas M10x1 eje ø 6x4,6mm eje L 23mm posición del eje abajo ángulo de rotación 270°		
Para modelos:	ES12, ES20, ESD12, ESD20, GSDT12, GSDT20, GST12, GST20, GW209T, GWD209T, GWDT12, GWDT20, GWT12, GWT20, ST12, ST12+12, ST7, ST7+7		



1

código	390731	referencia	22140002
descripción	termóstato T máx 195°C margen de trabajo 65-195°C 1 polos 1NO 16A sonda ø 4mm sonda L 106mm capilar 1470mm aislamiento del capilar 1250mm prensaestopas eje ø 6x4,6mm eje L 23mm posición del eje arriba ángulo de rotación 270°		
Para modelos:	GSDT12, GSDT20, GST12, GST20, GVM35T, GWDT12, GWDT20, GWT12, GWT20, ST12, ST12+12, ST4, ST6, ST7, ST7+7		





código	390174	referencia	00003323 22140001
descripción	termóstato T máx 204°C margen de trabajo 65-204°C 1 polos 1NO 16A sonda ø 4mm sonda L 89mm capilar 600mm aislamiento del capilarmm prensaestopas eje ø 6x4,6mm eje L 23mm posición del eje arriba ángulo de rotación 270° material de bulbo inox		
Para modelos:	EB12, EB12+12, EB18P, EB6, EB6+6, EB8, EM12, EM12+12, EM20, EM20+20, EM20+20-900, EM20-900, EM240, EM35, EM360, EM40-900, EM480, EM612, ES12, ES20, ESD12, ESD20, FE12, FE20, FE20+20, FE30, FE30+30, KES20, KESD20		

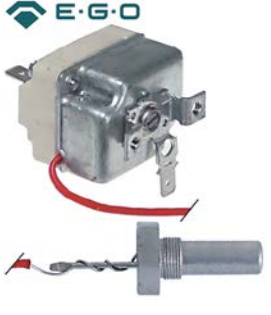

código	375534	referencia	22180004
descripción	termóstato T máx 90°C margen de trabajo 19-90°C 1 polos 1CO 16A sonda ø 6mm sonda L 129mm capilar 980mm aislamiento del capilar 960mm prensaestopas eje Lmm posición del eje ángulo de rotación 180°		
Para modelos:	B11, B15, BD11, BD13, BD14, BD14alt, BD22, BD46, BD47, BD50, BE35, BE40, BE50, BE50T, C33, C34, C34dgt, C44, C44dgt, C44dgt-elt, C66, C66dgt, C66dgt-elt, C77, CE24, CW650-15, CW650-16, CW650-35, CW650-36, D120, D120dgt, D30, D35, D36, D40, D40i, D40i-BT-BA, D45, D80, D80F, D85, ETE20, ETE21, ETE25, ETE27, LP60, LP60H, LP61, LP61H, LP70		



código	390172	referencia	0000317a 00057151 22110002
descripción	termóstato T máx 50°C margen de trabajo ajuste fijo 50°C 1 polos 1CO 16A sonda ø 11mm sonda L 45mm capilar 850mm aislamiento del capilar 830mm prensaestopas eje Lmm posición del eje sonda roscada sonda 3/8"		
Para modelos:	120, 160, 240, 42, 42E, 48, 48E, 55, 55E, 60, 882, 885, 904, 906, 908, 912, B11, B15, BD11, BD13, BD14, BD14alt, BD22, BD46, BD47, BD50, BE50, BE50T, C33, C34, C34dgt, C44, C44dgt, C44dgt-elt, C66, C66dgt, C66dgt-elt, C77, CW650-15, CW650-16, CW650-35, CW650-36, D120, D120dgt, D30, D35, D36, D40, D40i, D45...(Otros modelos se puede ver en la tienda web)		
accesorios para	390172		
	código	506024	referencia —
	tuerca rosca 3/8" H 6mm inox EC 22 UE 1 pzs		
	código	521137	referencia —
	junta plana fibra ø ext. 20mm int.ø 18mm espesor 1.5mm para rosca 3/8" UE 1 pzs		

serie 55.34_



código	390057	referencia	00033240 22160001
descripción	termóstato T máx 192°C margen de trabajo 100-192°C 3 polos 3NO 16A sonda ø 7mm sonda L 200mm capilar 870mm aislamiento del capilarmm prensaestopas eje ø 6x4,6mm eje L 23mm posición del eje arriba° ángulo de rotación 270°		
Para modelos:	EB12, EB12+12, EB18P, EB6, EB6+6, EB8, EM12, EM12+12, EM20, EM20+20, EM20+20-900, EM20-900, EM35, EM40-900, ES12, ESD12		



código	390043	referencia	00003190
descripción	termóstato T máx 80°C margen de trabajo ajuste fijo 80°C aislamiento del capilarmm prensaestopas		

E-G-O

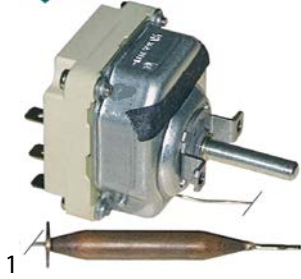

código	390042	referencia	00003190 0000319A 22190001
descripción	termostato T máx 85°C margen de trabajo 35-85°C 3 polos 3CO 16A sonda ø 9.5mm sonda L 80mm capilar 870mm aislamiento del capilar mm prensaestopas eje ø 6x4,6mm eje L 23mm posición del eje arriba° ángulo de rotación 180° con disco ø arandela 10mm		

termostatos de seguridad

serie 55.10/19_

E-G-O



código	390738	referencia	22180100
descripción	termostato de seguridad temp. desconexión 107°C 1 polos 1NC 16A sonda ø 6mm sonda L 77mm capilar 1170mm aislamiento del capilar 1150mm prensaestopas bulbo material de bulbo inox		
Para modelos:	EN, ET, ET020, ETA, LPE100, LPE145		

E-G-O

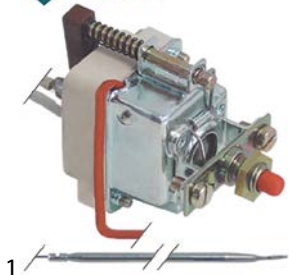

código	375178	referencia	22170001
descripción	termostato de seguridad temp. desconexión 230°C 1 polos 0.5A sonda ø 4mm sonda L 116mm capilar 1500mm aislamiento del capilar mm prensaestopas bulbo inox		
Para modelos:	FG125, FG12M, FG157, FG159, FG24M, FG307, FG309, GB10, GBD10, GM12, GM12+12, GM20+20, GM20+20-900, GM25+25-900, GM2532, GM2542, GM25-900, GM35, GM50-900, GMD2532, GMD2542, GSDT12, GSDT20, GST12, GST20, GVM35, GVM35T, GW12, GW20, GWD12, GWD20, GWD12, GWD12, GWD20, GW-MODULARI, GWT12, GWT20		

E-G-O



código	390730	referencia	161142 22170003
descripción	termostato de seguridad temp. desconexión 230°C 1 polos 0.5A sonda ø 4mm sonda L 125mm capilar 1550mm aislamiento del capilar 1410mm prensaestopas bulbo		
Para modelos:	FG12M, FG24M, GB10, GBD10, GSDT12, GSDT20, GST12, GST20, GVM35T, GW12ELT, GW209T, GW20ELT, GWD12ELT, GWD209T, GWD20ELT, GWD12, GWD20, GWT12, GWT20		

serie 55.14_

E-G-O



código	390176	referencia	00003227 22130001
descripción	termostato de seguridad temp. desconexión 230°C 1 polos 16A sonda ø 6mm sonda L 74mm capilar 600mm aislamiento del capilar mm prensaestopas bulbo inox		
Para modelos:	EB12, EB12+12, EB18P, EB6, EB6+6, EB8, EM12, EM12+12, EM20, EM20+20, EM20+20-900, EM20-900, EM35, EM40-900		

serie 55.31_

E-G-O



código	390091	referencia	22150001
descripción	termostato de seguridad temp. desconexión 230°C 3 polos 20A sonda ø 6mm sonda L 239mm capilar 830mm aislamiento del capilar mm prensaestopas bulbo inox 380V		
Para modelos:	EB12, EB12+12, EB18P, EB6, EB6+6, EB8, EM12, EM12+12, EM20, EM20+20, EM20+20-900, EM20-900, EM35, EM40-900, FE12, FE20, FE20+20, FE30, FE30+30		

serie 55.32_

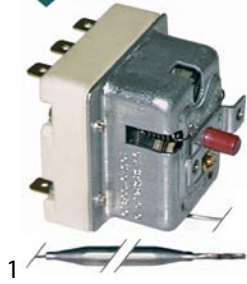



código	390178	referencia	22100002
descripción	termostato de seguridad temp. desconexión 124°C 3 polos 20A sonda ø 6mm sonda L 74mm capilar 900mm aislamiento del capilar 900mm prensaestopas bulbo inox		
Para modelos:	120, 160, 240, 882, 885, 904, 906, 908, 912, C33, C34, C34dgt, C44, C44dgt, C44dgt-elt, C66, C66dgt, C66dgt-elt, C77, CE24, D120, D120dgt, D30, D35, D36, D40, D40ELT, D40ELT-BT-BA, D40i, D40i-BT-BA, D45, D80, D80F, D85, EN, ET, ET020, ETA, ETE20, ETE21, ETE25, ETE27, ETS15, LP130, LP60, LP60H, LP61, LP61H, LP70, SQ885...(Otros modelos se puede ver en la tienda web)		

IMIT / TEMPOMATIC / ARTHERMO

termostatos de regulación



código	390173	referencia	00003170 00057150
descripción	termostato T máx 87°C margen de trabajo 27-87°C 1 polos 1CO 15A sonda ø 6.5mm sonda L 95mm capilar 1000mm aislamiento del capilar 1000mm prensaestopas eje ø 6x4,6mm eje L 19mm ángulo de rotación 270° con disco ø arandela 14.5mm		
Para modelos:	120, 160, 240, 42, 42E, 48, 48E, 55, 55E, 60, 882, 885, 904, 906, 908, 912, C33, C44, C66, D120, EN, ET, ET020, ETA, LP130, LP60, LP70, LPE100, LPE145, SQ885, SQT80		
accesorios para	390173		
		código	110100 referencia —
			pomo termostato T máx 90°C 0-90°C ø 42mm eje ø 6x4,6mm parte plana -135° negro
		código	110310 referencia —
			roseta pomo hasta ø 45mm

serie 55.33_



código	375796	referencia	00032280 22150002 22150003
descripción	termostato de seguridad temp. desconexión 220°C 3 polos 3NC 20A sonda ø 6mm sonda L 107mm capilar 870mm aislamiento del capilar 800mm prensaestopas bulbo		
Para modelos:	EB12, EB12+12, EB8, EM12, EM12+12, EM20, EM20+20, ES12, ES20, ESD12, ESD20, KES20, KESD20, ST12, ST12+12, ST7, ST7+7		

termostatos de seguridad



código	375850	referencia	22130002
descripción	termostato de seguridad temp. desconexión 230°C 1 polos 1NC 15A sonda ø 3.5mm sonda L 200mm capilar 950mm aislamiento del capilar 950mm prensaestopas bulbo inox 250V		
Para modelos:	EM20, EM20+20, ES20, ESD20, KES20, KESD20, ST12, ST12+12		

serie 56_



código	390714	referencia	00032270
descripción	termostato de seguridad temp. desconexión 230°C 1 polos 1NC 16A sonda ø 6mm sonda L 75mm capilar 740mm aislamiento del capilar 200mm prensaestopas bulbo inox		
Para modelos:	EB6, EB6+6, ES20, ESD20, KES20, KESD20, ST4, ST6		

diversos

termostatos de regulación

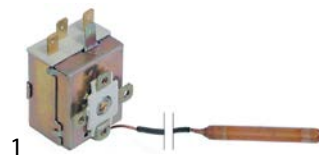

código	390196	referencia	22180004 old version
descripción	termostato T máx 93°C margen de trabajo 35-93°C 1 polos		



accesorios

piezas de sujeción

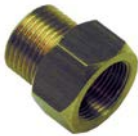
			
1			
código	511627	referencia	00003400
descripción	unión roscada para calentador de agua H M16x1 M 3/8"		
Para modelos:	120, 160, 240, 42, 42E, 48, 48E, 55, 55E, 60, 882, 885, 904, 906, 908, 912, D30, LPE100, LPE145, SQ885, SQT80		

conducciones para prensaestopas

			
1			
código	551076	referencia	00038680
descripción	conducción para prensaestopas M M11x1 H M10x1 sonda ø máx. 4mm EC 22 cobre acero inoxidable L 30mm		
Para modelos:	FG12M, FG24M, GB10, GBD10, GSDT12, GSDT20, GST12, GST20, GW209T, GWDT12, GWDT20, GWT12, GWT20		

casquillos de inmersión

			
1			
código	550139	referencia	00030500
descripción	casquillo de inmersión rosca 3/4" L 310mm inox doble ø 8mm agujero ø 7mm		
Para modelos:	FG125, FG157, FG159, FG307, FG309, GM12, GM12+12, GM20+20, GM20+20-900, GM25+25-900, GM2532, GM2542, GM25-900, GM35, GM50-900, GMD2532, GMD2542, GVM35, GVM35T, GW12, GW20, GWD12, GWD20, GW-MODULARI		
accesorios para	550139		
	código	520234	referencia —
	tuerca rosca 3/4" H 5mm latón EC 30 UE 1 pzs		

otros

			
1			
código	550268	referencia	00032290
descripción	tapa para tecla		
Para modelos:	EB12, EB12+12, EB18P, EB6, EB6+6, EB8, EM12, EM12+12, EM20, EM20+20, EM20+20-900, EM20-900, EM35, EM40-900, ES12, ES20, ESD12, ESD20, FE12, FE20, FE20+20, FE30, FE30+30, KES20, KESD20		

interruptores y pulsadores

interruptores pulsantes y pulsadores

17x13mm			
			
1			
código	345950	referencia	28160041
descripción	pulsador medida de montaje 17x13mm gris 2CO 250V 16A empalme conector Faston 6,3mm temperatura ambiente máx. 150/75°C protección IP40		
Para modelos:	BD14, C33		

20,6x16,4mm			
			
1			
código	345949	referencia	28160040
descripción	interruptor pulsante montaje ø 20,6x16,4mm gris 2CO 250V 16A empalme conector Faston 6,3mm temperatura ambiente máx. 150°C protección IP40		
Para modelos:	BD14, C33		

			
1			
código	345948	referencia	28160038 28160039
descripción	pulsador medida de montaje 20,6x16,4mm gris 2CO 250V 16A salida empalme conector Faston 6,3mm temperatura ambiente máx. 150°C protección IP40		
Para modelos:	BD14, C33		

28,5x28,5mm			
			
1			
código	345942	referencia	28160024 28160273
descripción	interruptor pulsante medida de montaje 28,5x28,5mm gris 2CO 250V 16A empalme conector Faston 6,3mm temperatura ambiente máx. 150°C protección IP40		
Para modelos:	LP130, LP60, LP60H, LP61, LP61H, LP70		

			
1			
código	345953	referencia	28160273
descripción	interruptor pulsante medida de montaje 28,5x28,5mm gris 2CO 250V 16A empalme conector Faston 6,3mm temperatura ambiente máx. 150°C protección IP40		
Para modelos:	C44, C66, C77		





 <p>1</p>			
código	345940	referencia	28160020
descripción	pulsador medida de montaje 28,5x28,5mm gris 2CO 240V 16A empalme conector Faston 6,3mm temperatura ambiente máx. 150°C protección IP40		
Para modelos:	120, 160, 240, 42, 42E, 48, 48E, 55, 55E, 60, 882, 885, 904, 906, 908, 912, C44, C66, C77, LP130, LP60, LP60H, LP61, LP61H, LP70		

 <p>1</p>			
código	345941	referencia	28160022
descripción	pulsador medida de montaje 28,5x28,5mm gris 2CO 250V 16A bomba de desagüe empalme conector Faston 6,3mm temperatura ambiente máx. 150°C protección IP40		
Para modelos:	120, 160, 240, 42, 42E, 48, 48E, 55, 55E, 882, 885, 904, 906, 908, 912		

 <p>1</p>			
código	345947	referencia	28160037
descripción	pulsador medida de montaje 28,5x28,5mm gris 2CO 250V 16A bomba de desagüe empalme conector Faston 6,3mm temperatura ambiente máx. 150°C protección IP40		
Para modelos:	C44, C66, C77, D120, D30, D40, D40ELT, D80, D80F		

 <p>1</p>			
código	347990	referencia	28160045
descripción	pulsador medida de montaje 28,5x28,5mm gris 2CO 250V 16A regeneración empalme conector Faston 6,3mm		
Para modelos:	D35, D40i		

 <p>1</p>			
código	345943	referencia	28160026 28160272
descripción	pulsador medida de montaje 28,5x28,5mm gris 2CO 250V 16A reloj empalme conector Faston 6,3mm temperatura ambiente máx. 125/55°C protección IP40		
Para modelos:	B11, B15, BD11, BD13, BD22, BD50, BE35, BE40, BE50, BE50T, D120, D30, D35, D40, D40ELT, D40i, D40i-BT-BA, D80, D80F		

<p>28,5x77,5mm</p>  <p>1</p>			
código	345944	referencia	28160028 28160034
descripción	conmutadores combinados con enclavamiento medida de montaje 28,5x77,5mm gris 2CO 250V 16A interruptor principal empalme conector Faston 6,3mm temperatura ambiente máx. 85°C protección IP40		
Para modelos:	B11, B15, BD11, BD13, D30		

 <p>1</p>			
código	345954	referencia	28160274
descripción	conmutadores combinados con enclavamiento medida de montaje 28,5x77,5mm gris 2CO/2CO/2CO 250V 16A empalme conector Faston 6,3mm temperatura ambiente máx. 85°C protección IP40		
Para modelos:	C44, C66, C77		

 <p>1</p>			
código	345945	referencia	28160029 28160033
descripción	conmutadores combinados con enclavamiento medida de montaje 28,5x77,5mm gris 2CO/2CO/2CO 250V 16A interruptor principal/ programa/bomba de desagüe empalme conector Faston 6,3mm temperatura ambiente máx. 85°C protección IP40		
Para modelos:	CE24, D35, D40, D40i, D40i-BT-BA		

 <p>1</p>			
código	345180	referencia	28160021 28160023
descripción	conmutadores combinados medida de montaje 28,5x77,5mm gris 1CO/1CO/1CO 250V 16A empalme conector Faston 6,3mm temperatura ambiente máx. 85°C protección IP40		
Para modelos:	120, 160, 240, 882, 885, 904, 906, 908, 912, C44, C66, LP130, LP60, LP60H, LP61, LP61H, LP70, SQ885, SQT80		



1

código	345946	referencia	28160036
descripción	conmutadores combinados medida de montaje 28,5x77,5mm gris 2CO/2CO/2CO 250V 16A flecha doble/flecha/interruptor principal empalme conector Faston 6,3mm temperatura ambiente máx. 85°C protección IP40		
Para modelos:	D120, D40ELT, D80, D80F		

otros



1

código	345952	referencia	28160044
descripción	pulsador gris 2CO 250V 16A sin marco aclarado empalme conector Faston 6,3mm temperatura ambiente máx. 85°C		
Para modelos:	B11, BD11, BD13, BD50, BE35, BE40		



1

código	345951	referencia	28160043
descripción	pulsador gris 2CO 250V 16A sin marco vaciado empalme conector Faston 6,3mm temperatura ambiente máx. 85°C		
Para modelos:	B11, BD11, BD13, BD22, BD50, BE35, BE40, BE50, BE50T		

microinterruptores

accionado por palanca



1

código	345178	referencia	25190003
descripción	microinterruptor con manilla 250V 16A 1CO empalme conector Faston 6,3mm L 28mm L1 37mm temperatura ambiente máx. 125°C distancia de sujeción 22mm fuerza de accionamiento: 220g longitud de palanca 33mm		
Para modelos:	120, 160, 240, 885, 904, 906, 908, 912, C44, C66, C77, D40i, D40i-BT-BA, D40i-ELT-BT-BA, EB12, EB12+12, EB6, EB6+6, EB8, EM12, EM12+12, EM20, EM20+20, ES12, ES20, ESD12, ESD20, FE12, FE20, FE20+20, FE30, FE30+30, KES20, KESD20, ST12, ST12+12, ST7, ST7+7		



1

código	345255	referencia	25190007
descripción	microinterruptor con manilla 250V 16A 1CO empalme conector Faston 6,3mm L 35mm L1 28mm temperatura ambiente máx. 125°C distancia de sujeción 22mm fuerza de accionamiento: 136g longitud de palanca 27mm		
Para modelos:	B11, BD11, BD13, BD14, BD14alt, BD22, C34, C34dgt, C44, C44dgt, C44dgt-elt, C66, C66dgt, C66dgt-elt, C77, CE24, D30, D40, D40ELT, D40ELT-BT-BA, D80, D80F, EN, ST4, ST6		



1

código	345183	referencia	25190005
descripción	microinterruptor con palanca doble 250V 16A 2CO empalme conector Faston 6,3mm L 50mm temperatura ambiente máx. 125°C distancia de sujeción 22.5mm tipo N16 fuerza de accionamiento: 290g longitud de palanca 47mm		
Para modelos:	42, 42E, 48, 48E, 55, 60, C33, C44, C66, C77, CW650-15, CW650-16, CW650-35, CW650-36		

accionados por palanca de rodillo

forma especial



1

código	345186	referencia	00000639 00006390 25190001
descripción	microinterruptor con palanca de rodillo 250V 15A 1CO empalme conector Faston 6,3mm L 42mm temperatura ambiente máx. 85°C longitud de palanca 37mm		
Para modelos:	120, 160, 240, 885, SQ885, SQT80		

accesorios



1

código	511081	referencia	00011100
descripción	accionador microinterruptor		
Para modelos:	42, 42E, 48, 48E, 55, 60		



1

código	511111	referencia	00006410
descripción	accionador microinterruptor Kit		



1

código	511119	referencia	00011090
descripción	accionador microinterruptor Kit		
Para modelos:	120, 160, 240, SQ885, SQT80		



1

código	511892	referencia	00011115
descripción	accionador para microinterruptor Kit		
Para modelos:	885, 904, 906, 908, 912		



1 			
código	511112	referencia	00006401 640H
descripción	palanca para microinterruptor		
Para modelos:	E500, MR600		

interruptores posicionales

LOVATO

1 			
código	347579	referencia	25190004
descripción	interruptor de posición plástico 1NO/1NC 400V 3A L 110mm An 30mm H 44mm protección IP66/67 fuerza de accionamiento: 380g unión roscada M16 distancia de sujeción 22mm tipo ZCP21		
Para modelos:	ET, ETE20, ETE21, ETE25, ETE27, ETS15		

TELEMECANIQUE (EFA)

1 			
código	347579	referencia	25190004
descripción	interruptor de posición plástico 1NO/1NC 400V 3A L 110mm An 30mm H 44mm protección IP66/67 fuerza de accionamiento: 380g unión roscada M16 distancia de sujeción 22mm tipo ZCP21		
Para modelos:	ET, ETE20, ETE21, ETE25, ETE27, ETS15		

1 			
código	347903	referencia	00073790 25190002
descripción	interruptor de posición plástico 1NO/1NC 400V 3A L 110mm An 30mm H 44mm protección IP66/67 fuerza de accionamiento: 380g unión roscada M16 distancia de sujeción 22mm tipo ZCP21		
Para modelos:	D40i, D40i-ELT-BT-BA, EN, ET, ET020, ETA, LP100, LP145, LPE100, LPE145		

interruptores de sistema ROLD

1 			
código	345651	referencia	28160253
descripción	elemento de conmutación 2CO 250V 16A empalme conector Faston 6,3mm		

1 			
código	347504	referencia	28160275
descripción	elemento de conmutación 2CO 250V 16A empalme conector Faston 6,3mm		
Para modelos:	CE24		

1 			
código	346233	referencia	28160205 28160210 28160218 28160219
descripción	tapón ciego ø 23.3mm gris		
Para modelos:	BD50, BE35, BE40, BE50, BE50T		

1 			
código	346255	referencia	28160202
descripción	tecla ø 23mm gris bomba de desagüe		
Para modelos:	BE35, BE40, BE50		

1 			
código	346253	referencia	28160213
descripción	tecla ø 23mm gris interruptor principal		
Para modelos:	BD50, BE35, BE40, BE50, CE24		

1 			
código	346256	referencia	28160214
descripción	tecla ø 23mm gris reloj sin lente		
Para modelos:	BD50, BE35, BE40, BE50, CE24		





			
1			
código	347193	referencia	28160250
descripción	unidad de pulsador 1NO 250V 16A empalme conector Faston 6,3mm		
Para modelos:	BD14alt, BD50, BE35, BE40, BE50		

conmutadores giratorios

BRETER

conmutadores giratorios

			
1			
código	345165	referencia	25100102 old version
descripción	conmutador giratorio 16A 2 polos		

			
1			
código	345015	referencia	00005980
descripción	conmutador giratorio 16A empalme borne roscado 3 polos eje 5x5mm		

			
1			
código	345166	referencia	25120001 old version
descripción	conmutador giratorio 4 polos		

TECNOMATIC

			
1			
código	345016	referencia	0000597A 25100001
descripción	conmutador giratorio 2 0-1 juegos de contactos 1 tipo HD1201R000 600V 12A eje ø 5x5mm eje L 23mm eje cuadrado empalme atornillado		
Para modelos:	EB12, EB12+12, EB18P, EB6, EB6+6, EB8, EM12, EM12+12, EM20, EM20+20, EM20+20-900, EM20-900, EM35, EM40-900, ES12, ES20, ESD12, ESD20, FE12, FE20, FE20+20, FE30, FE30+30, KES20, KESD20, ST12, ST12+12, ST7, ST7+7		

INTERRUPTORES Y PULSADORES ELFRAMO



			
1			
código	347055	referencia	25100102
descripción	conmutador giratorio 2 0-1 juegos de contactos 2 tipo HD1602R000 600V 16A eje ø 5x5mm eje L 23mm eje cuadrado empalme atornillado		
Para modelos:	120, 160, 240, 42, 42E, 48, 48E, 55, 55E, 60, 882, 885, 904, 906, 908, 912, C44, C66, CW650-15, CW650-16, CW650-35, CW650-36, SQ885, SQT80		

interruptores magnéticos

36x13mm

			
1			
código	345955	referencia	25110113
descripción	interruptor magnético L 36mm An 13mm empalme cable		
Para modelos:	42, 42E, 48, 48E, 55, 55E, 882, 885, B11, B15, BD46, BD47, BD50, BE35, BE40, BE50, BE50T, D120, D120dgt, D30, D35, D36, D45, D85, ETE20, ETE21, ETE25, ETE27, ETS15, LP60, LP60H, LP61, LP61H		

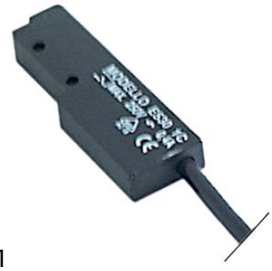
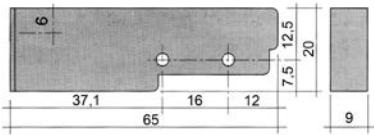
65x20mm

			
1			
			
código	345116	referencia	25240003
descripción	interruptor magnético L 65mm An 20mm 1NO 250V 0.4A P máx. 100W empalme cable longitud del cable 3000mm		
Para modelos:	EN, ET, ET020, ETA, ETE20, ETE21, ETE25, ETE27, LP130, LP70, LPE100, LPE145		
accesorios para	345116		
			
	código	345399	referencia
			—
	imán ø 3.3mm L 40mm H 8mm An 13mm dist. del agujero 30mm M3		



accesorios

imanes

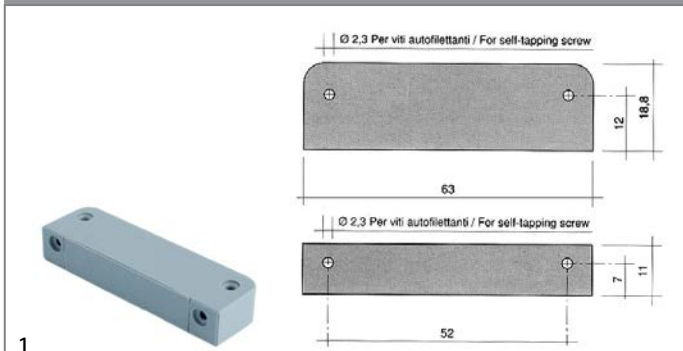

código	519049	referencia	25110115
descripción	imán ømm L 63mm H 10.7mm An 18.8mm dist. del agujero 52mm M2 agujero ø 2mm		
Para modelos:	ETE20, ETE21, ETE25, ETE27, ETS15		
accesorios para	519049		
	código	560095	referencia
			—
	tornillos de chapa ø 2.9mm L 9.5mm inox UE 20 pzs DIN 7981/ISO 7049 ø cabezal 5.6mm cabeza gota de sebo		

otros

	código	347904	referencia	00065606
	descripción	placa de retención L 62mm An 26mm para interruptor magnético		
	Para modelos:	LP60, LP60H, LP61, LP61H		

aparatos de mando y aviso

TELEMECANIQUE (EFA)

serie ZB4

interruptor completo

	código	346925	referencia	00061070
	descripción	selector giratorio medida de montaje ø22mm con enclavamiento blanco iluminado ángulo de rotación 90° secuencia de conmutación 0-1		
	Para modelos:	EN, ET, ET020, ETA, ETE20, ETE21, ETE25, ETE27, ETS15, LPE100, LPE145		
	repuestos para	346925		
	código	347385	referencia	—
				bloque de contacto EFA ZBE-101 1NO máx. 230V 10(6)A negro



código	347905	referencia	00061060
descripción	selector giratorio medida de montaje ø22mm con enclavamiento blanco iluminado secuencia de conmutación 0-1		
Para modelos:	ETS15, LP130, LP60, LP60H, LP61, LP61H, LP70		

lámparas

lámparas de señalización

lámparas de señalización 3 piezas (casquillo, lente y bombilla)

lámparas

bombillas incandescentes

	código	359236	referencia	00006460 28130003
	descripción	bombilla incandescente casquillo E10 24V 3W ø 10mm L 28mm		

lámparas de señalización completas

ø 6mm

	código	359005	referencia	28100006
	descripción	lámpara de señalización ø 6mm 230V amarillo longitud del cable 400mm		
	Para modelos:	120, 160, 240, 42, 42E, 48, 48E, 55, 55E, 60, 882, 885, 904, 906, 908, 912, C44, C66, CW650-15, CW650-16, CW650-35, CW650-36, SQ885, SQT80		

ø10mm

con casquillo enchufable

	código	359140	referencia	28100007
	descripción	lámpara de señalización ø 10mm amarillo 230V empalme conector Faston 6,3mm UE 1 pzs		
	Para modelos:	120, 160, 240, 42, 42E, 48, 48E, 55, 55E, 60, 882, 885, 904, 906, 908, 912, B11, B15, C44, C66, LP70, SQ885, SQT80		



ø12mm

con casquillo roscado



1

código	359048	referencia	28110100 28110101
descripción	lámpara de señalización ø 12mm 230V amarillo empalme conector Faston 6,3mm		
Para modelos:	D35, D40ELT, D40i, D40i-BT-BA		

ø13mm

con casquillo roscado



1

código	359146	referencia	28100011
descripción	lámpara de señalización ø 13mm 230V amarillo		
Para modelos:	B11, BD11, BD13, BD14, BD14alt, BD22, BD50, BE35, BE40, BE50, BE50T, C33, C34, C34dgt, C44, C66, C77, CE24, CW650-15, CW650-16, CW650-35, CW650-36, D120, D30, D35, D36, D40, D40i, D40i-BT-BA, D45, D80, D80F, LP130, LP60, LP60H, LP61, LP61H		

accesorios para 359146



código 510302 referencia —

junta tórica EPDM int.ø 12.42mm espesor 1.78mm UE 1 pzs



código 511505 referencia —

junta tórica EPDM espesor 1.78mm int.ø 12.42mm UE 10 pzs



1

código	359049	referencia	28100001
descripción	lámpara de señalización ø 13mm 400V verde		
accesorios para	359049		
	código 510302	referencia	—
	junta tórica EPDM int.ø 12.42mm espesor 1.78mm UE 1 pzs		
	código 511505	referencia	—
	junta tórica EPDM espesor 1.78mm int.ø 12.42mm UE 10 pzs		

con casquillo enchufable



1

código	359119	referencia	28100004
descripción	lámpara de señalización ø 13mm verde 24V empalme conector Faston 6,3mm UE 1 pzs		

33x10mm



1

código	359451	referencia	00003321 28110002 28110002 + 00038828
descripción	lámpara de señalización medida de montaje 33,1x10,3mm 400V amarillo empalme conector Faston 6,3mm		
Para modelos:	EB12, EB12+12, EB18P, EB6, EB6+6, EB8, EM12, EM12+12, EM20, EM20+20, EM20+20-900, EM20-900, EM35, EM40-900, ES12, ES20, ESD12, ESD20, FE12, FE20, FE20+20, FE30, FE30+30, KES20, KESD20		



1

código	359452	referencia	00003320 28110001 28110001 + 00038828
descripción	lámpara de señalización medida de montaje 33,1x10,3mm 400V verde empalme conector Faston 6,3mm		
Para modelos:	120, 160, 240, 882, 885, EB12, EB12+12, EB18P, EB6, EB6+6, EB8, EM12, EM12+12, EM20, EM20+20, EM20+20-900, EM20-900, EM35, EM40-900, ES12, ES20, ESD12, ESD20, FE12, FE20, FE20+20, FE30, FE30+30, KES20, KESD20, SQ885, SQT80		

otros



1

código	357123	referencia	28100014
descripción	lámpara de señalización rojo 230V empalme cable ø 8mm		
Para modelos:	ST12, ST12+12, ST4, ST6, ST7, ST7+7		

lámpade

bombillas incandescentes

para lámparas de señalización



1

código	359236	referencia	00006460 28130003
descripción	bombilla incandescente casquillo E10 24V 3W ø 10mm L 28mm		



temporizadores

temporizadores de programa



1

código	360654	referencia	26100024
descripción	temporizador CDC 11804F1 motores 1 cámaras 4 tiempo de funcionamiento 120s aliment. 230V eje ømm eje Lmm		
Para modelos:	B11, BD11, BD13, BD14, BD14alt, BD22, BE35, BE40		



1

código	360653	referencia	26100023
descripción	temporizador CDC 11804F1 motores 1 cámaras 4 tiempo de funcionamiento 180s aliment. 230V		
Para modelos:	BD50, BE50, BE50T, D30		



1

código	360671	referencia	26100021
descripción	temporizador CDC 4905DV motores 2 cámaras 5 tiempo de funcionamiento 72s / 4,8min aliment. 230V eje ømm eje Lmm		
Para modelos:	C33, C44, C66, C77, D120, D40, D80, D80F		



1

código	360069	referencia	26100017
descripción	temporizador CROUZET motores 1 cámaras 4 tiempo de funcionamiento 120s aliment. 230V eje ømm eje Lmm N° fabricante 645/5245 tipo de motor 82340		
Para modelos:	42, 42E, 48, 48E, 55, 55E, B11, B15		





1

código	360068	referencia	26100019
descripción	temporizador CROUZET motores 1 cámaras 5 tiempo de funcionamiento 90s aliment. 230V eje ømm eje Lmm N° fabricante 645/5238 tipo de motor 82340		
Para modelos:	120, 160, 240, 882, 885, 904, 906, 908, 912, SQ885, SQT80		





1

código	360081	referencia	00005930 26100015
descripción	temporizador FIBER P25 motores 1 cámaras 4 tiempo de funcionamiento 120s aliment. 24V eje ø 5x5mm eje L 20mm N° fabricante P255204H313 tipo de motor M51B20L6400		
repuestos para	360081		
	código	360676	referencia —
	kit de motor piñón ø 6.8mm dientes 15 aliment. 24V tensión AC 50/60Hz sentido de rotación en sentido anti-horario ø motor 48mm H 18.5mm tipo motor UDS40NE1RNZ165 longitud del cable 150mm con soporte		





1

código	360304	referencia	26100022
descripción	temporizador FIBER P25 motores 2 cámaras 4 tiempo de funcionamiento 2min / 7,5min aliment. 230V eje ømm eje Lmm N° fabricante P255J04LXP8 tipo de motor M51BJ0R6400 / M51BJ0L6400		
Para modelos:	LP130, LP60, LP60H, LP61, LP61H, LP70		
repuestos para	360304		
	código	360673	referencia —
	kit de motor piñón ø 6.8mm dientes 15 aliment. 230V tensión AC 50/60Hz sentido de rotación en sentido horario ø motor 48mm H 18.5mm tipo motor UDS40NE1RNZ165 longitud del cable 150mm con soporte		
	código	360674	referencia —
	kit de motor piñón ø 6.8mm dientes 15 aliment. 230V tensión AC 50/60Hz sentido de rotación en sentido anti-horario ø motor 48mm H 18.5mm tipo motor UDS40NE1RNZ165 longitud del cable 150mm con soporte		





1

código	360303	referencia	26100021 (old version)
descripción	temporizador FIBER P25 motores 2 cámaras 5 tiempo de funcionamiento 72s / 4,8min aliment. 230V eje ømm eje Lmm N° fabricante P255J05ANM0 tipo de motor M51BJ0R6400 / M51BJ0L6400		
repuestos para	360303		
	código	referencia	—
	kit de motor piñón ø 6.8mm dientes 15 aliment. 230V tensión AC 50/60Hz sentido de rotación en sentido horario ø motor 48mm H 18.5mm tipo motor UDS40NE1RNZ165 longitud del cable 150mm con soporte		
	código	referencia	—
	kit de motor piñón ø 6.8mm dientes 15 aliment. 230V tensión AC 50/60Hz sentido de rotación en sentido anti-horario ø motor 48mm H 18.5mm tipo motor UDS40NE1RNZ165 longitud del cable 150mm con soporte		



1

código	360305	referencia	26100025
descripción	temporizador FIBER PWE motores 1 cámaras 1 tiempo de funcionamiento 20min aliment. 230V eje ømm eje Lmm N° fabricante PWE5J01L103 tipo de motor M51BJ0R6400		
Para modelos:	B11, BD11, BD13, BD14, BD14alt, BD22, BD50, BE35, BE40, BE50, BE50T		
repuestos para	360305		
	código	referencia	—
	kit de motor piñón ø 6.8mm dientes 15 aliment. 230V tensión AC 50/60Hz sentido de rotación en sentido horario ø motor 48mm H 18.5mm tipo motor UDS40NE1RNZ165 longitud del cable 150mm con soporte		



1

código	360203	referencia	26100011
descripción	temporizador FIBER P26 motores 1 cámaras 3 tiempo de funcionamiento 20min aliment. 230V eje ømm eje Lmm N° fabricante P265J03L103 tipo de motor M61B40R6400		



1

código	360300	referencia	26100024 (old version)
descripción	temporizador FIBER PWE motores 1 cámaras 4 tiempo de funcionamiento 120s aliment. 230V eje ømm eje Lmm N° fabricante PWE5J04302 tipo de motor M51BJ0R6400		
repuestos para	360300		
	código	referencia	—
	kit de motor piñón ø 6.8mm dientes 15 aliment. 230V tensión AC 50/60Hz sentido de rotación en sentido horario ø motor 48mm H 18.5mm tipo motor UDS40NE1RNZ165 longitud del cable 150mm con soporte		



1

código	360087	referencia	26100011
descripción	temporizador FIBER P26 motores 1 cámaras 3 tiempo de funcionamiento 20min aliment. 230V eje ømm eje Lmm N° fabricante P265J03L130 tipo de motor M61B40R6400		

contactores

GENERAL ELECTRIC (AEG)

contactores de potencia



1

código	380245	referencia	25130028
descripción	contactor de potencia AC1 25A 230VAC (AC3/400V) 9A/4kW contactos principales 3NO contactos auxiliares 1NC empalme empalme atornillado tipo AEG LS4K 01A tipo GE CL00A 301 H 85mm		
Para modelos:	EB12, EB12+12, EB18P, EB6, EB6+6, EB8, EM12, EM12+12, EM20, EM20+20, EM20+20-900, EM20-900, EM35, EM40-900, SQ885, SQT80		

1

código	380244	referencia	0000 25130028 25130031
descripción	contactor de potencia AC1 25A 230VAC (AC3/400V) 9A/4kW contactos principales 3NO contactos auxiliares 1NO empalme empalme atornillado tipo AEG LS4K 10A tipo GE CL00A 310		



1

código	380262	referencia	25130026
descripción	contactor de potencia AC1 32A 230VAC (AC3/400V) 17A/7,5kW contactos principales 3NO contactos auxiliares 1NC empalme empalme atornillado tipo AEG LS7K01A tipo GE CL02A 301 H 85mm		
Para modelos:	EM12, EM12+12, EM20, EM20+20, EM20+20-900, EM20-900, EM35, EM40-900, SQ885, SQT80		



1

código	380261	referencia	25130025
descripción	contactor de potencia AC1 32A 230VAC (AC3/400V) 17A/7,5kW contactos principales 3NO contactos auxiliares 1NO empalme empalme atornillado tipo AEG LS7K 10A tipo GE CL02A 310		
Para modelos:	EM12, EM12+12, EM20, EM20+20, EM20+20-900, EM20-900, EM35, EM40-900		

LOVATO

contactores de potencia



1

código	380083	referencia	25130037
descripción	contactor de potencia AC1 25A 230VAC (AC3/400V) 9A/4,2kW contactos principales 3NO contactos auxiliares 1NC empalme empalme atornillado tipo BF0901A230		
Para modelos:	BE50T, C44dgt, C44dgt-elt, C66dgt, C66dgt-elt, CE24, D36, D45, ES12, ESD12, ST12, ST12+12, ST7, ST7+7		



1

código	380717	referencia	25130038
descripción	contactor de potencia AC1 32A 230VAC (AC3/400V) 18A/7,5kW contactos principales 3NO contactos auxiliares 1NC empalme empalme atornillado tipo BF1801A230		
Para modelos:	D36, D45, ES12, ES20, ESD12, ESD20, ST12, ST12+12		

TELEMECANIQUE (Schneider Electric)

contactores de potencia



1

código	380820	referencia	00000628 00006280
descripción	contactor de potencia AC1 25A 230VAC (AC3/400V) 9A/4kW contactos principales 3NO contactos auxiliares 1NO/1NC empalme empalme atornillado tipo LC1D0900M7		
Para modelos:	120, 160, 240, 882, 885, C33, C34, C34dgt, C44, C44dgt, C44dgt-elt, C66, C66dgt, C66dgt-elt, C77, CW650-15, CW650-16, CW650-35, CW650-36, D120, D120dgt, D30, D35, D36, D40, D40ELT, D40i, D40i-BT-BA, D40i-ELT-BT-BA, D45, D80, D80F, D85, EB12, EB12+12, EB8, EG140S, EM12, EM12+12, EM20, EM20+20, ES12, ES20, ESD12, ESD20, ETS15, FE12, FE20, FE20+20, FE30...(Otros modelos se puede ver en la tienda web)		



1

código	380617	referencia	00060670
descripción	contactor de potencia AC1 25A 24VAC (AC3/400V) 9A/4kW contactos principales 3NO contactos auxiliares 1NO/1NC empalme empalme atornillado tipo LC1D09B7		
Para modelos:	Cybergel, EN, ET, ET020, ETA, ETE20, ETE21, ETE25, ETE27, ETS15		



1

código	380976	referencia	00000627 00006270
descripción	contactor de potencia AC1 32A 230VAC (AC3/400V) 18A/7,5kW contactos principales 3NO contactos auxiliares 1NO/1NC empalme empalme atornillado		
Para modelos:	C44dgt, C44dgt-elt, C66dgt, C66dgt-elt, D120dgt, D36, D45, D85, EB12, EB12+12, EM12, EM12+12, EM20, EM20+20, ES12, ES20, ESD12, ESD20, ETS15, FE20, FE20+20, FE30, FE30+30, KES20, KESD20, LP130, LP60, LP60H, LP61, LP61H, LP70		

contactos auxiliares



1

código	380821	referencia	00000627 (old version) 00006270 (old version)
descripción	contacto auxiliar contactos 1NO/1NC AC15 10A empalme atornillado tipo LA1DN11		

relés

relés de potencia

con sujeción riel DIN

lateral



1

código	380629	referencia	25240004	
descripción	relé de potencia FINDER 24VAC 16A 3CO empalme conector Faston 4,8mm riel DIN N° fabricante 60.33.8.024.0008			
Para modelos:	D120, EN, ET, ET020, ETA, LP60, LP70, LPE100, LPE145			
accesorios para	380629			
	código	380703	referencia	—
	adaptador para sujeción de brida apto para Finder serie de relés 62.			
	código	380811	referencia	—
	adaptador para lengüeta de sujeción apto para Finder serie de relés 62.			
	código	380954	referencia	—
	adaptador dist. del agujero 54mm lengüeta de sujeción apto para Finder serie de relés 62. L 41mm An 39mm H 49mm			
	código	381003	referencia	—
	adaptador para sujeción de barra DIN apto para Finder serie de relés 62.			
	código	381039	referencia	—
	adaptador para sujeción de barra DIN apto para Finder serie de relés 62.			

con lengüeta de sujeción

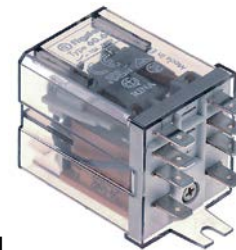

1

código	380626	referencia	25130101 25130102
descripción	relé de potencia FINDER 230VAC 10A 2CO empalme conector Faston 4,8mm lengüeta de sujeción N° fabricante 62.62.8.230.0000		
Para modelos:	C44, C66, C77, D120, D80, D80F, LP130, LP60, LP60H, LP61, LP61H, LP70		

1

código	380139	referencia	25130100
descripción	relé de potencia FINDER 230VAC 16A 2CO empalme F6,3 lengüeta de sujeción medidas 68x38,2x35,8mm N° fabricante 62.82.8.230.0000		
Para modelos:	42, 42E, 48, 48E, 55, 55E, 882, 885, B11, B15, BD46, BD50, BE35, BE40, BE50, BE50T, C34, C34dgt, C44dgt, C44dgt-elt, C66dgt, C66dgt-elt, CE24, D120dgt, D30, D36, D45, D85, LP70		



1

código	378280	referencia	22192002 22192005+22192006 22192009
descripción	controlador electrónico EVERY CONTROL medida de montaje 71x29mm profundidad de montaje 59mm aliment. 12V tensión AC/DC PTC con sensor protección IP65 -50 a +150°C display 4 dígitos longitud del cable 1430mm sonda ø 6mm 16 tipo EVK411		
Para modelos:	ETS15, LP130, LP60, LP60H, LP61, LP61H, LP70		

transformadores

transformadores encapsulados

PMA



1

código	379054	referencia	22192006
descripción	transformador primaria 230VAC secundaria 12VAC 3VA secundaria 0.25A H 40mm L 45mm An 50mm empalme atornillado 50/60Hz tipo 153/M		
Para modelos:	ETS15, LP130, LP60, LP60H, LP61, LP61H, LP70		

termómetros electrónicos

versión empotrada



1

código	379900	referencia	22191001 22192001
descripción	termómetro EVERY CONTROL tipo TM103T N4 medida de montaje 58x25,5mm 24V tensión AC -40 a +110°C entrada de medición NTC display 2½ dígitos dimensiones frontales 31x64mm protección IP54 precisión 1%		

controladores electrónicos

EVCO - EVERY CONTROL

controladores universales

versión empotrada



1

código	378270	referencia	22192001
descripción	controlador electrónico EVERY CONTROL medida de montaje 71x29mm profundidad de montaje 59mm aliment. 12/24V tensión AC/DC PTC salidas de relé 1 relé con sensor protección IP65 -50 a +150°C display 4 dígitos longitud del cable 1430mm 16 tipo EVK411		

SHANGFANG

accesorios



1

código	379054	referencia	22192006
descripción	transformador primaria 230VAC secundaria 12VAC 3VA secundaria 0.25A H 40mm L 45mm An 50mm empalme atornillado 50/60Hz tipo 153/M		
Para modelos:	ETS15, LP130, LP60, LP60H, LP61, LP61H, LP70		



sensores

sensores universales

sondas de temperatura



código	379142	referencia	22192003
descripción	sensor de temperatura PTC 1kOhm cable PVC sonda -50 a +150°C cable -10 a 100°C bulbo ø6x30mm longitud de cable 1.5m sin racor de dos hilos		
Para modelos:	ETE20, ETE21, ETE25, ETE27, ETS15, LP130, LP60, LP60H, LP61, LP61H, LP70		

sensores específicos del fabricante

sensores



código	378361	referencia	00590021
descripción	sensor de temperatura GCPTP-51F cable PTFE sonda °C cable -40 a +250°C empalme conector Faston 6,3mm rosca bulbo 20mm longitud de cable 24.5m		
Para modelos:	BD47, C44dgt, C44dgt-elt, C66dgt, C66dgt-elt, Cybergel, D120dgt, D36, D45, D85		



código	378343	referencia	25192400
descripción	sensor de temperatura NTC 10kOhm cable silicona sonda -40 a +110°C cable -50 a +180°C empalme de dos hilos rosca bulbo ø7x30mm longitud de cable 1m		
Para modelos:	BD47, C44, C44dgt, C44dgt-elt, C66, C66dgt, C66dgt-elt, C77, D40, D40ELT-BT-BA, D40i-ELT-BT-BA, D45, D85		

electrónicas

placas electrónicas



código	403919	referencia	25192041
descripción	placa electrónica		
Para modelos:	BD46, BD47		

código	403163	referencia	25192040
descripción	placa electrónica lavavajillas C34/C44/C66 230V 50/60A		
Para modelos:	C34, C34dgt, C44dgt, C44dgt-elt, C66dgt, C66dgt-elt, D120dgt, D36, D45, D85		

código	402990	referencia	25192020
descripción	placa electrónica lavavajillas D35/40		
Para modelos:	D35, D40i, D40i-BT-BA		

código	403775	referencia	25192030
descripción	platina de control sistemas de lavado D35/36/45/46/47 L 170mm An 28mm empalme conector codificado para ELFRAMO		
Para modelos:	BD46, BD47, C34, C34dgt, C44dgt, C44dgt-elt, C66dgt, C66dgt-elt, D120dgt, D36, D45, D85		

teclados

paneles de mando

código	109182	referencia	00038675
descripción	panel de mando freidora GW ELT/GWD ELT An 223mm H 70mm P 20mm		
Para modelos:	GSdT12, GSdT20, GST12, GST20, GVM35T, GW12ELT, GW209T, GW20ELT, GWD12ELT, GWD209T, GWD20ELT, GWDT12, GWDT20, GWT12, GWT20		

código	403262	referencia	00222433
descripción	panel de mando sistemas de lavado BE35 An 178mm H 48mm P 58mm para ELFRAMO		
Para modelos:	BD50, BE35, BE40, BE50		



válvulas magnéticas

válvulas magnéticas agua







ELBI















			
1			
código	370257	referencia	23120003
descripción	válvula magnética triple recto 230VAC entrada 3/4" salida 11,5mm T máx 90°C ELBI plástico reducción salida B 2.5l/min reducción salida B naranja		
Para modelos:	42, 42E, 48, 48E, 55, 55E, 60, B11, BD11, BD13, BD14, BD14alt, BD22, BD46, BD47, BD50, BE35, BE40, BE50, BE50T, D35, D36, D40, D40ELT, D40ELT-BT-BA, D40i, D40i-BT-BA, D40i-ELT-BT-BA, D45		



RPE

			
1			
código	374017	referencia	23120021
descripción	válvula magnética simple recto 230VAC entrada 3/4" salida 10mm reducción entrada A 6l/min DN10 RPE poliamida reducción entrada A blanco membrana NBR margen de presión 0,2-10bar		

TP

			
1			
código	370021	referencia	00003120 23120001
descripción	válvula magnética doble recto 230VAC entrada 3/4" salida 11,5mm DN10 TP reducción entrada A blanco		
Para modelos:	120, 160, 240, 42, 42E, 48, 48E, 55, 55E, 60, 882, 885, 904, 906, 908, 912, BD14, BD14alt, BD22, BD46, BD47, D40, D40ELT, SQ885, SQT80		
repuestos para	370021		
		código	371013 referencia —
	bobina magnética TP 230VAC 50/60Hz		
accesorios para	370021		
		código	371220 referencia —
	reducción TP velocidad de flujo 3l/min rojo tolerancia ±15%		
		código	371221 referencia —
	reducción TP velocidad de flujo 5.5l/min amarillo tolerancia ±15%		
		código	371222 referencia —
	reducción TP velocidad de flujo 6l/min gris tolerancia ±15%		
		código	371223 referencia —
	reducción TP velocidad de flujo 10l/min blanco tolerancia ±15%		



















accesorios para	370021		
		código	371224 referencia —
	reducción TP velocidad de flujo 12l/min bronce tolerancia ±15%		
		código	371225 referencia —
	reducción TP velocidad de flujo 16l/min marrón claro tolerancia ±15%		
		código	371226 referencia —
	reducción TP velocidad de flujo 20l/min rojo tolerancia ±15%		
		código	371230 referencia —
	reducción TP velocidad de flujo 0.25l/min rojo tolerancia ±25%		
		código	371231 referencia —
	reducción TP velocidad de flujo 0.35l/min violeta tolerancia ±25%		
		código	371232 referencia —
	reducción TP velocidad de flujo 0.5l/min naranja tolerancia ±25%		
		código	371233 referencia —
	reducción TP velocidad de flujo 0.8l/min blanco tolerancia ±25%		
		código	371234 referencia —
	reducción TP velocidad de flujo 1l/min azul claro tolerancia ±25%		
		código	371235 referencia —
	reducción TP velocidad de flujo 1.2l/min marrón tolerancia ±25%		
		código	371236 referencia —
	reducción TP velocidad de flujo 1.5l/min marrón claro tolerancia ±25%		
		código	371237 referencia —
	reducción TP velocidad de flujo 2.5l/min amarillo tolerancia ±25%		
		código	371238 referencia —
	reducción TP velocidad de flujo 3.4l/min verde oscuro tolerancia ±25%		
		código	371239 referencia —
	reducción TP velocidad de flujo 5l/min negro tolerancia ±25%		
		código	371240 referencia —
	reducción TP velocidad de flujo 8l/min azul tolerancia ±20%		

			
1			
código	370111	referencia	00003090 23120002
descripción	válvula magnética doble recto 24VAC entrada 3/4" salida 11,5mm DN10 TP		
Para modelos:	SQ885, SQT80		
repuestos para	370111		
		código	371035 referencia —
	bobina magnética 24VAC		

Continúa en la página siguiente





accesorios para 370111	
	código 371220 referencia — reducción TP velocidad de flujo 3l/min rojo tolerancia ±15%
	código 371221 referencia — reducción TP velocidad de flujo 5.5l/min amarillo tolerancia ±15%
	código 371222 referencia — reducción TP velocidad de flujo 6l/min gris tolerancia ±15%
	código 371223 referencia — reducción TP velocidad de flujo 10l/min blanco tolerancia ±15%
	código 371224 referencia — reducción TP velocidad de flujo 12l/min bronce tolerancia ±15%
	código 371225 referencia — reducción TP velocidad de flujo 16l/min marrón claro tolerancia ±15%
	código 371226 referencia — reducción TP velocidad de flujo 20l/min rojo tolerancia ±15%
	código 371230 referencia — reducción TP velocidad de flujo 0.25l/min rojo tolerancia ±25%
	código 371231 referencia — reducción TP velocidad de flujo 0.35l/min violeta tolerancia ±25%
	código 371232 referencia — reducción TP velocidad de flujo 0.5l/min naranja tolerancia ±25%
	código 371233 referencia — reducción TP velocidad de flujo 0.8l/min blanco tolerancia ±25%
	código 371234 referencia — reducción TP velocidad de flujo 1l/min azul claro tolerancia ±25%
	código 371235 referencia — reducción TP velocidad de flujo 1.2l/min marrón tolerancia ±25%
	código 371236 referencia — reducción TP velocidad de flujo 1.5l/min marrón claro tolerancia ±25%
	código 371237 referencia — reducción TP velocidad de flujo 2.5l/min amarillo tolerancia ±25%
	código 371238 referencia — reducción TP velocidad de flujo 3.4l/min verde oscuro tolerancia ±25%
	código 371239 referencia — reducción TP velocidad de flujo 5l/min negro tolerancia ±25%
	código 371240 referencia — reducción TP velocidad de flujo 8l/min azul tolerancia ±20%

  1			
código	370017	referencia	23120021
descripción	válvula magnética simple recto 230VAC entrada 3/4" salida 11,5mm DN10 TP p máx. 10bar		
repuestos para	370017		
	código 371013	referencia	—
bobina magnética TP 230VAC 50/60Hz			
accesorios para	370017		
	código 371220	referencia	—
reducción TP velocidad de flujo 3l/min rojo tolerancia ±15%			
	código 371221	referencia	—
reducción TP velocidad de flujo 5.5l/min amarillo tolerancia ±15%			
	código 371222	referencia	—
reducción TP velocidad de flujo 6l/min gris tolerancia ±15%			
	código 371223	referencia	—
reducción TP velocidad de flujo 10l/min blanco tolerancia ±15%			
	código 371224	referencia	—
reducción TP velocidad de flujo 12l/min bronce tolerancia ±15%			
	código 371225	referencia	—
reducción TP velocidad de flujo 16l/min marrón claro tolerancia ±15%			
	código 371226	referencia	—
reducción TP velocidad de flujo 20l/min rojo tolerancia ±15%			
	código 371230	referencia	—
reducción TP velocidad de flujo 0.25l/min rojo tolerancia ±25%			
	código 371231	referencia	—
reducción TP velocidad de flujo 0.35l/min violeta tolerancia ±25%			
	código 371232	referencia	—
reducción TP velocidad de flujo 0.5l/min naranja tolerancia ±25%			
	código 371233	referencia	—
reducción TP velocidad de flujo 0.8l/min blanco tolerancia ±25%			
	código 371234	referencia	—
reducción TP velocidad de flujo 1l/min azul claro tolerancia ±25%			
	código 371235	referencia	—
reducción TP velocidad de flujo 1.2l/min marrón tolerancia ±25%			
	código 371236	referencia	—
reducción TP velocidad de flujo 1.5l/min marrón claro tolerancia ±25%			
	código 371237	referencia	—
reducción TP velocidad de flujo 2.5l/min amarillo tolerancia ±25%			

Continúa en la página siguiente



accesorios para	370017		
	código	371238	referencia —
	reducción TP velocidad de flujo 3.4l/min verde oscuro tolerancia ±25%		
	código	371239	referencia —
	reducción TP velocidad de flujo 5l/min negro tolerancia ±25%		
	código	371240	referencia —
	reducción TP velocidad de flujo 8l/min azul tolerancia ±20%		



metal

SIRAI

2 vías

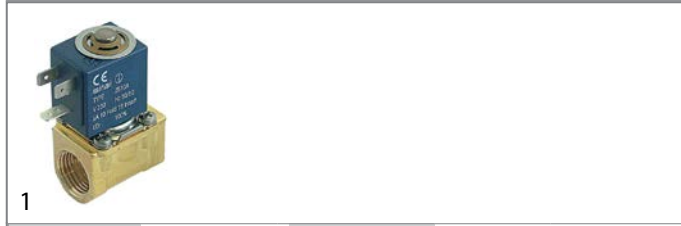
serie L140-B



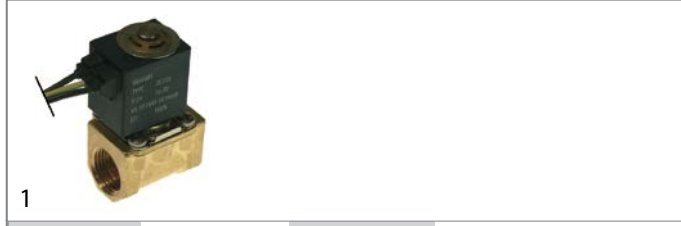

código	370239	referencia	23140006
descripción	válvula magnética 2vías 230VAC empalme 1/2" L 41mm DN 10mm conector hembra compacto -10 a +90°C SIRAI serie L140-B tipo de bobina Z610A membrana NBR (Wasser) p máx. 12bar p mín. 0.35bar		
Para modelos:	CW650-15, CW650-16, CW650-35, CW650-36, ETS15, LP130, LP70		
repuestos para	370239		
	código	371085	referencia —
	bobina magnética 230VAC 4VA SIRAI tipo de bobina ZB10A soporte ø 10mm 50/60Hz		
	código	371163	referencia —
	membrana empalme 1/2" serie L140-B tipo de membrana NBR (Wasser)		
accesorios para	370239		
	código	371091	referencia —
	enchufe tipo de conector DIN 43650B longitud del cable mm pequeño		



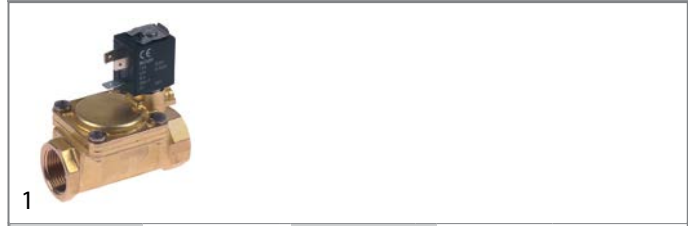

código	370472	referencia	23140004
descripción	válvula magnética 2vías 24VAC entrada 1/2" empalme 1/2" L 41mm DN 10mm -10 a +90°C SIRAI tipo de bobina Z610A membrana NBR (Wasser) p máx. 12bar p mín. 0.35bar 24V tensión AC		
Para modelos:	EN, ET, ET020, ETA, ETE20, ETE21, ETE25, ETE27, ETS15, LPE100, LPE145		

serie L180-B



código	370391	referencia	00056800 23150002
descripción	válvula magnética 2vías 24VAC empalme 3/4" L 79mm DN 18mm -10 a +90°C tipo de bobina Z610A membrana NBR (Wasser) p máx. 12bar p mín. 0.35bar		
accesorios para	370391		
	código	371091	referencia —
	enchufe tipo de conector DIN 43650B longitud del cable mm pequeño		





código	370329	referencia	00005692 23140003
descripción	válvula magnética 2vías 24VAC entrada 1/2" salida 1/2" empalme 1/2" L 66mm DN 13.5mm conector hembra compacto -10 a +90°C SIRAI serie L180-B tipo de bobina Z610A membrana NBR (Wasser) p máx. 12bar p mín. 0.35bar		
Para modelos:	ET, ETA		
repuestos para	370329		
	código	371070	referencia 00005661 23160001
	bobina magnética 24VAC 10VA SIRAI tipo de bobina Z610A soporte ø 10mm		
	código	371171	referencia —
	membrana serie L180-B tipo de membrana NBR (Wasser)		
accesorios para	370329		
	código	371091	referencia —
	enchufe tipo de conector DIN 43650B longitud del cable mm pequeño		



código	370252	referencia	00005680 23150002
descripción	válvula magnética 2vías 24VAC entrada 3/4" salida 3/4" L 79mm DN 18mm conector hembra compacto -10 a +90°C SIRAI serie L180-B tipo de bobina Z610A membrana NBR (Wasser) p máx. 12bar p mín. 0.35bar		
repuestos para	370252		
	código	371070	referencia 00005661 23160001
	bobina magnética 24VAC 10VA SIRAI tipo de bobina Z610A soporte ø 10mm		



Continúa en la página siguiente



repuestos para	370252		
	código	371172	referencia —
	membrana empalme 3/4" serie L180-B tipo de membrana NBR (Wasser)		
accesorios para	370252		
	código	371091	referencia —
	enchufe tipo de conector DIN 43650B longitud del cable mm pequeño		



1

código	370047	referencia	23140006
descripción	válvula magnética latón 2vías 230VAC entrada 1/2" salida 1/2" empalme 1/2" L 66mm DN 13.5mm conector hembra compacto -10 a +90°C SIRAI serie L180-B tipo de bobina Z610A membrana NBR (Wasser) p máx. 12bar p mín. 0.35bar 50/60Hz		
repuestos para	370047		
	código	371085	referencia —
	bobina magnética 230VAC 4VA SIRAI tipo de bobina ZB10A soporte ø 10mm 50/60Hz		
	código	371171	referencia —
	membrana serie L180-B tipo de membrana NBR (Wasser)		
accesorios para	370047		
	código	371091	referencia —
	enchufe tipo de conector DIN 43650B longitud del cable mm pequeño		



válvulas magnéticas vapor (agua)

2 vías

serie L145-R





1

código	370318	referencia	00056600 23150001 23160001
descripción	válvula magnética 2vías 24VAC entrada 1/2" salida 1/2" empalme 1/2" L 66mm DN 10mm conector hembra compacto -60 a +170°C SIRAI serie L145-R tipo de bobina Z614A membrana PTFE (vapor) p máx. 8bar p mín. 0.4bar		
repuestos para	370318		
	código	371158	referencia —
	bobina magnética 24VAC 10VA SIRAI tipo de bobina Z614A soporte ø 10mm		
	código	371164	referencia —
	membrana empalme 3/8"-1/2" serie L145-R tipo de membrana PTFE		
accesorios para	370318		
	código	371091	referencia —
	enchufe tipo de conector DIN 43650B longitud del cable mm pequeño		

serie L153-D



1

código	370264	referencia	23150003
descripción	válvula magnética 2vías 230VAC entrada 1/2" salida 1/2" empalme 1/2" L 66mm DN 11.5mm conector hembra DIN -10 a 140°C SIRAI serie L153-D tipo de bobina Z134A membrana EPDM (vapor/agua) p máx. 8bar p mín. 0.1bar		
Para modelos:	LP130		
repuestos para	370264		
	código	371077	referencia —
	bobina magnética 230VAC 24VA SIRAI tipo de bobina Z110A/Z114A/Z134A soporte ø 14mm		
	código	371167	referencia —
	membrana empalme 1/2" serie L153-D tipo de membrana EPDM		
accesorios para	370264		
	código	371090	referencia —
	enchufe tipo de conector DIN 43650A atornillado		



1

código	370327	referencia	23150004
descripción	válvula magnética 2vías 24VAC empalme 1" L 105mm DN 22mm -10 a 140°C SIRAI tipo de bobina Z923A membrana EPDM (vapor/agua) p máx. 8bar p mín. 0.1bar		





1

código	370325	referencia	00005660 23150001
descripción	válvula magnética 2vías 24VAC entrada 3/4" salida 3/4" empalme 3/4" L 79mm DN 17mm conector hembra DIN -10 a 140°C SIRAI serie L153-D tipo de bobina Z134A membrana EPDM (vapor/agua) p máx. 8bar p mín. 0.1bar 50Hz		
Para modelos:	EN, ET, ET020, ETA, ETE20, ETE21, ETE25, ETE27, LPE100, LPE145		

recambios y accesorios

solenoides

 <p>1</p>			
código	371070	referencia	00005661 23160001
descripción	bobina magnética 24VAC 10VA SIRAI tipo de bobina Z610A soporte ø 10mm		
Para modelos:	ET, ETA, LPE100, LPE145		
accesorios para	371070		
 <p>código 371091 referencia —</p> <p>enchufe tipo de conector DIN 43650B longitud del cable mm pequeño</p>			

diversas válvulas magnéticas

 <p>1</p>			
código	370738	referencia	00065310
descripción	válvula magnética 230VAC entrada 3/4" M salida 1" M L 225mm con filtro de suciedad SIRAI tipo de bobina Z610A 230V latón sistemas de lavado tensión AC		
Para modelos:	LP130, LP70		

presostatos

para sistemas de lavado

ø58mm con conector Faston 6,3mm
con empalme horizontal

 <p>1</p>			
código	541314	referencia	27100002
descripción	presostato margen de presión 46/26mbar empalme 6mm ø 58mm conexión de presión horizontal sistemas de lavado empalme presión ø 6mm		
Para modelos:	B11, B15, BD11, BD13, BD14, BD22, BD46, BD47, BD50, BE35, BE40, BE50, BE50T, C33, D30, D35, D36, D40, D40ELT, D40i, D40i-BT-BA, D45, D80, D80F		

 <p>1</p>			
código	541006	referencia	27100001
descripción	presostato margen de presión 60/20mbar empalme 6mm ø 58mm conexión de presión horizontal sistemas de lavado empalme presión ø 6mm		

 <p>1</p>			
código	541019	referencia	00005960
descripción	presostato margen de presión 70/30mbar empalme 6mm ø 58mm conexión de presión horizontal sistemas de lavado empalme presión ø 6mm		

electródos

 <p>1</p>			
código	403264	referencia	00013897
descripción	electrodo de nivel longitud total 125mm acodado ø 4mm		
Para modelos:	BD47, C44, C44dgt, C44dgt-elt, C66, C66dgt, C66dgt-elt, C77, D40, D40ELT, D40ELT-BT-BA, D40i-BT-BA, D40i-ELT-BT-BA, D45, D85		

 <p>1</p>			
código	403263	referencia	00014133
descripción	electrodo de nivel longitud total 75mm acodado ø 4mm		
Para modelos:	BD47, C44, C44dgt, C44dgt-elt, C66, C66dgt, C66dgt-elt, C77, D40, D40ELT, D40ELT-BT-BA, D40i-ELT-BT-BA, D45, D85		





**bombas****bombas de lavado y aclarado**

FIR

bombas







1

código	500927	referencia	00002501
descripción	bomba entrada \varnothing 53mm salida \varnothing 44mm tipo 0213.1600 230V 50/60Hz fases 1 1kW 1.36PS L 290mm dirección de rodadura derecho condensador 12.5 μ F FIR		
repuestos para	500927		
	código	365014	referencia 00002630
	condensador de servicio capacidad 12.5 μ F 450V tolerancia 5%Hz temperatura ambiente máx. -25 a + 85°C \varnothing 35mm L 70mm M8 plástico empalme conector Faston 6,3mm 45S.C3DS.12,5 protección		
	código	509010	referencia 00002860
	rotor \varnothing 105mm H 20mm M10L dirección de rodadura derecho palas 4		
	código	510693	referencia 00000300 00003000 06150001
	sello mecánico para árbol \varnothing 12mm anillo deslizante \varnothing ext. 24mm anillo deslizante H 15.5mm anillo deslizante \varnothing int. 11mm contraarandela montaje \varnothing 24mm altura contraarandela 8mm contraarandela \varnothing int. 13.5mm		
	código	521543	referencia 00002700
	cubierta de bomba ELFRAMO entrada \varnothing 53mm salida \varnothing 44mm sentido de rotación derecho \varnothing 160mm int. \varnothing 136mm altura interior 34mm		
	código	521717	referencia 00000290 00002900 06140008 06140140
	junta tórica EPDM espesor 1.78mm int. \varnothing 120.37mm UE 1 pzs		



1

código	500098	referencia	00002520 00002521 00002529 00071930 00071960
descripción	bomba entrada \varnothing 62mm salida \varnothing 49mm tipo B215.2500 230/400V 50/60Hz fases 3 1.5kW 2PS L 332mm dirección de rodadura derecho FIR		
Para modelos:	120, 160, 906, 908, C44, C66, C66dgt, C66dgt-elt, C77, D120, D120dgt, ET, ETA, ETS15		
repuestos para	500098		
	código	510693	referencia 00000300 00003000 06150001
	sello mecánico para árbol \varnothing 12mm anillo deslizante \varnothing ext. 24mm anillo deslizante H 15.5mm anillo deslizante \varnothing int. 11mm contraarandela montaje \varnothing 24mm altura contraarandela 8mm contraarandela \varnothing int. 13.5mm		
	código	511148	referencia 00000287 00002870
	rotor \varnothing 118mm H 20mm M10L		
	código	521544	referencia 00002710
	cubierta de bomba entrada \varnothing 63mm salida \varnothing 50mm sentido de rotación derecho \varnothing 180mm int. \varnothing 165mm altura interior 42mm		
	código	521718	referencia 00002910 06140010
	junta tórica EPDM espesor 3.53mm int. \varnothing 164.7mm UE 1 pzs		



1

código	499051	referencia	00002513
descripción	bomba entrada \varnothing 62mm salida \varnothing 50mm tipo B214 230V 50/60Hz fases 1 1kW dirección de rodadura derecho condensador 12.5 μ F FIR		
Para modelos:	120, 160, 906, 908, C44, C44dgt, C44dgt-elt, C66, C77, D120		
repuestos para	499051		
	código	referencia	00002630
	condensador de servicio capacidad 12.5 μ F 450V tolerancia 5%Hz temperatura ambiente máx. -25 a + 85°C \varnothing 35mm L 70mm M8 plástico empalme conector Faston 6,3mm 45S.C3DS.12,5 protección		
	código	referencia	00002860
	rotor \varnothing 105mm H 20mm M10L dirección de rodadura derecho palas 4		
	código	referencia	00000300 00003000 06150001
	sello mecánico para árbol \varnothing 12mm anillo deslizante \varnothing ext. 24mm anillo deslizante H 15.5mm anillo deslizante \varnothing int. 11mm contraarandela montaje \varnothing 24mm altura contraarandela 8mm contraarandela \varnothing int. 13.5mm		
	código	referencia	03100008
	tuerca rosca M8 H 6.5mm EC 13 inox DIN/ISO DIN 934 / ISO 4032/8673 UE 1 pzs		
	código	referencia	00002710
	cubierta de bomba entrada \varnothing 63mm salida \varnothing 50mm sentido de rotación derecho \varnothing 180mm int. \varnothing 165mm altura interior 42mm		
	código	referencia	00002910 06140010
	junta tórica EPDM espesor 3.53mm int. \varnothing 164.7mm UE 1 pzs		
	código	referencia	—
	arandela int. \varnothing 10.5mm \varnothing ext. 20mm espesor 2mm inox UE 1 pzs DIN 125A para rosca M10		

INSERT STAR

bombas



1

código	499270	referencia	20160040
descripción	bomba entrada \varnothing 38mm salida \varnothing 38mm tipo 2/102FA15 220/240V 50/60Hz fases 1 0.26kW L 200mm dirección de rodadura derecho INSERTSTAR		
Para modelos:	BE40		
repuestos para	499270		
	código	referencia	—
	junta tórica EPDM espesor 3.53mm int. \varnothing 94.84mm UE 1 pzs		
	código	referencia	00000300 00003000 06150001
	sello mecánico para árbol \varnothing 12mm anillo deslizante \varnothing ext. 24mm anillo deslizante H 15.5mm anillo deslizante \varnothing int. 11mm contraarandela montaje \varnothing 24mm altura contraarandela 8mm contraarandela \varnothing int. 13.5mm		
	código	referencia	—
	rotor \varnothing 75mm H 27mm tipo bomba 2/102FA15 soporte de eje \varnothing 8mm dirección de rodadura derecho rosca M8L para INSERTSTAR palas 6		
accesorios para	499270		
	código	referencia	—
	condensador de servicio capacidad 6 μ F 400V tolerancia 5% 50/60Hz temperatura ambiente máx. -25 a + 85°C \varnothing 31.5mm L 55mm M8 plástico empalme conector Faston 6,3mm protección		

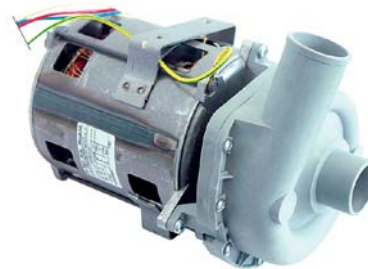





1

código	500320	referencia	20160042
descripción	bomba entrada \varnothing 38mm salida \varnothing 38mm tipo 2/123/FA30 230V 50Hz fases 1 0.59kW 0.8PS L 235mm dirección de rodadura derecho condensador 10 μ F INSERTSTAR		
Para modelos:	BD50, BE50, BE50T		
repuestos para	500320		
	código	referencia	00000300 00003000 06150001
	sello mecánico para árbol \varnothing 12mm anillo deslizante \varnothing ext. 24mm anillo deslizante H 15.5mm anillo deslizante \varnothing int. 11mm contraarandela montaje \varnothing 24mm altura contraarandela 8mm contraarandela \varnothing int. 13.5mm		
	código	referencia	—
	cubierta de bomba FAGOR entrada \varnothing 38mm salida \varnothing 38mm		

Continúa en la página siguiente







repuestos para	500320		
	código	521255	referencia —
	rotor ø 88mm H 33mm M8L tipo bomba 2/123/FA30 árbol ø 12mm		
	código	532491	referencia —
	junta tórica EPDM espesor 3.53mm int.ø 120.2mm UE 1 pzs		
accesorios para	500320		
	código	365015	referencia 24100009
	condensador de servicio capacidad 10µF 400V tolerancia 5%Hz temperatura ambiente máx. -25 a + 85°C ø 35.5mm L 59mm M8 plástico empalme conector Faston 6,3mm protección		
	código	551227	referencia —
	conector Faston hembra tamaño 6,3x0,8mm 1,0-2,5mm ² recto CuZn gal Sn T máx 110°C UE 10 pzs		

LAFERT

bombas





1

código	500088	referencia	00002510 00025190 00071800
descripción	bomba entrada ø 62mm salida ø 50mm tipo AMEE 71Z AA2 230/400V 50/60Hz fases 3 0.75kW 1PS L 310mm dirección de rodadura derecho LAFERT		
Para modelos:	C44, C44dgt, C44dgt-elt, C66, C77, D120, EN, ET, ET020, ETA, ETE20, ETE21, ETE25, ETE27		
repuestos para	500088		
	código	509010	referencia 00002860
	rotor ø 105mm H 20mm M10L dirección de rodadura derecho palas 4		
	código	510693	referencia 00000300 00003000 06150001
	sello mecánico para árbol ø 12mm anillo deslizante ø ext. 24mm anillo deslizante H 15.5mm anillo deslizante ø int. 11mm contraarandela montaje ø 24mm altura contraarandela 8mm contraarandela ø int. 13.5mm		
	código	511132	referencia 00002770
	parte inferior de tapa de boma		
	código	517174	referencia 03100008
	tuerca rosca M8 H 6.5mm EC 13 inox DIN/ISO DIN 934 / ISO 4032/8673 UE 1 pzs		
	código	521544	referencia 00002710
	cubierta de bomba entrada ø 63mm salida ø 50mm sentido de rotación derecho ø 180mm int.ø 165mm altura interior 42mm		
	código	521718	referencia 00002910 06140010
	junta tórica EPDM espesor 3.53mm int.ø 164.7mm UE 1 pzs		
	código	560312	referencia —
	arandela int.ø 10.5mm ø ext. 20mm espesor 2mm inox UE 1 pzs DIN 125A para rosca M10		







1

código	500097	referencia	00002523
descripción	bomba entrada ø 62mm salida ø 50mm tipo AMM80Z/A2 230V 50Hz fases 1 1.5kW 2PS L 320mm dirección de rodadura derecho condensador 25µF LAFERT		
Para modelos:	120, 160, 906, 908, C44, C66, C66dgt, C66dgt-elt, C77, D120, D120dgt		
repuestos para	500097		
	código	511148	referencia 00000287 00002870
	rotor ø 118mm H 20mm M10L		
	código	521544	referencia 00002710
	cubierta de bomba entrada ø 63mm salida ø 50mm sentido de rotación derecho ø 180mm int.ø 165mm altura interior 42mm		

LGB



1

código	499204	referencia	20160048
descripción	bomba entrada ø 28mm salida ø 26mm tipo ZF119SX 230V 50Hz fases 1 0.15kW 0.2PS L 195mm dirección de rodadura derecho condensador 5µF presión secundaria 12mm LGB		
Para modelos:	C34, C34dgt, C44, C44dgt, C44dgt-elt, C66, C66dgt, C66dgt-elt, C77, D120, D120dgt, D80, D85, LP61, LP61H		
repuestos para	499204		
	código	365017	referencia —
	condensador de servicio capacidad 5µF 450V tolerancia 5% 50/60Hz temperatura ambiente máx. -25 a + 85°C ø 28mm L 54mm M8 plástico empalme conector Faston 6,3mm 16.10.08 protección		
	código	510703	referencia 06150006
	sello mecánico para árbol ø 13mm anillo deslizante H 13mm altura contraarandela 5.5mm ø ext. 26mm		
	código	521057	referencia 20161002
	cubierta de bomba LGB entrada ø 28mm salida ø 26mm presión secundaria 12mm presión secundaria abierto sentido de rotación derecho ø 102mm int.ø 77mm altura interior 31mm		
	código	521114	referencia —
	rotor ø 48mm H 17mm tipo bomba ZF119SX árbol ø 13mm longitud árbol 12mm		



Continúa en la página siguiente



repuestos para	499204		
	código	528800	referencia —
	junta tórica EPDM espesor 2.62mm int.ø 75.87mm UE 1 pzs		







código	501556	referencia	20160027
descripción	bomba entrada ø 28mm salida ø 26mm tipo ZF1195X 230V 50Hz fases 1 0.2kW 0.27PS L 186mm dirección de rodadura derecho condensador 5µF LGB		
Para modelos:	BE35		
repuestos para	501556		
	código	521057	referencia 20161002
	cubierta de bomba LGB entrada ø 28mm salida ø 26mm presión secundaria 12mm presión secundaria abierto sentido de rotación derecho ø 102mm int.ø 77mm altura interior 31mm		



código	500094	referencia	20160025
descripción	bomba entrada ø 28mm salida ø 26mm tipo ZF1315X 230V 50Hz fases 1 0.2kW 0.15PS L 195mm dirección de rodadura izquierdo condensador 6.3µF LGB		
Para modelos:	42, 42E, 48, 48E, 55, 55E, B11, BD11		
repuestos para	500094		
	código	365012	referencia 24100001
	condensador de servicio capacidad 6.3µF 450V tolerancia 5% 50Hz temperatura ambiente máx. -25 a + 85°C ø 30mm L 61mm M8 plástico empalme conector Faston 6,3mm protección		
	código	502266	referencia 20161000
	cubierta de bomba entrada ø 28mm salida ø 26mm		
	código	510703	referencia 06150006
	sello mecánico para árbol ø 13mm anillo deslizante H 13mm altura contraarandela 5.5mm ø ext. 26mm		

repuestos para	500094		
	código	521085	referencia —
	rotor ø 72mm H 17mm rosca M7L árbol ø 13mm longitud árbol 12mm palas 3		
	código	528800	referencia —
	junta tórica EPDM espesor 2.62mm int.ø 75.87mm UE 1 pzs		



código	500539	referencia	00202481
descripción	bomba entrada ø 28mm salida ø 26mm tipo ZF1705X 230V 50Hz fases 1 0.32kW 0.44PS L 200mm dirección de rodadura derecho condensador 8µF LGB		
Para modelos:	B15, BD13, BD14, BD14alt, BD46, BD47		
repuestos para	500539		
	código	509004	referencia 00210036
	rotor ø 71mm H 16mm M7L dirección de rodadura derecho árbol ø 13mm longitud árbol 13mm palas 8		
	código	510703	referencia 06150006
	sello mecánico para árbol ø 13mm anillo deslizante H 13mm altura contraarandela 5.5mm ø ext. 26mm		
	código	521057	referencia 20161002
	cubierta de bomba LGB entrada ø 28mm salida ø 26mm presión secundaria 12mm presión secundaria abierto sentido de rotación derecho ø 102mm int.ø 77mm altura interior 31mm		
	código	528800	referencia —
	junta tórica EPDM espesor 2.62mm int.ø 75.87mm UE 1 pzs		
accesorios para	500539		
	código	365013	referencia —
	condensador de servicio capacidad 8µF 400V tolerancia 5%Hz temperatura ambiente máx. -25 a + 85°C ø 31.5mm L 55mm M8 plástico empalme conector Faston 6,3mm protección		







1

código	500092	referencia	00202480
descripción	bomba entrada \varnothing 50mm salida \varnothing 44mm tipo W300SX 230V 50Hz fases 1 0.3kW 0.5PS L 170mm dirección de rodadura derecho condensador 10 μ F LGB		
Para modelos:	42, 42E, 48, 48E, 55, 55E, 60, BD22		
repuestos para	500092		
	código	365015	referencia 24100009
	condensador de servicio capacidad 10 μ F 400V tolerancia 5%Hz temperatura ambiente máx. -25 a + 85°C \varnothing 35.5mm L 59mm M8 plástico empalme conector Faston 6,3mm protección		
	código	510554	referencia —
	junta tórica EPDM espesor 2mm int. \varnothing 120mm UE 1 pzs		
	código	510607	referencia 00210029 00210032
	rotor \varnothing 85mm H 29mm soporte de eje \varnothing 9x8mm dirección de rodadura derecho palas 6		
	código	510693	referencia 00000300 00003000 06150001
	sello mecánico para árbol \varnothing 12mm anillo deslizante \varnothing ext. 24mm anillo deslizante H 15.5mm anillo deslizante \varnothing int. 11mm contraarandela montaje \varnothing 24mm altura contraarandela 8mm contraarandela \varnothing int. 13.5mm		
	código	511178	referencia 00202460
	parte inferior de tapa de boma		
	código	521564	referencia 00210028
	cubierta de bomba		



1

código	500093	referencia	00202485 00202486 20160062
descripción	bomba entrada \varnothing 50mm salida \varnothing 44mm tipo W500SX 230V 50Hz fases 1 0.5kW 0.7PS L 200mm dirección de rodadura derecho condensador 16 μ F LGB		
Para modelos:	42, 42E, 48, 48E, 55, 55E, 60, D30, D35, D36, D40, D40ELT, D40ELT-BT-BA, D40i, D40i-BT-BA, D40i-ELT-BT-BA, D45		
repuestos para	500093		
	código	365021	referencia 24100004
	condensador de servicio capacidad 16 μ F 425V tolerancia 5% 50/60Hz temperatura ambiente máx. -25 a + 85°C \varnothing 35mm L 73mm simple M8 plástico empalme conector Faston 6,3mm 416.10.99 protección		
	código	510607	referencia 00210029 00210032
	rotor \varnothing 85mm H 29mm soporte de eje \varnothing 9x8mm dirección de rodadura derecho palas 6		
	código	510693	referencia 00000300 00003000 06150001
	sello mecánico para árbol \varnothing 12mm anillo deslizante \varnothing ext. 24mm anillo deslizante H 15.5mm anillo deslizante \varnothing int. 11mm contraarandela montaje \varnothing 24mm altura contraarandela 8mm contraarandela \varnothing int. 13.5mm		
	código	521564	referencia 00210028
	cubierta de bomba		
	código	521717	referencia 00000290 00002900 06140008 06140140
	junta tórica EPDM espesor 1.78mm int. \varnothing 120.37mm UE 1 pzs		



código	499225	referencia	00002591 20160053
descripción	bomba entrada ø 50mm salida ø 50mm tipo ZF400VSX 230V 50Hz fases 1 0.81kW 1.1PS L 245mm dirección de rodadura derecho condensador 16µF C 34 dgt / C 44 dgt LGB		
Para modelos:	C34, C44dgt, CE24		
repuestos para	499225		
	código	referencia	24100004
	365021		
	condensador de servicio capacidad 16µF 425V tolerancia 5% 50/60Hz temperatura ambiente máx. -25 a + 85°C ø 35mm L 73mm simple M8 plástico empalme conector Faston 6,3mm 416.10.99 protección		
	código	referencia	06150006
	510703		
	sello mecánico para árbol ø 13mm anillo deslizando H 13mm altura contraarandela 5.5mm ø ext. 26mm		
	código	referencia	00004072 0000407B 05100008
	520454		
	abrazadera de tubo ø 70-90mm ancho 9mm UE 5 pzs DIN 3017		
	código	referencia	—
	521090		
	rotor ø 101mm H 32mm rosca M8L árbol ø 13mm longitud árbol 12mm		
	código	referencia	—
	521548		
	cubierta de bomba LGB entrada ø 50mm salida ø 50mm		
	código	referencia	—
	532623		
	junta tórica EPDM espesor 2.62mm int.ø 120.32mm UE 1 pzs		

OLYMPIA

bombas

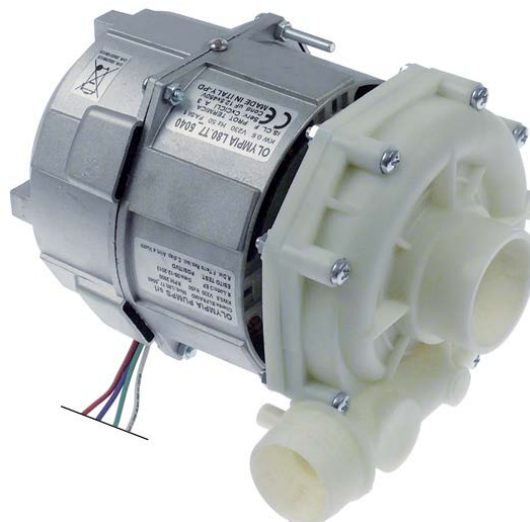



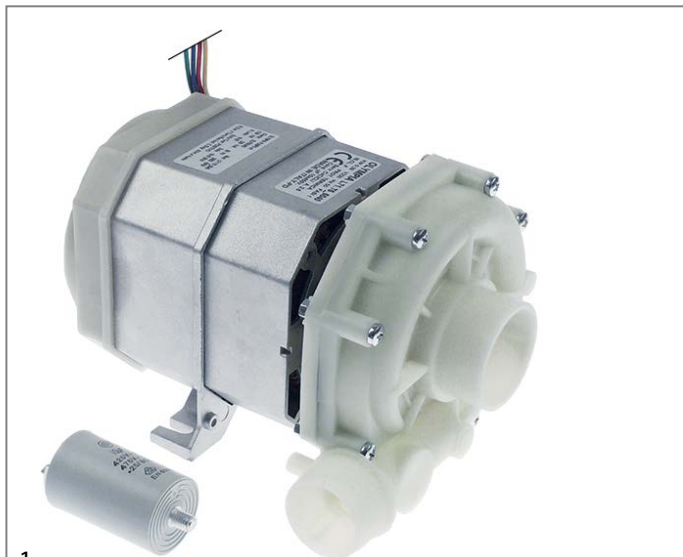

código	499217	referencia	20160063
descripción	bomba entrada ø 50mm salida ø 40mm tipo L80.T7_5040 230V 50Hz fases 1 0.6kW 0.8PS L 205mm dirección de rodadura derecho condensador 12.5µF D 85 dgt OLYMPIA		
repuestos para	499217		
	código	referencia	00002630
	365014		
	condensador de servicio capacidad 12.5µF 450V tolerancia 5%Hz temperatura ambiente máx. -25 a + 85°C ø 35mm L 70mm M8 plástico empalme conector Faston 6,3mm 45S.C3DS.12,5 protección		
	código	referencia	—
	510554		
	junta tórica EPDM espesor 2mm int.ø 120mm UE 1 pzs		
	código	referencia	00000300 00003000 06150001
	510693		
	sello mecánico para árbol ø 12mm anillo deslizando ø ext. 24mm anillo deslizando H 15.5mm anillo deslizando ø int. 11mm contraarandela montaje ø 24mm altura contraarandela 8mm contraarandela ø int. 13.5mm		
	código	referencia	20161004
	512415		
	cubierta de bomba OLYMPIA entrada ø 50mm salida ø 40mm		
	código	referencia	—
	517368		
	rotor ø 102mm H 21mm dirección de rodadura derecho rosca M10L para Dihr palas 8		





1

código	499314	referencia	20160062
descripción	bomba entrada \varnothing 50mm salida \varnothing 41mm tipo L71T5_5040 230V 50Hz fases 1 0.38kW L 200mm dirección de rodadura derecho condensador 10 μ F OLYMPIA		
repuestos para	499314		
	código	365015	referencia 24100009
	condensador de servicio capacidad 10 μ F 400V tolerancia 5%Hz temperatura ambiente máx. -25 a + 85°C \varnothing 35.5mm L 59mm M8 plástico empalme conector Faston 6,3mm protección		
	código	510554	referencia —
	junta tórica EPDM espesor 2mm int. \varnothing 120mm UE 1 pzs		
	código	510693	referencia 00000300 00003000 06150001
	sello mecánico para árbol \varnothing 12mm anillo deslizante \varnothing ext. 24mm anillo deslizante H 15.5mm anillo deslizante \varnothing int. 11mm contraarandela montaje \varnothing 24mm altura contraarandela 8mm contraarandela \varnothing int. 13.5mm		
	código	512415	referencia 20161004
	cubierta de bomba OLYMPIA entrada \varnothing 50mm salida \varnothing 40mm		
	código	521157	referencia 20161501
	rotor \varnothing 82mm H 22mm rosca M10L		





1



código	499338	referencia	20160072
descripción	bomba entrada \varnothing 62mm salida \varnothing 50mm tipo MEC71.T120SX 220-240/380-415V 50Hz fases 3 0.88kW 1.2PS L 310mm dirección de rodadura derecho OLYMPIA		
repuestos para	499338		
	código	510693	referencia 00000300 00003000 06150001
	sello mecánico para árbol \varnothing 12mm anillo deslizante \varnothing ext. 24mm anillo deslizante H 15.5mm anillo deslizante \varnothing int. 11mm contraarandela montaje \varnothing 24mm altura contraarandela 8mm contraarandela \varnothing int. 13.5mm		
	código	521152	referencia 20161100
	cubierta de bomba OLYMPIA entrada 62 \varnothing 190mm		
	código	521153	referencia 20161003
	carcasa de bomba OLYMPIA salida \varnothing 52mm		
	código	521154	referencia 06140046
	junta tórica int. \varnothing 152.7mm espesor 2.62mm EPDM UE 1 pzs		









1

código	542117	referencia	20160066
descripción	bomba entrada \varnothing 62mm salida \varnothing 52mm tipo L80.T200SX 230V 50Hz fases 1 1.5kW L 340mm dirección de rodadura derecho condensador 17/17 μ F OLYMPIA		
repuestos para	542117		
	código	521152	referencia 20161100
	cubierta de bomba OLYMPIA entrada 62 \varnothing 190mm		
	código	521153	referencia 20161003
	carcasa de bomba OLYMPIA salida \varnothing 52mm		

Continúa en la página siguiente

repuestos para	542117		
	código	521154	referencia 06140046
	junta tórica int.ø 152.7mm espesor 2.62mm EPDM UE 1 pzs		
	código	521155	referencia 20161500 20161506
	rotor ø 107mm H 34mm tipo bomba OLYMPIA rosca M8L palas 6		
accesorios para	542117		
	código	542157	referencia 00018280
	soporte para bomba de lavado L 267mm An 132mm H 43mm		



código	499226	referencia	20160061
descripción	bomba entrada ø 62mm salida ø 52mm tipo MEC80.T200SX 230/400V 50Hz fases 3 1.5kW 2PS L 340mm dirección de rodadura derecho OLYMPIA		
Para modelos:	C66dgt		
repuestos para	499226		
	código	510693	referencia 00000300 00003000 06150001
	sello mecánico para árbol ø 12mm anillo deslizante ø ext. 24mm anillo deslizante H 15.5mm anillo deslizante ø int. 11mm contraarandela montaje ø 24mm altura contraarandela 8mm contraarandela ø int. 13.5mm		
	código	521152	referencia 20161100
	cubierta de bomba OLYMPIA entrada 62 ø 190mm		
	código	521153	referencia 20161003
	carcasa de bomba OLYMPIA salida ø 52mm		
	código	521154	referencia 06140046
	junta tórica int.ø 152.7mm espesor 2.62mm EPDM UE 1 pzs		
	código	521155	referencia 20161500 20161506
	rotor ø 107mm H 34mm tipo bomba OLYMPIA rosca M8L palas 6		
accesorios para	499226		
	código	542157	referencia 00018280
	soporte para bomba de lavado L 267mm An 132mm H 43mm		

bombas de aumento de presión I



código	500540	referencia	20160001 20160054
descripción	bomba entrada ø 1" F salida ø 1" F tipo PKM60 230V 50Hz fases 1 0.37kW PEDROLLO 0.5HP		
Para modelos:	120, 160, 240, 882, 885, 904, 906, 908, 912, C33, C34, C34dgt, C44, C44dgt, C44dgt-elt, C66, C66dgt, C66dgt-elt, C77, D120, D120dgt, D80, D80F, D85, LP130, LP60, LP60H, LP61, LP61H, LP70, SQ885, SQT80		
accesorios para	500540		
	código	365015	referencia 24100009
	condensador de servicio capacidad 10µF 400V tolerancia 5%Hz temperatura ambiente máx. -25 a + 85°C ø 35.5mm L 59mm M8 plástico empalme conector Faston 6,3mm protección		



código	499067	referencia	20160003
descripción	bomba entrada ø 1" F salida ø 1" F tipo PKM60 230V 60Hz fases 1 0.37kW 0.5PS L 247mm dirección de rodadura izquierdo condensador 10µF PEDROLLO		
Para modelos:	120, 160, 240, 882, 885, 904, 906, 908, 912, C33, C34, C34dgt, C44, C44dgt, C44dgt-elt, C66, C66dgt, C66dgt-elt, C77, D120, D120dgt, D80, D85, LP130, LP60, LP60H, LP61, LP61H, LP70, SQ885, SQT80		



código	499308	referencia	20160056
descripción	bomba entrada ø 1" F salida ø 1" F tipo PQM60 220V 60Hz fases 1 0.37kW 0.5PS L 195mm dirección de rodadura izquierdo condensador 10µF PEDROLLO		
Para modelos:	C34, C44dgt, C66dgt		



1

código	499145	referencia	00047030 20160004 20160055
descripción	bomba entrada ø 1" salida ø 1" tipo PQ60 230/400V 50Hz fases 3 0.37kW PEDROLLO		
Para modelos:	EN, ET, ETA, ETE20, ETE21, ETE25, ETE27, ETS15, LPE100, LPE145		



1

código	500395	referencia	20160011 20160016
descripción	bomba entrada ø 3/8" H salida ø 3/8" H tipo PS45DX 230V 50Hz 0.35kW condensador 8µF LGB		
Para modelos:	B11, BD11, BD13, BD14, BD14alt, BD22, BD46, BD47, BD50, BE50, D30, D35, D36, D40, D40ELT, D40ELT-BT-BA, D40i, D40i-ELT-BT-BA, D45, D80, LP60, LP60H		
repuestos para	500395		
		código	365013
		referencia	—
	condensador de servicio capacidad 8µF 400V tolerancia 5%Hz temperatura ambiente máx. -25 a + 85°C ø 31.5mm L 55mm M8 plástico empalme conector Faston 6,3mm protección		
		código	698400
		referencia	—
	junta de tapa de bomba tipo bomba PS46 espesor 2mm int.ø 66mm UE 1 pzs		

bombas de salida

HANNING



1

código	500082	referencia	00002570
descripción	bomba de desagüe 230V 100W		
Para modelos:	882, 885, C33, C44, C66, C77, D30, D40, D80, D80F		

PLASET



1

código	500083	referencia	20160014
descripción	bomba de desagüe entrada ø 30mm salida ø 23mm 220-240V 34W 50Hz PLASET		
Para modelos:	42, 42E, 48, 48E, 55, 55E, 60, B11, BD11, BD13, BD14, BD14alt, BD22, BD46, BD47, BD50, BE35, BE40, BE50, BE50T, D30, D35, D36, D40, D40ELT, D40ELT-BT-BA, D40i, D40i-ELT-BT-BA, D45		

otros



1

código	499001	referencia	20160013
descripción	bomba de desagüe entrada ø 30mm salida ø 22mm 220V 34W 60Hz PLASET		
Para modelos:	BD13, BD14, BD50, BE35, BE40, BE50, BE50T, D35, D36, D40, D40i, D40i-ELT-BT-BA, D45		

bombas de aumento de presión II

accesorios



1

código	365015	referencia	24100009
descripción	condensador de servicio capacidad 10µF 400V tolerancia 5%Hz temperatura ambiente máx. -25 a + 85°C ø 35.5mm L 59mm M8 plástico empalme conector Faston 6,3mm protección		



1

código	365012	referencia	24100001
descripción	condensador de servicio capacidad 6.3µF 450V tolerancia 5% 50Hz temperatura ambiente máx. -25 a + 85°C ø 30mm L 61mm M8 plástico empalme conector Faston 6,3mm protección		



condensadores y filtros antiparasitarios

condensadores de servicio

plástico



1

código	365015	referencia	24100009
descripción	condensador de servicio capacidad 10µF 400V tolerancia 5%Hz temperatura ambiente máx. -25 a + 85°C ø 35.5mm L 59mm M8 plástico empalme conector Faston 6,3mm protección		



1

código	365014	referencia	00002630
descripción	condensador de servicio capacidad 12.5µF 450V tolerancia 5%Hz temperatura ambiente máx. -25 a + 85°C ø 35mm L 70mm M8 plástico empalme conector Faston 6,3mm 45S.C3DS.12,5 protección		
Para modelos:	120, 160, 882, 885, C44, C66		



1

código	365021	referencia	24100004
descripción	condensador de servicio capacidad 16µF 425V tolerancia 5% 50/60Hz temperatura ambiente máx. -25 a + 85°C ø 35mm L 73mm simple M8 plástico empalme conector Faston 6,3mm 416.10.99 protección		
Para modelos:	42, 42E, 48, 48E, 55, 55E, 60, BD22, C33, C34, C34dgt, C44, C44dgt, C44dgt-elt, C66, C77, CW650-15, CW650-16, CW650-35, CW650-36, D30, D35, D36, D40, D40ELT, D40ELT-BT-BA, D40i, D40i-BT-BA, D40i-ELT-BT-BA, D45, D80, D80F, D85		



1

código	365012	referencia	24100001
descripción	condensador de servicio capacidad 6.3µF 450V tolerancia 5% 50Hz temperatura ambiente máx. -25 a + 85°C ø 30mm L 61mm M8 plástico empalme conector Faston 6,3mm protección		

filtros

filtros antiparasitarios

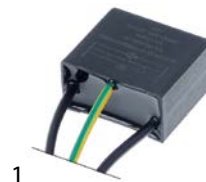

1

código	365026	referencia	00002650 24100100
descripción	filtro antiparasitario capacidad 0,47µF(X2)+2x0,01µF(Y2) 0.68MOhm		



1

código	365044	referencia	00002650 24100100
descripción	filtro antiparasitario tipo FC701Y2F 250V 50-60Hz conductor 2 con T empalme cable 200mm L 42mm ø 23mm Hmm Anmm plástico UE 1 pzs		



1

código	365089	referencia	24100102
descripción	filtro antiparasitario tipo X1+100R 250V capacidad 0.24µF		
Para modelos:	120, 885, 906, 908, C33, C34, C34dgt, C44, C44dgt, C44dgt-elt, C66, C66dgt, C66dgt-elt, C77, D35, D36, D40, D40i, D40i-ELT-BT-BA, D45, D80, D85, EM20, EM20+20, ES20, ESD20		

fusibles

fusibles finos



1

código	358041	referencia	00060970
descripción	fusible fino medida ø10x38mm 20A retardado nominal 400V tipo aM UE 1 pzs		
Para modelos:	EN, ET, ET020, ETA, LPE100, LPE145		



1

código	358030	referencia	00060980
descripción	fusible fino medida ø10x38mm 32A retardado nominal 400V tipo aM UE 1 pzs		
Para modelos:	EN, ET, ET020, ETA, LPE100, LPE145		

			
1			
código	358038	referencia	00060960 37130999
descripción	fusible fino medida ϕ 10x38mm 10A retardado nominal 500V tipo aM UE 1 pzs		
Para modelos:	120, 160, 240, 882, 885, 904, 906, 908, 912, CW650-15, CW650-16, CW650-35, CW650-36, Cybergel, EB12, EB12+12, EG140S, EM240, EM360, EM480, EM612, EM-HT, EN, ES12, ESD12, ET, ET020, ETA, ETE20, ETE21, ETE25, ETE27, ETS15, LPE100, LPE145, SQ885, SQT80		

			
2			
código	358040	referencia	00006261
descripción	fusible fino medida ϕ 10x38mm 16A retardado nominal 500V tipo aM UE 1 pzs		

portafusibles

			
1			
código	358075	referencia	00006121 37170001
descripción	portafusibles para para fusible ϕ 10x38mm fusible adaptable ϕ 10x38mm 1 polos 32A nominal 690V para barra DIN 35mm sección nominal 10mm ² apto para para fusible ϕ 10x38mm		
Para modelos:	120, 160, 240, 882, 885, 904, 906, 908, 912, Cybergel, EM240, EM360, EM480, EM612, EM-HT, EN, ET, ET020, ETA, ETE20, ETE21, ETE25, ETE27, ETS15, LPE100, LPE145, SQ885, SQT80		

accesorios eléctricos

cables

cables de cinta plana

grupo 1

			
1			
código	403776	referencia	25190105
descripción	cable de cinta plana 10 polos L 2600mm tipo de conector FC-10P medida reticular 2.54mm		
Para modelos:	BD46, BD47, C34, C34dgt, C44dgt, C44dgt-elt, C66dgt, C66dgt-elt, D120dgt, D36, D45, D85		

terminales

bloques de bornes



otros

			
1			
código	358505	referencia	00006260
descripción	borne seccionable 6-10mm ² 1 polos		

termostatos para gas

SIT

serie 710 Minisit

			
1			
código	107543	referencia	00034620
descripción	termostato de gas Kit SIT tipo MINISIT 710 T máx 190°C 110-190°C entrada gas 1/2" H salida gas 3/8" H conexión termopar M9x1 sonda ϕ 6mm sonda L 105mm capilar 1050mm regulador de presión no		
Para modelos:	FG125, FG157, FG159, FG307, FG309, GM12, GM12+12, GM20+20, GM20+20-900, GM25+25-900, GM25-900, GM35, GM50-900, GW-MODULARI		
repuestos para	107543		
	código	101135	referencia 00038639 16100006
	 termostato de gas SIT tipo MINISIT 710 T máx 190°C 110-190°C entrada gas 1/2" salida gas 3/8" conexión termopar M9x1 conexión de piloto M10x1 sonda ϕ 6mm sonda L 102mm capilar 1050mm tipo de sensor tipo A3 regulador de presión no regulador de presiónmbar prensaestopas		
	código	390730	referencia 161142 22170003
	 termostato de seguridad temp. desconexión 230°C 1 polos 0.5A sonda ϕ 4mm sonda L 125mm capilar 1550mm aislamiento del capilar 1410mm prensaestopas bulbo		



código	101434	referencia	00032390
descripción	termostato de gas sin accesorios SIT tipo MINISIT 710 T máx 190°C 110-190°C entrada gas 1/2" salida gas 3/8" conexión termopar M9x1 conexión de piloto M10x1 sonda ø 5mm sonda L 102mm capilar 1200mm tipo de sensor tipo G1 regulador de presión no regulador de presiónmbar prensaestopas		
Para modelos:	FG125, FG157, FG159, FG307, FG309, GM12, GM12+12, GM20+20, GM20+20-900, GM25+25-900, GM2532, GM2542, GM25-900, GM35, GM50-900, GMD2532, GMD2542, GW12, GW20, GWD12, GWD20, GW-MODULARI		
repuestos para	101434		
	código	101053	referencia —
	grupo magnético G1: M9x1 G2: M24x1 L 45mm ø 17mm apto para Minisit		
accesorios para	101434		
	código	100809	referencia —
	junta tórica EPDM espesor 2mm int.ø 21mm UE 1 pzs		
	código	100904	referencia —
	tornillo de apriete M10x1 para tuboø 4mm UE 1 pzs		
	código	100905	referencia —
	tornillo de apriete M10x1 para tuboø 6mm UE 1 pzs		
	código	101054	referencia —
	grupo magnético G1: M10x1 G2: M24x1 L 45mm ø 17mm apto para Minisit		
	código	101136	referencia 00032410
	encendedor piezoeléctrico apto para Minisit con tapa ømm empalme F6,3x0,8		
	código	101137	referencia —
	tapa sin piezoencendedor		
	código	101267	referencia —
	reducción H 3/8" M 1/2" L 21mm		
	código	101268	referencia —
	empalme de gas rosca 3/8" acodado con junta tórica MINISIT 710		
	código	101269	referencia —
	empalme de gas rosca 1/2" acodado con junta tórica MINISIT 710		
	código	101270	referencia —
	unión roscada H 3/8" M 3/8" L 28mm		
	código	101272	referencia —
	unión roscada H 1/2" M 3/8" L 57mm		
	código	101273	referencia —
	anillo cortante para tuboø 12mm L 9.5mm latón UE 1 pzs apto para universal		

accesorios para	101434		
	código	101274	referencia —
	anillo cortante para tuboø 16mm UE 1 pzs		
	código	101275	referencia —
	tornillo de racor rosca 1/2" para tuboø 16mm UE 1 pzs		
	código	101276	referencia —
	tornillo de racor rosca 3/8" tubo ø 12mm UE 1 pzs		
	código	110068	referencia 16100003
	pomo apto para Minisit ø 37mm		

código	101135	referencia	00038639 16100006
descripción	termostato de gas SIT tipo MINISIT 710 T máx 190°C 110-190°C entrada gas 1/2" salida gas 3/8" conexión termopar M9x1 conexión de piloto M10x1 sonda ø 6mm sonda L 102mm capilar 1050mm tipo de sensor tipo A3 regulador de presión no regulador de presiónmbar prensaestopas		
Para modelos:	GVM35, GW12, GW20, GWD12, GWD20		
repuestos para	101135		
	código	101053	referencia —
	grupo magnético G1: M9x1 G2: M24x1 L 45mm ø 17mm apto para Minisit		
	código	102118	referencia —
	sensor 110-190°C sonda ø 6mm sonda L 102mm capilar 1050mm T máx 190°C freidora tipo de sensor tipo A3 apto para MINISIT 710		
accesorios para	101135		
	código	100809	referencia —
	junta tórica EPDM espesor 2mm int.ø 21mm UE 1 pzs		
	código	100820	referencia —
	conducción para prensaestopas M M14x1,5 H M10x0,75 sonda ø máx. 6.5mm EC 22		
	código	100904	referencia —
	tornillo de apriete M10x1 para tuboø 4mm UE 1 pzs		
	código	100905	referencia —
	tornillo de apriete M10x1 para tuboø 6mm UE 1 pzs		
	código	101054	referencia —
	grupo magnético G1: M10x1 G2: M24x1 L 45mm ø 17mm apto para Minisit		
	código	101136	referencia 00032410
	encendedor piezoeléctrico apto para Minisit con tapa ømm empalme F6,3x0,8		
	código	101137	referencia —
	tapa sin piezoencendedor		

Continúa en la página siguiente



accesorios para		101135		
	código	101267	referencia	—
	reducción H 3/8" M 1/2" L 21mm			
	código	101268	referencia	—
	empalme de gas rosca 3/8" acodado con junta tórica MINISIT 710			
	código	101269	referencia	—
	empalme de gas rosca 1/2" acodado con junta tórica MINISIT 710			
	código	101270	referencia	—
	unión roscada H 3/8" M 3/8" L 28mm			
	código	101272	referencia	—
	unión roscada H 1/2" M 3/8" L 57mm			
	código	101273	referencia	—
	anillo cortante para tuboø 12mm L 9.5mm latón UE 1 pzs apto para universal			
	código	101274	referencia	—
	anillo cortante para tuboø 16mm UE 1 pzs			
	código	101275	referencia	—
	tornillo de racor rosca 1/2" para tuboø 16mm UE 1 pzs			
	código	101276	referencia	—
	tornillo de racor rosca 3/8" tubo ø 12mm UE 1 pzs			
	código	110068	referencia	16100003
	pomo apto para Minisit ø 37mm			

accesorios

sensores



código	102105	referencia	16100030
descripción	sensor 110-200°C sonda ø 6mm sonda L 102mm capilar 1050mm T máx 200°C freidora tipo de sensor tipo G1 apto para MINISIT 710		
Para modelos:	GM12, GM12+12, GM20+20, GM20+20-900, GM25+25-900, GM25-900, GM35, GM50-900		

válvulas de gas y centralitas de gas automáticas







válvulas de control de gas

SIT

NOVASIT













1

código	101187	referencia	16100005
descripción	válvula de gas SIT serie Novasit 820 aliment. 0.17VHz entrada gas 1/2" salida gas 1/2" conexión termopar M9x1 conexión de piloto M10x1 presión de encendidombar margen de presión 5-50mbar conexión del presostato ciego núm. Ref. 0.820.301 alimentación operador Millivolt		
Para modelos:	GSDT12, GSdT20, GST12, GST20, GVM35T, GW209T, GWD209T, GWDT12, GWDT20, GWT12, GWT20		
repuestos para	101187		
	código	101065	referencia —
	grupo magnético con cable L 44mm D1 ø 30mm D2 ø 20mm apto para NOVASIT		
accesorios para	101187		
	código	100110	referencia —
	piloto de encendido SIT tipo serie 190 3 llamas boquilla ømm empalme de gasmm		
	código	101305	referencia —
	empalme de gas recto 1/2" brida 45x45mm ELETTROSIT/V4400/4600/4605 para SIT/HONEYWELL dist. del agujero 36x36mm		
	código	101306	referencia —
	empalme de gas acodado brida 45x45mm dist. del agujero 36x36mm 1/2" ELETTROSIT/V4400/4600/4605 atornillado con junta tórica para SIT/HONEYWELL		
	código	101307	referencia —
	empalme de gas recto brida 45x45mm dist. del agujero 36x36mm 3/4" ELETTROSIT/V4400/4600/4605 atornillado con junta tórica para SIT/HONEYWELL		
	código	101308	referencia —
	empalme de gas acodado brida 45x45mm dist. del agujero 36x36mm 3/4" ELETTROSIT/V4400/4600/4605 atornillado con junta tórica para SIT/HONEYWELL		
	código	102116	referencia 17100002
	termogenerador ROBERTSHAW L 900mm sonda ø 9mm sonda L 57mm 250-750mV unión roscada 7/16"		



1

código	101956	referencia	16100020
descripción	válvula de gas SIT serie Novasit 820 aliment. 230V 50Hz entrada gas 1/2" salida gas 1/2" conexión termopar M9x1 conexión de piloto M10x1 presión de encendido margen de presión 5-50mbar conexión del presostato ciego núm. Ref. 0.820.031		
repuestos para	101956		
	código	101065	referencia —
	grupo magnético con cable L 44mm D1 ø 30mm D2 ø 20mm apto para NOVASIT		
	código	101313	referencia —
	bobina magnética 230V 50Hz		
accesorios para	101956		
	código	100006	referencia —
	encendedor piezoeléctrico apto para ELETROSIT cuerpo plástico soplado empalme ø2,4mm ø 14mm		
	código	101305	referencia —
	empalme de gas recto 1/2" brida 45x45mm ELETROSIT/V4400/4600/4605 para SIT/HONEYWELL dist. del agujero 36x36mm		
	código	101306	referencia —
	empalme de gas acodado brida 45x45mm dist. del agujero 36x36mm 1/2" ELETROSIT/V4400/4600/4605 atornillado con junta tórica para SIT/HONEYWELL		
	código	101307	referencia —
	empalme de gas recto brida 45x45mm dist. del agujero 36x36mm 3/4" ELETROSIT/V4400/4600/4605 atornillado con junta tórica para SIT/HONEYWELL		
	código	101308	referencia —
	empalme de gas acodado brida 45x45mm dist. del agujero 36x36mm 3/4" ELETROSIT/V4400/4600/4605 atornillado con junta tórica para SIT/HONEYWELL		
	código	101312	referencia —
	microinterruptor		
	código	101314	referencia —
	bobina magnética 24V 50Hz		
	código	101317	referencia —
	conector con cable L 1000mm apto para NOVASIT		
	código	101318	referencia —
	tapa para solenoide apto para NOVASIT		

encendidos y tempares

pilotos de encendido

SIT

serie 100







1

código	106906	referencia	33120005
descripción	piloto de encendido SIT tipo serie 100 3 llamas boquilla ø 0.2mm empalme de gas 6mm		
Para modelos:	FG125, FG157, FG159, FG307, FG309, GM2532, GM2542, GMD2532, GMD2542, GW12, GW20, GWD12, GWD20		
repuestos para	106906		
	código	100245	referencia —
	boquilla de quemador piloto gas licuado código 20 taladro ø 0.2mm UE 1 pzs rosca M8x0,75		
	código	100855	referencia —
	portapilotos triple		
	código	100885	referencia —
	casquillo de mezcla de aire para quemador piloto UE 1 pzs		
	código	100916	referencia —
	resorte de compresión para quemador piloto UE 1 pzs		
	código	100917	referencia —
	junta para quemador piloto UE 1 pzs aluminio		
	código	100918	referencia —
	tornillo para quemador piloto		
	código	107162	referencia —
	parte superior de quemador piloto SIT 3 llamas Hmm Lmm UE 1 pzs		
	código	107701	referencia —
	parte inferior de quemador piloto SIT serie 100 boquilla ø 0.2mm		
accesorios para	106906		
	código	100245	referencia —
	boquilla de quemador piloto gas licuado código 20 taladro ø 0.2mm UE 1 pzs rosca M8x0,75		
	código	100246	referencia —
	boquilla de quemador piloto gas natural taladro ø 0.35mm UE 1 pzs rosca M8x0,75		
	código	100904	referencia —
	tornillo de apriete M10x1 para tubo ø 4mm UE 1 pzs		
	código	100905	referencia —
	tornillo de apriete M10x1 para tubo ø 6mm UE 1 pzs		
	código	102110	referencia —
	tubo piloto cobre diámetro ø 4mm grosor de la pared 1mm L 3000mm		

Continúa en la página siguiente



accesorios para	106906			
	código	102111	referencia	—
	tubo piloto cobre diámetro ø 6mm grosor de la pared 1mm L 3000mm			
	código	107171	referencia	—
	boquilla de quemador piloto SIT gas natural/licuado taladro ø 0.25mm UE 1 pzs			
	código	107700	referencia	—
	parte inferior de quemador piloto SIT serie 100 boquilla ø 0.25mm			
	código	107702	referencia	—
	parte inferior de quemador piloto SIT serie 100 boquilla ø 0.35mm			

accesorios



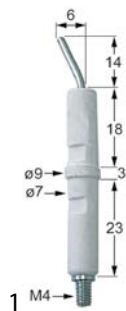

electródos de encendido











código	100706	referencia	33110002
descripción	electrodo de encendido empalme M4 UE 1 pzs		
Para modelos:	FG125, FG12M, FG157, FG159, FG24M, FG307, FG309, GB10, GBD10, GM2532, GM2542, GMD2532, GMD2542, GW12, GW12ELT, GW20, GW20ELT, GWD12, GWD12ELT, GWD20, GWD20ELT, GW-MODULARI		

serie 160



código	100049	referencia	00032790
descripción	piloto de encendido SIT tipo serie 160 2 llamas boquilla ømm empalme de gasmm		
Para modelos:	GM12, GM12+12, GM20+20, GM20+20-900, GM25+25-900, GM25-900, GM35, GM50-900, GVM35		
repuestos para	100049		
	código	100907	referencia 33120009
	unión roscada rosca M10x1 UE 1 pzs tipo SEF 1 ømm para termopar		
accesorios para	100049		
	código	100202	referencia —
	boquilla de quemador piloto gas natural código 41 UE 1 pzs boquilla ø 0.41mm		
	código	100203	referencia —
	boquilla de quemador piloto gas licuado código 25 UE 1 pzs boquilla ø 0.25mm		
	código	100701	referencia 33110001
	electrodo de encendido empalme M4 UE 1 pzs		
	código	100869	referencia —
	boquilla de quemador piloto gas natural código 51 UE 1 pzs apto para serie 160 boquilla ø 0.51mm		

accesorios para	100049			
	código	100906	referencia	33120004
	unión roscada rosca M10x1 para electrodo de encendido latón UE 1 pzs EC 10			
	código	100908	referencia	—
	tornillo de racor rosca M10x1 para tubo ø 4mm UE 1 pzs			
	código	100909	referencia	—
	tornillo de racor rosca M10x1 para tubo ø 6mm UE 1 pzs			
	código	101282	referencia	—
	anillo cortante para tubo ø 4mm L 7.4mm UE 1 pzs			
	código	101287	referencia	—
	anillo cortante para tubo ø 6mm UE 1 pzs			
	código	102110	referencia	—
	tubo piloto cobre diámetro ø 4mm grosor de la pared 1mm L 3000mm			
	código	102111	referencia	—
	tubo piloto cobre diámetro ø 6mm grosor de la pared 1mm L 3000mm			
	código	107650	referencia	00032680
	boquilla de quemador piloto SIT gas licuado código 30 UE 1 pzs			

serie 190



código	106722	referencia	00038491
descripción	piloto de encendido SIT tipo serie 190 3 llamas gas natural/licuado boquilla 35/51 boquilla ø 0,35/0,51mm empalme de gas 6mm completo con boquilla		
Para modelos:	GSDT12, GSDT20, GST12, GST20, GVM35T, GW209T, GWD209T, GWDT12, GWDT20, GWT12, GWT20		

POLIDORO

pilotos de encendido



código	104485	referencia	33120030
descripción	piloto de encendido POLIDORO 2 llamas gas natural código 29.2 empalme de gas 6mm		
Para modelos:	FG12M, FG24M, GB10, GBD10		



otros

código	106966	referencia	00038531
descripción	piloto de encendido 2 llamas gas natural/licuado boquilla \varnothing 0.45mm empalme de gas 6mm		
Para modelos:	GW12, GW12ELT, GW20, GW20ELT, GWD12, GWD12ELT, GWD20, GWD20ELT, GW-MODULARI		
repuestos para	106966		
	código	100855	referencia —
	portapilotos triple		
	código	100885	referencia —
	casquillo de mezcla de aire para quemador piloto UE 1 pzs		
	código	102742	referencia —
	boquilla de quemador piloto gas licuado código 25 taladro \varnothing 0.25mm UE 1 pzs		
	código	102973	referencia 18100093
	boquilla de quemador piloto gas natural taladro \varnothing 0.45mm UE 1 pzs		

código	100706	referencia	33110002
descripción	electrodo de encendido empalme M4 UE 1 pzs		
Para modelos:	FG125, FG12M, FG157, FG159, FG24M, FG307, FG309, GB10, GBD10, GM2532, GM2542, GMD2532, GMD2542, GW12, GW12ELT, GW20, GW20ELT, GWD12, GWD12ELT, GWD20, GWD20ELT, GW-MODULARI		

código	100906	referencia	33120004
descripción	unión roscada rosca M10x1 para electrodo de encendido latón UE 1 pzs EC 10		
Para modelos:	GSDT12, GSDT20, GST12, GST20, GVM35, GVM35T, GW209T, GWD209T, GWDT12, GWDT20, GWT12, GWT20		

electródos

código	102871	referencia	33110003
descripción	electrodo de encendido D1 \varnothing 7mm D2 \varnothing 9mm empalme M4 L1 8mm LC1 18mm LC2 3mm LC3 23mm para apretar		
Para modelos:	FG12M, FG24M, GB10, GBD10, GSDT12, GSDT20, GST12, GST20, GVM35T, GW209T, GWD209T, GWDT12, GWDT20, GWT12, GWT20		

código	100701	referencia	33110001
descripción	electrodo de encendido empalme M4 UE 1 pzs		
Para modelos:	GM12, GM12+12, GM20+20, GM20+20-900, GM25+25-900, GM25-900, GM35, GM50-900, GVM35		
accesorios para	100701		
	código	100906	referencia 33120004
	unión roscada rosca M10x1 para electrodo de encendido latón UE 1 pzs EC 10		

cables de encendido

cables prefabricados

código	100015	referencia	30140002
descripción	cable de encendido longitud del cable 600mm empalme \varnothing 2,4mm / \varnothing 2,4mm		
Para modelos:	FG12M, FG24M, GB10, GBD10, GM2532, GM2542, GMD2532, GMD2542, GW12, GW20, GWD12, GWD20		

código	100025	referencia	30140001
descripción	cable de encendido longitud del cable 600mm empalme \varnothing 4mm / F6,3mm		
Para modelos:	GVM35T, GW12ELT, GW209T, GW20ELT, GWD12ELT, GWD209T, GWD20ELT, GWDT12, GWDT20, GWT12, GWT20		

encendedores piezoeléctricos

diámetro de montaje 22mm



código	100005	referencia	33100003
descripción	encendedor piezoeléctrico cuerpo plástico soplado montaje ø 22mm empalme ø2,4mm longitud del cable mm SIT		
Para modelos:	FG12M, FG24M, GB10, GBD10, GM2532, GM2542, GMD2532, GMD2542, GW12, GW20, GW209T, GWD12, GWD20, GWD209T, GWDT12, GWDT20, GWT12, GWT20		

otros



código	fdp ¹	referencia	00032410
descripción	encendedor piezoeléctrico apto para Minisit con tapa ømm empalme F6,3x0,8		
Para modelos:	GM12, GM12+12, GM20+20, GM20+20-900, GM25+25-900, GM25-900, GM35, GM50-900		

repuestos para	101136		
	código	referencia	
	100001	00032460	00038700
		33100001	
	encendedor piezoeléctrico apto para Minisit empalme F6,3x0,8 ømm		

¹fuera de producción



código	fdp ¹	referencia	00032460 00038700 33100001
descripción	encendedor piezoeléctrico apto para Minisit empalme F6,3x0,8 ømm		
Para modelos:	FG125, FG157, FG159, FG307, FG309, GM12, GM12+12, GM20+20, GM20+20-900, GM25+25-900, GM25-900, GM35, GM50-900, GSdT12, GSdT20, GST12, GST20, GVM35, GVM35T, GW12, GW12ELT, GW20, GW209T, GW20ELT, GWD12, GWD12ELT, GWD20, GWD209T, GWD20ELT, GWDT12, GWDT20, GW-MODULARI, GWT12, GWT20		

¹fuera de producción

termopares

termopares insertables

termopares insertables con interrupción

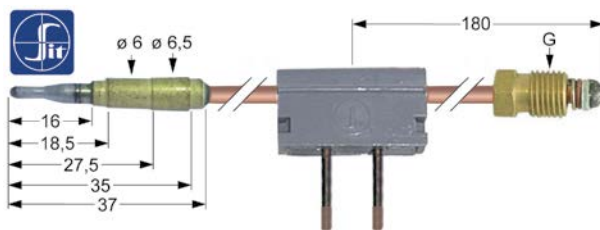

código	107234	referencia	159023 17100003
descripción	termopar SIT con interruptor M9x1 L 400mm clavija ø6,0mm conexión para soldadura		
Para modelos:	GSdT12, GSdT20, GST12, GST20, GVM35T, GWDT12, GWDT20, GWT12, GWT20		

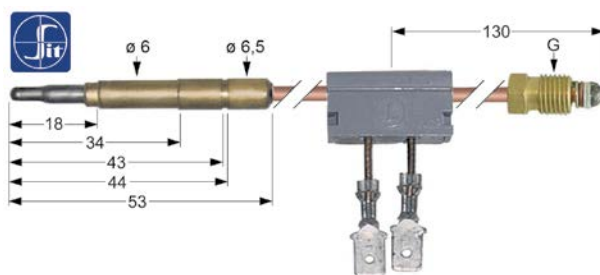

código	107177	referencia	00032580 17100001
descripción	termopar SIT con interruptor M9x1 L 600mm clavija ø6,0mm F 6,3mm		
Para modelos:	FG125, FG12M, FG157, FG159, FG24M, FG307, FG309, GB10, GBD10, GM12, GM12+12, GM20+20, GM20+20-900, GM25+25-900, GM2532, GM2542, GM25-900, GM35, GM50-900, GMD2532, GMD2542, GVM35, GW12, GW12ELT, GW20, GW209T, GW20ELT, GWD12, GWD12ELT, GWD20, GWD209T, GWD20ELT, GW-MODULARI		

termogeneradores

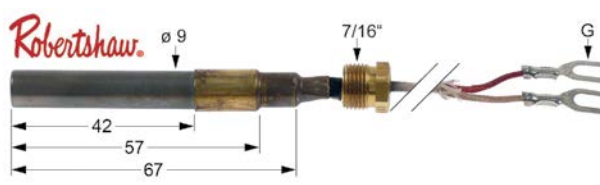

código	102116	referencia	17100002
descripción	termogenerador ROBERTSHAW L 900mm sonda ø 9mm sonda L 57mm 250-750mV unión roscada 7/16"		
Para modelos:	GSdT12, GSdT20, GST12, GST20, GVM35T, GW209T, GWD209T, GWDT12, GWDT20, GWT12, GWT20		



quemadores de gas

quemadores tubulares

quemadores tubulares



1

código	105384	referencia	15100004
descripción	quemador tubular 2 filas L 450mm An 240mm ømm H 310mm freidora		
Para modelos:	FG157, FG159, FG307, FG309, GM2542, GMD2542		



1

código	104483	referencia	15100010
descripción	quemador tubular ø 40mm Anmm Hmm L 340mm anchura brida 50mm longitud brida 62mm freidora		
Para modelos:	FG12M, FG24M, GB10, GBD10		



1

código	105430	referencia	15100008
descripción	quemador tubular ø 40mm Anmm Hmm L 340mm anchura brida 60mm longitud brida 76mm freidora		

boquillas de gas

inyectores principales

boquillas de gas M 10x1



1

código	100067	referencia	18110093 18110121
descripción	boquilla de gas rosca M10x1 EC 12 taladro ø 1.1mm G30 presión de gas 30mbar		
Para modelos:	FG12M, FG24M, GB10, GBD10, GSDT12, GSDT20, GST12, GST20, GW12, GW12ELT, GW209T, GW20ELT, GWD12, GWD12ELT, GWD209T, GWD20ELT, GWDT12, GWDT20, GW-MODULARI, GWT12, GWT20		

código	107343	referencia	18110111 18110130
descripción	boquilla de gas rosca M10x1 EC 12 taladro ø 1.2mm gas licuado presión de gas 30mbar		
Para modelos:	FG12M, FG24M, GB10, GBD10, GSDT12, GSDT20, GST12, GST20, GW209T, GWD209T, GWDT12, GWDT20, GWT12, GWT20		

código	106290	referencia	18110090 18110095 18110110
descripción	boquilla de gas rosca M10x1 EC 12 taladro ø 1.85mm interior puntiagudo		
Para modelos:	FG157, FG159, FG307, FG309, GM2532, GM2542, GMD2532, GMD2542, GW20, GWDT12, GWDT20, GW-MODULARI, GWT12, GWT20		

boquillas piloto

boquillas piloto POLIDORO

código	100000	referencia	18100060
descripción	boquilla de quemador piloto POLIDORO gas licuado código 22 taladro ø 0.22mm UE 1 pzs		
Para modelos:	FG12M, FG24M, GB10, GBD10		

código	104486	referencia	18100061
descripción	boquilla de quemador piloto POLIDORO gas natural código 29.2 taladro ø 2x0,29mm UE 1 pzs		
Para modelos:	FG12M, FG24M, GB10, GBD10		

boquillas piloto SIT

serie 100

código	102973	referencia	18100093
descripción	boquilla de quemador piloto gas natural taladro ø 0.45mm UE 1 pzs		
Para modelos:	GW12, GW12ELT, GW20, GW20ELT, GWD12, GWD20		



serie 160



1

código	107172	referencia	18100094
descripción	boquilla de quemador piloto SIT gas licuado código 25 UE 1 pzs		
Para modelos:	GW12, GW12ELT, GW20, GW20ELT, GWD12, GWD20		



1

código	107650	referencia	00032680
descripción	boquilla de quemador piloto SIT gas licuado código 30 UE 1 pzs		
Para modelos:	GM12, GM12+12, GM20+20, GM20+20-900, GM25+25-900, GM25-900, GM35, GM50-900		



1

código	107173	referencia	18100095
descripción	boquilla de quemador piloto SIT gas natural código 35 UE 1 pzs apto para serie 160 boquilla ø 0.35mm		
Para modelos:	GSDT12, GSDT20, GST12, GST20, GVM35, GVM35T, GW209T, GWD209T, GWDT12, GWDT20, GWT12, GWT20		



1

código	107175	referencia	00032690
descripción	boquilla de quemador piloto SIT gas natural código 51 UE 1 pzs apto para serie 160		
Para modelos:	GM12, GM12+12, GM20+20, GM20+20-900, GM25+25-900, GM25-900, GM35, GM50-900, GSDT12, GSDT20, GST12, GST20, GVM35, GVM35T, GW209T, GWD209T, GWDT12, GWDT20, GWT12, GWT20		

materiales auxiliares de gas

uniones roscadas

tornillos de racor



1

código	100906	referencia	33120004
descripción	unión roscada rosca M10x1 para electrodo de encendido latón UE 1 pzs EC 10		
Para modelos:	GSDT12, GSDT20, GST12, GST20, GVM35, GVM35T, GW209T, GWD209T, GWDT12, GWDT20, GWT12, GWT20		



1

código	100907	referencia	33120009
descripción	unión roscada rosca M10x1 UE 1 pzs tipo SEF 1 ømm para termopar		
Para modelos:	GSDT12, GSDT20, GST12, GST20, GVM35T, GW209T, GWD209T, GWDT12, GWDT20, GWT12, GWT20		

piezas angulares



1

código	104484	referencia	12355007
descripción	pieza angular G1: 1/2" M G2: 1/2" M		
Para modelos:	GSDT12, GSDT20, GST12, GST20, GVM35T, GW12ELT, GW209T, GW20ELT, GWD12ELT, GWD209T, GWD20ELT, GWDT12, GWDT20, GWT12, GWT20		

componentes específicos

para freidoras

tapa



1

código	695603	referencia	00030660
descripción	tapa apto para freidora L 305mm An 210mm con asidero		
Para modelos:	EB12+12, EB6, EB6+6		



1

código	695606	referencia	00030690
descripción	tapa apto para freidora L 340mm An 270mm		
Para modelos:	EB12, EB12+12, EB8, EM12, EM12+12, ES12, ESD12, FE12, FG12S, FG12M, FG24M, GB10, GBD10, GM12+12, GM2532, GMD2532, GST12, GW12, GW12ELT, GWD12, GWD12ELT, GWDT12, GWT12		

soportes cestas

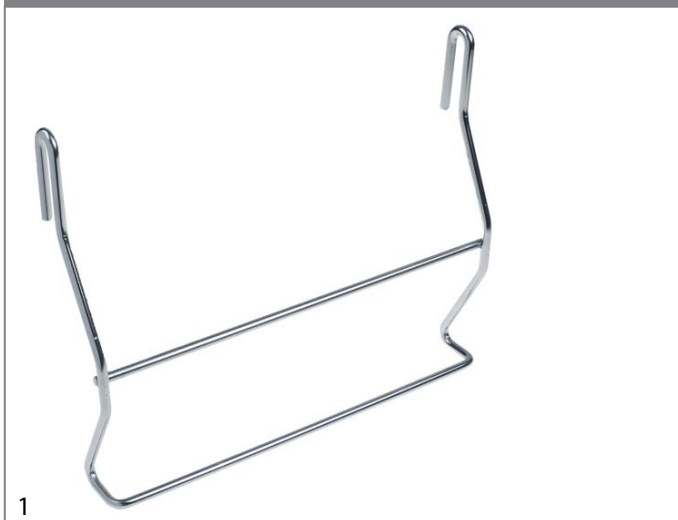

código	970736	referencia	00038567
descripción	soporte cesto para freidora An 265mm H 220mm para ELFRAMO GW		
Para modelos:	FG12M, FG24M, GB10, GBD10, GSDT12, GSDT20, GST12, GST20, GVM35, GVM35T, GW12ELT, GW209T, GW20ELT, GWD12, GWD20, GWD209T, GWDT12, GWDT20, GWT12, GWT20		

otros



código	550268	referencia	00032290
descripción	tapa para tecla		
Para modelos:	EB12, EB12+12, EB18P, EB6, EB6+6, EB8, EM12, EM12+12, EM20, EM20+20, EM20+20-900, EM20-900, EM35, EM40-900, ES12, ES20, ESD12, ESD20, FE12, FE20, FE20+20, FE30, FE30+30, KES20, KESD20		

para lavavajillas

componentes de salida/aspiración

ELFRAMO

cuerpo de salida/aspiración



código	511826	referencia	00012703
descripción	anillo de sujeción rosca 1 3/4" int.ø 44mm		
Para modelos:	B11, B15, BD11, BD13, BD14, BD14alt, BD22, BD46, BD47, BD50, BE35, BE40, BE50, BE50T, C33, C34, C34dgt, C44, C44dgt, C44dgt-elt, C66, C66dgt, C66dgt-elt, C77, CE24, CW650-15, CW650-16, CW650-35, CW650-36, D120, D120dgt, D30, D35, D36, D40, D40ELT, D40ELT-BT-BA, D40i, D40i-BT-BA, D40i-ELT-BT-BA, D45, D80, D80F, D85, ETE20, ETE21, ETE25, ETE27, LP60, LP60H...(Otros modelos se puede ver en la tienda web)		



código	511837	referencia	00012712
descripción	anillo de sujeción rosca 1 3/4" ø ext. 65mm		
Para modelos:	B11, BD11, BD13, BD14, BD46		



código	511827	referencia	00012704
descripción	brida ø ext. 115mm int.ø 55mm		
Para modelos:	B11, B15, BD11, BD13, BD14, BD46, BD47, BE35, BE40		



código	517804	referencia	00014169 00018351
descripción	codo de empalme rosca 1/2" tubo ø 13mm		
Para modelos:	BD50, BE35, BE40, BE50, BE50T, C34, C44, C44dgt, C66, C66dgt, C77, D120, D35, D36, D40i, D40i-BT-BA, D40i-ELT-BT-BA, D45, D85		





imagen no disponible

código	511851	referencia	00012728
descripción	cuerpo de aspiración completo		
Para modelos:	D80		



código	511846 ¹	referencia	00018303
descripción	cuerpo de aspiración completo rosca 1 3/4"		
Para modelos:	C44, C66, D120, ETE20, ETE21, ETE25, ETE27, LP60, LP60H, LP61, LP61H		

¹para bomba de desagüe



código	511092	referencia	00002110
descripción	cuerpo de aspiración ø ext. 125mm H 100mm int.ø 62mm tubo ø 70mm		





código	511079	referencia	00202120
descripción	cuerpo de aspiración/salida		
Para modelos:	42, 42E, 48, 48E, 55, 55E, 60		



código	511094	referencia	00002100 00011120
descripción	cuerpo de aspiración/salida		
Para modelos:	882, 885, SQ885, SQT80		



código	511096	referencia	00011130
descripción	cuerpo de aspiración/salida		
Para modelos:	120, 160, 240, 906, 908, C44, C66		
accesorios para	511096		
	código	511463	referencia 00003600
	empalme de tubo rosca 1¼" ø 28mm		



código	511843	referencia	00012701
descripción	empalme de desagüe		
Para modelos:	BD14, BD14alt, BD47, C33, C34, C34dgt, C44, C44dgt, C44dgt-elt, C66, C66dgt, C66dgt-elt, C77, CE24, CW650-15, CW650-16, CW650-35, CW650-36, D120, D120dgt, D30, D40, D80, D80F, D85, ETE20, ETE21, ETE25, ETE27, LP60, LP60H, LP61, LP61H		



código	511830	referencia	00211035
descripción	empalme de desagüe rosca 1¼" tubo ø 28.5mm		
Para modelos:	B11, B15, BD11, BD13, BD14, BD22, BD47, BD50, BE35, BE40, BE50, BE50T, C44, C66, C77, D30, D35, D36, D40, D40ELT, D40ELT-BT-BA, D40i, D40i-BT-BA, D40i-ELT-BT-BA, D45		



código	511838 ¹	referencia	00211026
descripción	empalme de desagüe rosca 1¼" tubo ø 28mm		
Para modelos:	B11, BD11, BD13, BD14, BD46, BD50, BE35, BE40, BE50, C34, C34dgt, C44dgt, C44dgt-elt, C66dgt, C66dgt-elt, D85, LP61, LP61H		

¹para bomba de desagüe



código	511085	referencia	00002103
descripción	junta para ELFRAMO núm. Ref. 00002103 salida		
Para modelos:	120, 160, 240, 882, 885, 906, 908, C44, C66, SQ885, SQT80		



código	511828	referencia	06140018
descripción	junta tórica EPDM espesor 3.53mm int.ø 56.74mm UE 1 pzs		
Para modelos:	B11, B15, BD11, BD13, BD14, BD14alt, BD22, BD46, BD47, BD50, BE35, BE40, BE50, BE50T, C33, C34, C34dgt, C44, C44dgt, C44dgt-elt, C66, C66dgt, C66dgt-elt, C77, CE24, CW650-15, CW650-16, CW650-35, CW650-36, D120, D120dgt, D30, D35, D36, D40, D40ELT, D40ELT-BT-BA, D40i, D40i-BT-BA, D40i-ELT-BT-BA, D45, D80, D80F, D85, ETE20, ETE21, ETE25, ETE27, ETS15, LP60...(Otros modelos se puede ver en la tienda web)		



código	511853	referencia	00012702
descripción	pileta de desagüe		
Para modelos:	BD22, C33, C44, C66, CW650-15, CW650-16, CW650-35, CW650-36, D120, D120dgt, D30, D35, D36, D40, D40ELT, D40ELT-BT-BA, D40i, D40i-BT-BA, D40i-ELT-BT-BA, D45, D80, D80F, D85, ETE20, ETE21, ETE25, ETE27		



código	511070	referencia	00002130
descripción	pileta de desagüe completo		
Para modelos:	ET, ET020, ETA, ETE20, ETE21, ETE25, ETE27		



código	511836	referencia	00012715
descripción	pileta de desagüe completo rosca 1¼" ø ext. 65mm int.ø 43mm tubo ø 37mm		
Para modelos:	C44, C66, D30, D80, LP60		



 <p>1</p>			
código	512409	referencia	00012703+00211035+06140018 00012741
descripción	pileta de desagüe completo rosca 1 3/4" ø ext. 70.5mm int.ø 52mm tubo ø 28.5mm		
repuestos para	512409		
	código	511826	referencia 00012703
	anillo de sujeción rosca 1 3/4" int.ø 44mm		
	código	511828	referencia 06140018
	junta tórica EPDM espesor 3.53mm int.ø 56.74mm UE 1 pzs		
	código	511830	referencia 00211035
	empalme de desagüe rosca 1 3/4" tubo ø 28.5mm		

 <p>imagen no disponible</p> <p>1</p>			
código	511835	referencia	00211036
descripción	unidad de desagüe completo		
Para modelos:	B11, B15		

<p>filtros</p>  <p>1</p>			
código	507384	referencia	00071600 00085810
descripción	filtro		
Para modelos:	EN, ET, ET020, ETA, LP130, LP70, LPE100, LPE145		

 <p>1</p>			
código	511847	referencia	00222030
descripción	filtro aspiración aspiración ø 205mm		
Para modelos:	BD14, BD14alt		

 <p>1</p>			
código	517492	referencia	00065288
descripción	filtro aspiración H 142mm inox L 130mm An 93mm		
Para modelos:	LP130, LP70		

 <p>1</p>			
código	511850	referencia	00012735
descripción	filtro aspiración ø 225mm		
Para modelos:	C33, CW650-15, CW650-16, CW650-35, CW650-36, D40, D40ELT, D40ELT-BT-BA, D40i, D40i-ELT-BT-BA, D80		

 <p>1</p>			
código	511120	referencia	00011020
descripción	filtro plano		
Para modelos:	120, 160, 904, 906, 908, 912		

 <p>1</p>			
código	511121	referencia	00011230
descripción	filtro plano		
Para modelos:	120, 160, 240, 904, 906, 908, 912, D120, D36, D45, D80, D80F, D85		

 <p>1</p>			
código	511122	referencia	00010930
descripción	filtro plano		
Para modelos:	120, 160		

 <p>1</p>			
código	511852	referencia	00010580
descripción	filtro plano		
Para modelos:	882, 885, 904, 906, 908, 912		



1

código	511590	referencia	00065523 00067144
descripción	filtro plano H 15mm acero inoxidable L 318mm An 242mm		
Para modelos:	D120, D120dgt, LP60, LP60H, LP61, LP61H, LP70		



1

código	517491	referencia	00065750
descripción	filtro plano H 27mm inox L 365mm An 270mm		
Para modelos:	LP130		



1

código	517493	referencia	00079360
descripción	filtro plano H 35mm inox L 577mm An 225mm		
Para modelos:	ETE20, ETE21, ETE25, ETE27		



1

código	511583	referencia	00018042
descripción	filtro plano L 257mm An 294mm		
Para modelos:	C44, C44dgt, C44dgt-elt, C66, C66dgt, C66dgt-elt, C77		



1

código	511087	referencia	00002010
descripción	filtro redondo aspiración		



1

código	511091	referencia	00002070
descripción	filtro redondo aspiración		



1

código	511825	referencia	00200500
descripción	filtro redondo ø 115mm H 55mm		
Para modelos:	42, 42E, 48, 48E, 55, 55E, B11, B15, BD11, BD13, BD14, BD46, BD47, BE35, BE40		



1

código	511849	referencia	00013773
descripción	filtro redondo ø 145mm H 107mm		
Para modelos:	D30, D35, D36, D40, D40ELT, D40ELT-BT-BA, D40i, D40i-BT-BA, D40i-ELT-BT-BA, D45, D80		



1

código	511845	referencia	00018301
descripción	filtro redondo ø 145mm H 150mm		
Para modelos:	C33, C34, C34dgt, C44, C44dgt, C44dgt-elt, C66, C66dgt, C66dgt-elt, CE24, CW650-15, CW650-16, CW650-35, CW650-36, D80, D80F, D85		



1

código	511089	referencia	00002060
descripción	filtro redondo ø 160mm		
Para modelos:	120, 160, 240, 885, 906, 908, C44, C66		





1

código	517485	referencia	00222665
descripción	filtro redondo ø 167mm H 112mm		
Para modelos:	BD50, BE50, BE50T		





			
1			
código	517484	referencia	00065570
descripción	filtro redondo ø 235mm H 180mm agujero ø 56mm		
Para modelos:	C77, D120, D120dgt, LP60, LP60H, LP61, LP61H		

			
1			
código	511848	referencia	00012724
descripción	filtro redondo ø 81mm H 67mm		
Para modelos:	B11, BD11, BD13, BD14, BD46		

			
1			
código	511090	referencia	00002000
descripción	filtro redondo salida		

tubos de rebose			
			
1			
código	511093	referencia	00002113 0000211C
descripción	junta con 4 orificios roscados int.ø 74mm ø ext. 116mm espesor 3mm		

			
1			
código	511834	referencia	06160041
descripción	junta ø 33mm		
Para modelos:	B11, B15, BD11, BD13, BD14, BD14alt, BD22, BD50, BE35, BE40, BE50, BE50T, C33, C34, C34dgt, C44, C44dgt, C44dgt-elt, C66, C66dgt, C66dgt-elt, C77, CW650-15, CW650-16, CW650-35, CW650-36, D120, D120dgt, D30, D35, D36, D40, D40ELT, D40ELT-BT-BA, D40i, D40i-BT-BA, D40i-ELT-BT-BA, D45, D80, D80F, D85, EN, ET, ET020, ETA, ETE20, ETE21, ETE25, ETE27, ETS15...(Otros modelos se puede ver en la tienda web)		

			
1			
código	511209	referencia	06160004
descripción	junta ø ext. 32mm int.ø 22mm espesor 5.5mm UE 1 pzs		
Para modelos:	120, 160, 240, 42, 42E, 48, 48E, 55, 55E, 60, 882, 885, 906, 908, SQ885, SQT80		

			
1			
código	503186	referencia	00211052
descripción	tubo de rebose L 130mm ø 43mm		
Para modelos:	B11, BD11, BD13, BD14, BD46, BE35, BE40		

			
1			
código	511831	referencia	00210937
descripción	tubo de rebose L 140mm ø 43mm		
Para modelos:	B11, B15, BD11, BD13, BD14, BD46, BE35, BE40		
repuestos para	511831		
	código	511834	referencia
			06160041
	 junta ø 33mm		

			
1			
código	511833 ¹	referencia	00222045
descripción	tubo de rebose L 180mm ø 43mm		
Para modelos:	BD14, BD14alt, BD47		

¹para bomba de desagüe

			
1			
código	511832	referencia	00222035
descripción	tubo de rebose L 185mm ø 43mm		
Para modelos:	BD14, BD14alt, BD47		



1

código	511840 ¹	referencia	00013839
descripción	tubo de rebose L 190mm ø 43mm		
Para modelos:	BD22, D30, D35, D36, D40, D40ELT, D40ELT-BT-BA, D40i, D40i-BT-BA, D40i-ELT-BT-BA, D45		
accesorios para	511840		
	código	referencia	06160041
	junta ø 33mm		

para bomba de desagüe



1

código	511839	referencia	00012718
descripción	tubo de rebose L 195mm ø 43mm		
Para modelos:	BD22, D30, D35, D36, D40, D40ELT, D40ELT-BT-BA, D40i, D40i-BT-BA, D40i-ELT-BT-BA, D45		
accesorios para	511839		
	código	referencia	06160041
	junta ø 33mm		



1

código	511841	referencia	00013994
descripción	tubo de rebose L 225mm ø 43mm		
Para modelos:	D80		



1

código	511842	referencia	00013997
descripción	tubo de rebose L 225mm ø 43mm		
Para modelos:	D80		



1

código	511059	referencia	00202132
descripción	tubo de rebose L 230mm ø 37mm		
Para modelos:	42, 42E, 48, 48E, 55, 55E, 60		



1

código	511061	referencia	00001950
descripción	tubo de rebose L 230mm ø 37mm		



1

código	511062	referencia	00001960
descripción	tubo de rebose L 230mm ø 37mm		



1

código	511063	referencia	00013110
descripción	tubo de rebose L 230mm ø 37mm		
Para modelos:	882, 885, SQ885, SQT80		



1

código	511060	referencia	00202136
descripción	tubo de rebose L 230mm ø 37mm para bomba de desagüe		
Para modelos:	42, 42E, 48, 48E, 55, 55E, 60		



1



código	511064	referencia	00013115
descripción	tubo de rebose L 230mm ø 37mm para bomba de desagüe		
Para modelos:	120, 882, 885		

1



código	517489	referencia	00065554
descripción	tubo de rebose L 350mm ø 43mm		
Para modelos:	C44, C66, C77, D120, D120dgt, LP60, LP60H, LP61, LP61H		

1



código	511387	referencia	00014074
descripción	tubo de rebose L 240mm ø 43mm		
Para modelos:	BD50, BE50, BE50T, C33, CW650-15, CW650-16, CW650-35, CW650-36, D80, D80F, D85		
repuestos para	511387		
	código	511834	referencia 06160041
	junta ø 33mm		

1



código	518625	referencia	00065375
descripción	tubo de rebose L 390mm ø 38mm		
Para modelos:	LP130, LP70		

1



código	511065	referencia	00013100
descripción	tubo de rebose ø 37mm		
Para modelos:	120, 160, 240, 906, 908		

1



código	517499	referencia	00222670
descripción	tubo de rebose L 240mm ø 43mm		
Para modelos:	BD50, BE50, BE50T		

1



código	511066	referencia	00013105
descripción	tubo de rebose ø 37mm		
Para modelos:	120, 906, 908		

1



código	511844	referencia	00018271
descripción	tubo de rebose L 315mm ø 43mm		
Para modelos:	C34, C34dgt, C44, C44dgt, C44dgt-elt, C66, C66dgt, C66dgt-elt, CE24		
repuestos para	511844		
	código	511834	referencia 06160041
	junta ø 33mm		

contenedores

recipientes de dosificación

1



código	511162	referencia	00003730
descripción	cajón para abrillantador		
accesorios para	511162		
	código	511163	referencia 00003731 373A
	tornillo para recipient abrillantador		



1

código	361739	referencia	00003740
descripción	recipiente abrillantador		



1

código	511126	referencia	00011060
descripción	recipiente abrillantador		
Para modelos:	120, 160, 240, 882, 885, 904, 906, 908, 912		

recipientes de sal



1

código	511895	referencia	12145002
descripción	recipiente de sal		
Para modelos:	42, 42E, 48, 48E, 55, 60		

accesorios



1

código	511487	referencia	00011053
descripción	tolva de llenado		
Para modelos:	42, 42E, 48, 48E, 55, 55E, 60		



1

código	511163	referencia	00003731 373A
descripción	tornillo para recipient abrillantador		
Para modelos:	ES400, ES400-alt, ES400-sehr-alt, MRS400, MRS400-alt		

calentadores de agua
calentadores de agua para lavavajillas



1

código	511899	referencia	00013771
descripción	calentador de agua		
Para modelos:	CE24, D30, D80		



1

código	511901	referencia	00003440
descripción	calentador de agua		



1

código	511896	referencia	00211009
descripción	calentador de agua ø 120mm L 270mm		
Para modelos:	B11, B15, BD11, BE35, BE40		

			
1			
código	511898	referencia	00210410
descripción	calentador de agua ø 140mm L 270mm		
Para modelos:	42, 42E, 48, 48E, 55, 55E, 60		

			
1			
código	511897	referencia	00222040
descripción	calentador de agua ø 140mm L 270mm brida 4 orificios entrada ø 50		
Para modelos:	BD13, BD14, BD14alt, BD22, BD46, BD47, BD50, BE50, BE50T		

			
1			
código	511900	referencia	00010500 00065312
descripción	calentador de agua ø 170mm L 440mm		
Para modelos:	120, 160, 240, 882, 885, 904, 906, 908, 912, C33, C34, C34dgt, C44, C44dgt, C44dgt-elt, C66, C66dgt, C66dgt-elt, C77, CE24, CW650-15, CW650-16, CW650-35, CW650-36, D120, D120dgt, D30, D35, D36, D40, D40ELT, D40ELT-BT-BA, D40i, D40i-ELT-BT-BA, D45, D80, D80F, D85, LP60, LP60H, LP61, LP61H, LP70		

accesorios			
			
1			
código	699274	referencia	00010514
descripción	pieza de empalme para calentador de agua rosca 1/2" L 75mm An 32mm tubo ø 14/5mm		
Para modelos:	BD46, BD47, BE35, BE40, BE50, BE50T, C34, C44dgt, C44dgt-elt, C66dgt, C66dgt-elt, CE24, D120dgt, D36, D45, D85, LP61, LP61H, LP70		

			
1			
código	511817	referencia	00010502
descripción	pieza T empalme 1/4" M - 1/2" H tubo ø 13mm 1/4" M - 1/2" H tubo ø 13mm		
Para modelos:	120, 160, 240, 882, 885, 904, 906, 908, 912, B11, B15, BD11, BD13, BD14, BD14alt, BD22, BD46, BD47, BD50, BE35, BE40, BE50, C33, C34, C34dgt, C44, C44dgt, C66, C66dgt, C77, D120, D30, D35, D36, D40, D40ELT, D40ELT-BT-BA, D40i, D40i-ELT-BT-BA, D45, D80, D80F, D85, LP60, LP60H, LP61, LP61H, SQ885, SQT80		

platos giratorios			
aros giratorios			
			
1			
código	519419	referencia	00005491
descripción	árbol por plato giratorio ø 47mm		
Para modelos:	120, 160, 240, 882, 885, 908		

cartuchos descalcificadores			
columnas descalcificadoras			
			
1			
código	530000	referencia	12145001
descripción	descalcificador cuádruple L 380mm An 180mm		

			
1			
código	530001	referencia	12145001
descripción	descalcificador cuádruple L 380mm An 180mm		
Para modelos:	42, 42E, 48, 48E, 55, 55E, 60, B11, BD11, BD13, BD14, BD14alt, BD22, BD50, BE35, BE40, BE50, BE50T, D35, D36, D40, D40ELT, D40ELT-BT-BA, D40i, D40i-BT-BA, D40i-ELT-BT-BA, D45		

cajas y paneles frontales			
paneles			
			
1			
código	403262	referencia	00222433
descripción	panel de mando sistemas de lavado BE35 An 178mm H 48mm P 58mm para ELFRAMO		
Para modelos:	BD50, BE35, BE40, BE50		

otros



1

código	692476	referencia	00222460
descripción	distanciador para tapa L 43mm int.ø 5mm ø ext. 24.6mm espesor 2.7mm		
Para modelos:	BD50, BE35, BE40, BE50		

mecanismos de capota para lavavajillas

pernos



1

código	511888	referencia	00018051
descripción	perno roscado mecanismo de campana		
Para modelos:	C33, C34, C34dgt, C44, C44dgt, C44dgt-elt, C66, C66dgt, C66dgt-elt, C77, CE24, CW650-15, CW650-16, CW650-35, CW650-36		

muelles



1

código	511623	referencia	00002320
descripción	resorte para mecanismos de capota		



1

código	511625	referencia	00002330
descripción	resorte para mecanismos de capota		

manillas de capota



1

código	701464	referencia	00018661
descripción	manilla de camapana L 870mm An 705mm		
Para modelos:	C34, C34dgt, C44dgt, C44dgt-elt, C66dgt, C66dgt-elt, CE24		

soportes para manillas de capota



1

código	511560	referencia	00018030 00018049 00018165
descripción	soporte de asidero mecanismo de campana H 42mm ø 90mm		
Para modelos:	C33, C34, C34dgt, C44, C44dgt, C44dgt-elt, C66, C66dgt, C66dgt-elt, C77, CE24, CW650-15, CW650-16, CW650-35, CW650-36		

ruedas de rodadura



1

código	511595	referencia	00065842
descripción	juego de ruedas de rodadura ø 30mm H 24mm para lavavajillas agujero ø 15mm		
Para modelos:	LP130		



1

código	511876	referencia	00013784
descripción	rueda de rodadura ø ext. 40mm int.ø 11mm		
Para modelos:	BD14, BD14alt, BD22, BD46, BD47, D36, D40, D40ELT, D40ELT-BT-BA, D40i, D40i-BT-BA, D40i-ELT-BT-BA, D45, D80, D80F, D85		

cables de mando



1

código	511118	referencia	00000235 00002350
descripción	cable de mando pedal para capota		



1

código	511152	referencia	00002370
descripción	cable de tracción L 900mm mecanismo de campana		

otros



1

código	511887	referencia	00018050
descripción	casquillo mecanismo de campana		
Para modelos:	C33, C34, C34dgt, C44, C44dgt, C44dgt-elt, C66, C66dgt, C66dgt-elt, C77, CE24, CW650-15, CW650-16, CW650-35, CW650-36		



1

código	511886	referencia	00018021
descripción	rueda de rodadura mecanismo de campana		
Para modelos:	C33, C34, C34dgt, C44, C44dgt, C44dgt-elt, C66, C66dgt, C66dgt-elt, C77, CE24, CW650-15, CW650-16, CW650-35, CW650-36, GFP25, GFP25AC, GFU25, GFU25AC		



1

código	511885	referencia	00018026
descripción	soporte de asidero mecanismo de campana		
Para modelos:	C33, C34, C34dgt, C44, C44dgt, C44dgt-elt, C66, C66dgt, C66dgt-elt, C77, CE24, CW650-15, CW650-16, CW650-35, CW650-36		

guías para cestos

barras guía



1

código	699273	referencia	00073240
descripción	guía L 50mm An 45mm H 80mm con ruedas		
Para modelos:	ET, ET020, ETA, ETE20, ETE21, ETE25, ETE27		

soportes para cestos



1

código	971059	referencia	00018060 00018404
descripción	soporte para cestos L 640m An 560mm H 110mm		
Para modelos:	C34, C34dgt, C44, C44dgt, C44dgt-elt, C66, C66dgt, C66dgt-elt, CE24		

cámaras de aire

cámaras de aire



1

código	511067	referencia	00002180 00011350 00205750
descripción	cámara de aire		
Para modelos:	120, 160, 240, 904, 906, 908, 912, C34, C34dgt, C44, C44dgt, C44dgt-elt, C66, C66dgt, C66dgt-elt, C77, D120, D120dgt, EN, ET, ET020, ETA, ETE20, ETE21, ETE25, ETE27, ETS15, LP130, LP60, LP60H, LP61, LP61H, LP70, LPE100, LPE145		



1

código	511069	referencia	00205750
descripción	cámara de aire		
Para modelos:	42, 42E, 48, 48E, 55, 55E, 60, B11, B15		



1

código	511820	referencia	00012716
descripción	cámara de aire		
Para modelos:	BD14alt, D30, D40		



1

código	511821	referencia	00013984
descripción	cámara de aire		



1

código	511824	referencia	00013984 00014098 00014099
descripción	cámara de aire		
Para modelos:	B11, BD11, BD13, BD14, BD22, BD46, BD47, BE35, BE40, D30, D35, D36, D40, D40i, D40i-BT-BA, D45, D80		



1

código	519465	referencia	00014086 00014087
descripción	cámara de aire ø 45mm H 160mm rosca 3/8" tubo ø 6mm		
Para modelos:	C33, D80, D80F, D85		

accesorios para cámaras de aire



1

código	511823	referencia	00012719
descripción	empalme de tubo		
Para modelos:	BD14alt, D30, D40		

mecánicas para lavavajillas de cinta transportadora



1

código	532687	referencia	00049050
descripción	dedo de transporte L 115mm An 68mm agujero ø 8.5mm		

bloqueos antirretorno

bloqueos antirretorno



1

código	504140	referencia	23180203
descripción	bloqueo antirretorno		



1

código	511124	referencia	23180200 23180202
descripción	bloqueo antirretorno lavavajillas		
Para modelos:	120, 160, 240, 42, 42E, 48, 48E, 55, 55E, 60, 882, 885, 904, 906, 908, 912, B11, B15, BD14alt, C33, C44, C66, D120, D30, D40, D80, LP130, LP60, LP70		



1

código	516101	referencia	23180203	
descripción	bloqueo antirretorno lavavajillas tubo ø 12mm			
Para modelos:	B11, BD13, BD14, BD46, BD47, BD50, BE35, BE40, BE50, BE50T, C33, C34, C34dgt, C44, C44dgt, C44dgt-elt, C66, C66dgt, C66dgt-elt, C77, CE24, D120, D120dgt, D30, D35, D36, D40, D40ELT, D40ELT-BT-BA, D40i, D40i-BT-BA, D40i-ELT-BT-BA, D45, D80, D85, LP130, LP60, LP60H, LP61, LP61H, LP70			
repuestos para	516101			
	código	506367	referencia	—
	junta plana goma ø ext. 40mm int.ø 28mm espesor 1.8mm UE 1 pzs			

macánica de puertas

muelles

resortes enrollados



1	código	519550	referencia	00079740
	descripción	resorte enrollado An 25.35mm		
	Para modelos:	ETE20, ETE21, ETE25, ETE27		



1	código	519491	referencia	00079730
	descripción	resorte enrollado An 26mm		
	Para modelos:	ETE20, ETE21, ETE25, ETE27, ETS15, LP130, LP60H, LP61H, LP70		



1	código	519543	referencia	00065816
	descripción	resorte enrollado con soporte An 46mm int.ømm longitud de lengüeta mm		
	Para modelos:	LP130, LP60, LP60H, LP61, LP61H		

varillaje



1	código	511872	referencia	00210940
	descripción	barra de tracción		
	Para modelos:	B15, BD11, BD13, BD14, BD14alt, BD22, D120, D30, D40, D80, D80F		

1			
código	511884	referencia	00001710
descripción	barra de tracción completo		
Para modelos:	120, 160, 885, 904, 906, 908, 912, SQ885, SQT80		

1			
código	511871	referencia	00210983
descripción	barra de tracción L 260mm		
Para modelos:	B11, BD13, BD14, BD22, BD50, BE50, BE50T, D120, D120dgt, D30, D35, D36, D40, D40ELT, D40ELT-BT-BA, D40i, D40i-BT-BA, D40i-ELT-BT-BA, D45, D80, D85		

1			
código	511880	referencia	00210361
descripción	barra de tracción pos. de montaje derecho completo		
Para modelos:	42, 42E, 48, 48E, 55, 55E		

1			
código	511882	referencia	00010720
descripción	barra de tracción pos. de montaje derecho completo		
Para modelos:	120, 160, 240, 42, 42E, 48, 48E, 55, 55E, 60, 882, 885		

1			
	imagen no disponible		
código	511883	referencia	00010730
descripción	barra de tracción pos. de montaje izquierdo completo		
Para modelos:	120, 160, 240, 42, 42E, 48, 48E, 55, 55E, 60, 882, 885		

1			
código	698783	referencia	00073630
descripción	tirante de puerta		
Para modelos:	ET, ET020, ETA		

1			
código	511906	referencia	00210993
descripción	tirante de puerta L 210mm barra de tracción		
Para modelos:	B11		



1

código	698784	referencia	00073640
descripción	tirante de puerta pos. de montaje arriba		
Para modelos:	ET, ET020, ETA		



1

código	511881	referencia	00210366
descripción	tirante de puerta pos. de montaje izquierdo completo barra de tracción		
Para modelos:	42, 42E, 48, 48E, 55, 55E		

pernos roscados



1

código	511879	referencia	00210939
descripción	pieza roscada pieza roscada		
Para modelos:	B11, B15, BD11, BD13, BD14, BD14alt, BD22, BD50, BE50, BE50T, D120, D120dgt, D30, D35, D36, D40, D40ELT, D40ELT-BT-BA, D40i, D40i-BT-BA, D40i-ELT-BT-BA, D45, D80, D80F, D85		

placas de fricción



1

código	511907	referencia	00013777
descripción	placa de fricción		
Para modelos:	BD14, BD14alt, D120, D120dgt, D30, D40, D80		



1

código	511878	referencia	00013780
descripción	placa de fricción placa de fricción		
Para modelos:	BD14, BD14alt, D30, D40, D80		

rollos



1

código	501445	referencia	00041907
descripción	rollo ø ext. 23.7mm para puerta alojamiento del eje 8mm		
Para modelos:	EN, ET, ET020, ETA, LPE100, LPE145		



1

código	501431	referencia	00013907
descripción	rollo ø ext. 9mm para mecánica de puertas alojamiento del eje 3.5mm An 5mm		
Para modelos:	BD14, BD14alt, BD22, BD46, BD47, D35, D36, D40, D40ELT, D40ELT-BT-BA, D40i, D40i-BT-BA, D40i-ELT-BT-BA, D45, D80, D80F, D85, ET, ETE20, ETE21, ETE25, ETE27, ETS15		

bisagras



1

código	517780	referencia	00222626
descripción	bisagra para puerta pos. de montaje derecho para lavavajillas L 130mm H 32mm		
Para modelos:	BD50, BE35, BE40, BE50, BE50T		



1

código	517781	referencia	00222629
descripción	bisagra para puerta pos. de montaje izquierdo lavavajillas L 130mm ELFRAMO An 32mm		
Para modelos:	BD50, BE35, BE40, BE50, BE50T		



1

código	519417	referencia	00065309
descripción	bisagra de puerta		
Para modelos:	D120, LP130, LP60, LP60H, LP61, LP61H, LP70		



1

código	511865	referencia	00210903
descripción	bisagra de puerta bisagra derecha pos. de montaje derecho		
Para modelos:	B11, B15		



1

código	511873	referencia	00013743
descripción	bisagra de puerta bisagra derecha pos. de montaje derecho		
Para modelos:	BD14, BD14alt, BD22, D36, D40, D40ELT, D40ELT-BT-BA, D40i, D40i-BT-BA, D40i-ELT-BT-BA, D45, D80, D80F, D85		



1

código	511866	referencia	00210902
descripción	bisagra de puerta bisagra izquierda pos. de montaje izquierdo		
Para modelos:	B11, B15		



1

código	511874	referencia	00013744
descripción	bisagra de puerta bisagra izquierda pos. de montaje izquierdo		
Para modelos:	BD14, BD14alt, BD22, D36, D40, D40ELT, D40ELT-BT-BA, D40i, D40i-BT-BA, D40i-ELT-BT-BA, D45, D80, D80F, D85		



1

código	504647	referencia	00002509
descripción	bisagra de puerta palanca bisagra izquierda pos. de montaje izquierdo		

guías de puertas



1

código	517496	referencia	00065245
descripción	guía de puerta L 460mm An 34mm H 25mm pos. de montaje izquierdo/derecho		
Para modelos:	LP130, LP60, LP60H, LP61, LP70		

imanes de puerta



1

código	694539	referencia	25110108
descripción	imán de puerta L 63mm An 7.5mm H 19mm distancia de sujeción 52mm		
Para modelos:	D120dgt		

topes de puerta



1

código	511869	referencia	00013791
descripción	tope de puerta mecanismo de cierre		
Para modelos:	B11, B15, BD14, BD14alt, D120, D30, D40, D80		

cierres



1

código	511104	referencia	00001630 00001640
descripción	cierre de puerta		
accesorios para	511104		
	código	511105	referencia 00001670 00001680
contrapieza cierre de puerta			



1

código	511082	referencia	00011028
descripción	cierre de puerta completo cierre		
Para modelos:	120, 160, 240, 42, 42E, 48, 48E, 55, 55E, 60, 882, 885, 904, 906, 908, 912, B11, B15, BD11, BD13, D120, D120dgt, D30, D35, SQ885, SQT80		
accesorios para	511082		
	código	511083	referencia 00011040
contrapieza cierre de puerta			



1

código	511083	referencia	00011040
descripción	contrapieza cierre de puerta		
Para modelos:	120, 160, 240, 42, 42E, 48, 48E, 55, 55E, 60, 882, 885, 904, 906, 908, 912, B11, B15, BD11, BD13, D120, D120dgt, D30, D35, SQ885, SQT80		



1

código	511105	referencia	00001670 00001680
descripción	contrapieza cierre de puerta		

otros



1

código	511868	referencia	00013829
descripción	bisagra completo bisagra		
Para modelos:	D120, D120dgt, D30		



1

código	511594	referencia	00220340
descripción	bisagra para puerta lavavajilla juego D1 ø 20mm D2 ø 12mm		
Para modelos:	B11, BD11, BD13, BD22, D30, D35		



1

código	511877	referencia	00222059
descripción	cable de tracción cable de tracción		
Para modelos:	BD14, BD14alt, D80, D85		



1

código	524047	referencia	00013786
descripción	cable de tracción para mecánica de puertas ø 1.5mm L 475mm		
Para modelos:	BD22, BD46, BD47, D36, D40, D40ELT, D40ELT-BT-BA, D40i, D40i-BT-BA, D40i-ELT-BT-BA, D45, D80, D80F		



1

código	504648	referencia	00013152
descripción	casquillo casquillo		





1

código	519408	referencia	00013909
descripción	guía de varillaje para barra de tracción completo		
Para modelos:	B11, BD11, BD13, BD14, BD22, BD50, BE50, BE50T, D120, D120dgt, D30, D35, D36, D40, D40ELT, D40ELT-BT-BA, D40i, D40i-BT-BA, D40i-ELT-BT-BA, D45, D80, D80F, D85		



1

código	517782	referencia	00001672
descripción	resorte L 16.5mm pos. de montaje guía de puerta D1 ø 9mm espesor de hilo 1.2mm		
Para modelos:	BD50, BE35, BE40, BE50		



1

código	530847	referencia	00065595
descripción	tapa para tirador de puerta int.ø 5mm D1 ø 21.7mm D2 ø 12.7mm		
Para modelos:	ETE20, ETE21, ETE25, ETE27, LP130, LP60, LP60H, LP61, LP61H, LP70		

uniones roscadas



1

código	519409	referencia	00013785
descripción	tornillo		
Para modelos:	BD14, BD14alt, BD22, BD46, BD47, D36, D40, D40ELT, D40ELT-BT-BA, D40i, D40i-BT-BA, D40i-ELT-BT-BA, D45, D80, D80F, D85		

cortinas



1

código	533013	referencia	00076010
descripción	cortina An 620mm H 550mm sistemas de lavado		
Para modelos:	EN, ET, ET020, ETA, ETE20, ETE21, ETE25, ETE27, ETS15		



1

código	533021	referencia	00062000 00062030
descripción	cortina An 650mm H 450mm plástico espesor 1.5mm		
Para modelos:	EN, ET, ET020, ETA, ETE20, ETE21, ETE25, ETE27, ETS15		

sistemas de lavado y aclarado



1

código	511716	referencia	00222102
descripción	null		
Para modelos:	BD14, BD14alt, BD47, C33, CW650-15, CW650-16, CW650-35, CW650-36, D80, D85		





1

código	511713	referencia	00222111
descripción	cojinete de brazo de lavado		
Para modelos:	BD13, BD14, BD14alt, BD22, BD46, BD47, BE40		

		
1		
código	511729	referencia 00014041
descripción	cojinete de brazo de lavado	
Para modelos:	BD50, BE50, BE50T, C33, C34, C34dgt, CE24, CW650-15, CW650-16, CW650-35, CW650-36, D30, D35, D36, D40, D40ELT, D40ELT-BT-BA, D40i, D40i-BT-BA, D40i-ELT-BT-BA, D45, D80, D80F, D85	

		
1		
código	511728	referencia 00018077
descripción	tubo de aclarado	
Para modelos:	C44, C44dgt, C44dgt-elt, C66, C66dgt, C66dgt-elt, C77, D120, D120dgt, D30, D40	

		
1		
código	511730	referencia 00014042
descripción	tubo de aclarado	
Para modelos:	BD50, BE50, BE50T, C33, C34, C34dgt, CE24, CW650-15, CW650-16, CW650-35, CW650-36, D30, D35, D36, D40, D40ELT, D40ELT-BT-BA, D40i, D40i-BT-BA, D40i-ELT-BT-BA, D45, D80, D80F, D85	

		
1		
código	511732	referencia 00013779
descripción	tubo de aclarado	
Para modelos:	D30, D35, D40, D40ELT, D40ELT-BT-BA, D40i, D40i-BT-BA, D40i-ELT-BT-BA	

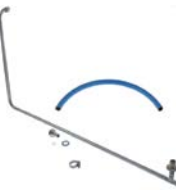
		
1		
código	517503	referencia 00018038 00018261 00018352
descripción	tubo de aclarado L 770mm	
Para modelos:	C34, C34dgt, C44, C44dgt, C44dgt-elt, C66, C66dgt, C66dgt-elt, C77, D120, D120dgt	

		
1		
código	511624	referencia 00005080
descripción	tubo de aclarado ø 10mm L 400mm empalme 3/8"	
Para modelos:	120, 240, C44, C66, C77, D120, D120dgt, LP130, LP60, LP60H, LP61, LP61H, LP70	

		
1		
código	511720	referencia 00211015
descripción	tubo de aclarado pos. de montaje abajo	
Para modelos:	B11, B15, BD11, BD13, BD14, BD22, BD46, BE35, BE40	

		
1		
código	511741	referencia 02120040
descripción	disco de reducción	
Para modelos:	C34, C34dgt, C44, C66, CE24, LP130, LP60, LP60H, LP61, LP61H, LP70	

		
1		
código	511484	referencia 00000395 00003950
descripción	pieza T rosca 1¼" H 82mm L 120mm	
Para modelos:	SQ885, SQT80	

		
1		
código	511781	referencia 00202632
descripción	soporte de brazo de aclarado pos. de montaje arriba	
Para modelos:	42, 42E, 48, 48E, 55, 55E, 60, B11, B15, BD11, BE35	

		
1		
código	511704	referencia 00018076
descripción	tornillo de cabeza moleteada	
Para modelos:	B11, B15, BD11, BD13, BD14, BD14alt, BD22, BD46, BD47, BE35, BE40, BE50, C33, C34, C34dgt, C44, C44dgt, C44dgt-elt, C66, C66dgt, C66dgt-elt, C77, CE24, CW650-15, CW650-16, CW650-35, CW650-36, D120, D120dgt, D30, D36, D40, D40ELT, D40ELT-BT-BA, D45, D80, D80F, D85, LP130, LP60, LP60H, LP61, LP61H, LP70	





			
1			
código	511714	referencia	00222103
descripción	tubo de aclarado pos. de montaje arriba		
Para modelos:	B11, B15, BD11, BD13, BD14, BD14alt, BD22, BD46, BD47, BE35, BE40		

			
1			
código	511592	referencia	00011858 00014286
descripción	tubo de lavado L 730mm apto para ELFRAMO		
Para modelos:	BD50, BE50, BE50T, D30, D35, D36, D40, D40ELT, D40ELT-BT-BA, D40i, D40i-BT-BA, D40i-ELT-BT-BA, D45, D80		

			
1			
código	517505	referencia	00018260
descripción	tubo de lavado L 870mm inox		
Para modelos:	C44, C44dgt, C44dgt-elt, C66, C66dgt, C66dgt-elt, D120		

			
1			
código	511491	referencia	00000513 00005130
descripción	tubo de lavado ø 38mm L 214mm		
Para modelos:	120, 160, 906, 908		

			
1			
código	511492	referencia	00000511 00005110
descripción	tubo de lavado pos. de montaje abajo ø 34mm L 153mm		
Para modelos:	882, 885, SQ885, SQT80		

			
1			
código	511493	referencia	00000512 00005120
descripción	tubo de lavado pos. de montaje abajo ø 38mm L 176mm		
Para modelos:	120, 160, 906, 908		

			
1			
código	511489	referencia	00000514 00005140
descripción	tubo de lavado pos. de montaje abajo ø 39mm L 233mm		
Para modelos:	240, C34, C34dgt, C44, C44dgt, C44dgt-elt, C66, C66dgt, C66dgt-elt, C77, CE24, D120, D120dgt, LP60, LP60H, LP61, LP61H		

			
1			
código	511016	referencia	00005010
descripción	unión roscada		
Para modelos:	882, 885, LPE100, LPE145, SQ885, SQT80		

sistemas de lavado y aclarado (por fabricante)

ELFRAMO

			
1			
código	510207	referencia	00004930
descripción	boquilla de lavado completo		
Para modelos:	882, 885, SQ885, SQT80		



			
1			
código	511744	referencia	00004570
descripción	brazo de lavado L 190mm boquillas 1 rosca 1"		

			
1			
código	511745	referencia	00004580
descripción	brazo de lavado L 190mm boquillas 1 rosca 1"		

			
1			
código	510207	referencia	00004930
descripción	boquilla de lavado completo		
Para modelos:	882, 885, SQ885, SQT80		

			
1			
código	511746	referencia	00004590
descripción	brazo de lavado boquillas 1 rosca 1"		

			
1			
código	511747	referencia	00004610
descripción	brazo de lavado L 220mm boquillas 1 rosca 1"		

			
1			
código	511028	referencia	00202710
descripción	brazo de lavado L 320mm boquillas 4 montaje ø 15/59mm pos. de montaje abajo		
Para modelos:	42, 42E, 48, 48E, 55, 55E		
repuestos para	511028		
	código	511757	referencia 00202670
	descripción	brazo de lavado L 135mm boquillas 1 montaje ø 19mm	
	código	511758	referencia 00202680
	descripción	brazo de lavado L 135mm boquillas 1 montaje ø 19mm	
	código	511759	referencia 00202690
	descripción	brazo de lavado L 135mm boquillas 1 montaje ø 19mm	
	código	511760	referencia 00202700
	descripción	brazo de lavado L 135mm boquillas 1 montaje ø 19mm	
	código	511770	referencia 00202530
	descripción	resorte	
	código	511772	referencia —
	descripción	boquilla de lavado	

			
1			
código	511757	referencia	00202670
descripción	brazo de lavado L 135mm boquillas 1 montaje ø 19mm		
Para modelos:	42, 42E, 48, 48E, 55, 55E		

			
1			
código	511758	referencia	00202680
descripción	brazo de lavado L 135mm boquillas 1 montaje ø 19mm		
Para modelos:	42, 42E, 48, 48E, 55, 55E		



			
1			
código	511759	referencia	00202690
descripción	brazo de lavado L 135mm boquillas 1 montaje ø 19mm		
Para modelos:	42, 42E, 48, 48E, 55, 55E		

			
1			
código	511760	referencia	00202700
descripción	brazo de lavado L 135mm boquillas 1 montaje ø 19mm		
Para modelos:	42, 42E, 48, 48E, 55, 55E		

			
1			
código	511770	referencia	00202530
descripción	resorte		
Para modelos:	42, 42E, 48, 48E, 55, 55E, 60		







			
1			
código	511761	referencia	00202540
descripción	brazo de lavado L 165mm boquillas 1 montaje ø 19mm		
Para modelos:	42, 42E, 48, 48E, 55, 55E		





 <p>1</p>			
código	511762	referencia	00202550
descripción	brazo de lavado L 165mm boquillas 1 montaje ø 19mm		
Para modelos:	42, 42E, 48, 48E, 55, 55E		
repuestos para	511762		
	código	511772	referencia —
boquilla de lavado			

 <p>1</p>			
código	511763	referencia	00202560
descripción	brazo de lavado L 165mm boquillas 1 montaje ø 19mm		
Para modelos:	42, 42E, 48, 48E, 55, 55E		

 <p>1</p>			
código	511770	referencia	00202530
descripción	resorte		
Para modelos:	42, 42E, 48, 48E, 55, 55E, 60		

 <p>1</p>			
código	511029	referencia	00202830
descripción	brazo de lavado L 450mm boquillas 4 montaje ø 15/59mm pos. de montaje abajo		
Para modelos:	42, 42E, 48, 48E, 55, 55E, 60		
repuestos para	511029		
	código	511766	referencia 00202800
brazo de lavado L 200mm boquillas 1 montaje ø 19mm			
	código	511767	referencia 00202810
brazo de lavado L 200mm boquillas 1 montaje ø 19mm			
	código	511768	referencia 00202820
brazo de lavado L 200mm boquillas 1 montaje ø 19mm			
	código	511770	referencia 00202530
resorte			
	código	511772	referencia —
boquilla de lavado			

 <p>1</p>			
código	511766	referencia	00202800
descripción	brazo de lavado L 200mm boquillas 1 montaje ø 19mm		
Para modelos:	42, 42E, 48, 48E, 55, 55E, 60		

 <p>1</p>			
código	511767	referencia	00202810
descripción	brazo de lavado L 200mm boquillas 1 montaje ø 19mm		
Para modelos:	42, 42E, 48, 48E, 55, 55E, 60		

 <p>1</p>			
código	511768	referencia	00202820
descripción	brazo de lavado L 200mm boquillas 1 montaje ø 19mm		
Para modelos:	42, 42E, 48, 48E, 55, 55E		

 <p>1</p>			
código	511770	referencia	00202530
descripción	resorte		
Para modelos:	42, 42E, 48, 48E, 55, 55E, 60		

 <p>1</p>			
código	511074	referencia	00011340
descripción	boquilla de lavado		
Para modelos:	120, 160, 240, 906, 908, ET, ETA, ETE20, ETE21, ETE25, ETE27		

 <p>1</p>			
código	510004	referencia	00004940
descripción	boquilla de lavado rosca 1" ø 59mm H 27mm		
Para modelos:	120, 160, 240, 882, 885, 908		



1

código	511791	referencia	00011208
descripción	brazo de lavado L 180mm boquillas 1 montaje ø 27mm		
Para modelos:	120, 160, 906, 908		



1

código	511792	referencia	00011209
descripción	brazo de lavado L 180mm boquillas 1 montaje ø 27mm		
Para modelos:	120, 160, 906, 908		



1

código	511793	referencia	00011210
descripción	brazo de lavado L 180mm boquillas 1 montaje ø 27mm		
Para modelos:	120, 160, 906, 908		



1

código	511794	referencia	00011211
descripción	brazo de lavado L 180mm boquillas 1 montaje ø 27mm		
Para modelos:	120, 160, 906, 908		





1

código	511022	referencia	00011222
descripción	brazo de lavado pos. de montaje abajo		
Para modelos:	120, 160, 240, 906, 908		
repuestos para	511022		
	código	511074	referencia 00011340
	boquilla de lavado		
	código	511795	referencia 00011180
	brazo de lavado L 200mm boquillas 1 montaje ø 27mm		



1

código	511021	referencia	00011221
descripción	brazo de lavado pos. de montaje arriba		
Para modelos:	120, 160, 906, 908		
repuestos para	511021		
	código	511074	referencia 00011340
	boquilla de lavado		
	código	511795	referencia 00011180
	brazo de lavado L 200mm boquillas 1 montaje ø 27mm		



1

código	511074	referencia	00011340
descripción	boquilla de lavado		
Para modelos:	120, 160, 240, 906, 908, ET, ETA, ETE20, ETE21, ETE25, ETE27		



1

código	510004	referencia	00004940
descripción	boquilla de lavado rosca 1" ø 59mm H 27mm		
Para modelos:	120, 160, 240, 882, 885, 908		



1

código	511795	referencia	00011180
descripción	brazo de lavado L 200mm boquillas 1 montaje ø 27mm		
Para modelos:	120, 160, 906, 908		





1

código	511074	referencia	00011340
descripción	boquilla de lavado		
Para modelos:	120, 160, 240, 906, 908, ET, ETA, ETE20, ETE21, ETE25, ETE27		





 <p>1</p>			
código	510004	referencia	00004940
descripción	boquilla de lavado rosca 1" ø 59mm H 27mm		
Para modelos:	120, 160, 240, 882, 885, 908		

 <p>1</p>			
código	510004	referencia	00004940
descripción	boquilla de lavado rosca 1" ø 59mm H 27mm		
Para modelos:	120, 160, 240, 882, 885, 908		

 <p>1</p>			
código	511800	referencia	00011259
descripción	brazo de lavado L 220mm boquillas 1 montaje ø 27mm		
Para modelos:	240		

 <p>1</p>			
código	511800	referencia	00011259
descripción	brazo de lavado L 220mm boquillas 1 montaje ø 27mm		
Para modelos:	240		

 <p>1</p>			
código	511802	referencia	00011261
descripción	brazo de lavado L 220mm boquillas 1 montaje ø 27mm		
Para modelos:	240		

 <p>1</p>			
código	511802	referencia	00011261
descripción	brazo de lavado L 220mm boquillas 1 montaje ø 27mm		
Para modelos:	240		

 <p>1</p>			
código	511799	referencia	00011258
descripción	brazo de lavado L 220mm boquillas 2 montaje ø 27mm		
Para modelos:	240		

 <p>1</p>			
código	511799	referencia	00011258
descripción	brazo de lavado L 220mm boquillas 2 montaje ø 27mm		
Para modelos:	240		

 <p>1</p>			
código	511801	referencia	00011260
descripción	brazo de lavado L 220mm boquillas 2 montaje ø 27mm		
Para modelos:	240		

 <p>1</p>			
código	510207	referencia	00004930
descripción	boquilla de lavado completo		
Para modelos:	882, 885, SQ885, SQT80		

 <p>1</p>			
código	511074	referencia	00011340
descripción	boquilla de lavado		
Para modelos:	120, 160, 240, 906, 908, ET, ETA, ETE20, ETE21, ETE25, ETE27		

 <p>1</p>			
código	511813	referencia	00004520
descripción	brazo de lavado L 170mm boquillas 1 rosca 3/4"		
Para modelos:	882, 885, SQ885, SQT80		

 <p>1</p>			
código	511814	referencia	00004530
descripción	brazo de lavado L 195mm boquillas 1 rosca 3/4"		
Para modelos:	882, 885, SQ885, SQT80		

			
1			
código	511811	referencia	00004500
descripción	brazo de lavado L 200mm boquillas 1 rosca 3/4"		
Para modelos:	882, 885, SQ885, SQT80		

			
1			
código	511812	referencia	00004510
descripción	brazo de lavado L 200mm boquillas 1 rosca 3/4"		
Para modelos:	882, 885, SQ885, SQT80		

			
1			
código	511810	referencia	00004320
descripción	cruceta de brazo de lavado		
Para modelos:	882, 885, SQ885, SQT80		

			
1			
código	510163	referencia	ALT siehe 511.075/76
descripción	boquilla de aclarado		

			
1			
código	511756	referencia	00004950
descripción	boquilla de aclarado		
Para modelos:	882, 885, SQ885, SQT80		

			
1			
código	510163	referencia	ALT siehe 511.075/76
descripción	boquilla de aclarado		



			
1			
código	511756	referencia	00004950
descripción	boquilla de aclarado		
Para modelos:	882, 885, SQ885, SQT80		

			
1			
código	511805	referencia	00004820 00011186
descripción	brazo de aclarado L 215mm boquillas 2 rosca 1/4"		
Para modelos:	120, 160, 882, 885, 906, 908		

			
1			
código	511806	referencia	00004770 00011187
descripción	brazo de aclarado L 215mm boquillas 2 rosca 1/4"		
Para modelos:	120, 160, 882, 885, 906, 908, SQ885, SQT80		

			
1			
código	510163	referencia	ALT siehe 511.075/76
descripción	boquilla de aclarado		

			
1			
código	511756	referencia	00004950
descripción	boquilla de aclarado		
Para modelos:	882, 885, SQ885, SQT80		



			
1			
código	511773	referencia	00202720
descripción	brazo de aclarado L 315mm boquillas 4 montaje ø 14mm pos. de montaje arriba/abajo		
Para modelos:	42, 42E, 48, 48E, 55, 55E		
repuestos para	511773		
	código	511039	referencia 00011166
	perno de aclarado		
	código	511775	referencia 00202730
	brazo de aclarado L 130mm boquillas 2 rosca 1/4"		

			
1			
código	510163	referencia	ALT siehe 511.075/76
descripción	boquilla de aclarado		





			
1			
código	511756	referencia	00004950
descripción	boquilla de aclarado		
Para modelos:	882, 885, SQ885, SQT80		

			
1			
código	511775	referencia	00202730
descripción	brazo de aclarado L 130mm boquillas 2 rosca 1/4"		
Para modelos:	42, 42E, 48, 48E, 55, 55E		

			
1			
código	511774	referencia	00202600
descripción	brazo de aclarado L 375mm boquillas 4 montaje ø 14mm pos. de montaje arriba		
Para modelos:	42, 42E, 48, 48E, 55, 55E		
repuestos para	511774		
		código	511039
		referencia	00011166
		descripción	perno de aclarado
		código	511777
		referencia	00202610
		descripción	brazo de aclarado L 163mm boquillas 2 rosca 1/4"

			
1			
código	510163	referencia	ALT siehe 511.075/76
descripción	boquilla de aclarado		

			
1			
código	511756	referencia	00004950
descripción	boquilla de aclarado		
Para modelos:	882, 885, SQ885, SQT80		

			
1			
código	511777	referencia	00202610
descripción	brazo de aclarado L 163mm boquillas 2 rosca 1/4"		
Para modelos:	42, 42E, 48, 48E, 55, 55E		

			
1			
código	511778	referencia	00202620
descripción	brazo de aclarado L 163mm boquillas 2 rosca 1/4"		
Para modelos:	42, 42E, 48, 48E, 55, 55E		

			
1			
código	510163	referencia	ALT siehe 511.075/76
descripción	boquilla de aclarado		

			
1			
código	511756	referencia	00004950
descripción	boquilla de aclarado		
Para modelos:	882, 885, SQ885, SQT80		

			
1			
código	510163	referencia	ALT siehe 511.075/76
descripción	boquilla de aclarado		

			
1			
código	511756	referencia	00004950
descripción	boquilla de aclarado		
Para modelos:	882, 885, SQ885, SQT80		

			
1			
código	511805	referencia	00004820 00011186
descripción	brazo de aclarado L 215mm boquillas 2 rosca 1/4"		
Para modelos:	120, 160, 882, 885, 906, 908		

			
1			
código	511806	referencia	00004770 00011187
descripción	brazo de aclarado L 215mm boquillas 2 rosca 1/4"		
Para modelos:	120, 160, 882, 885, 906, 908, SQ885, SQT80		



1

código	511026	referencia	00011241
descripción	brazo de aclarado L 545mm boquillas 4 montaje ø 14mm completo		
Para modelos:	240		
repuestos para	511026		
	código	511039	referencia 00011166
	perno de aclarado		



1

código	510163	referencia	ALT siehe 511.075/76
descripción	boquilla de aclarado		



1

código	511756	referencia	00004950
descripción	boquilla de aclarado		
Para modelos:	882, 885, SQ885, SQT80		



1

código	511041	referencia	00210015
descripción	brazo de lavado L 328mm boquillas 3 pos. de montaje arriba rosca 3/4"		
Para modelos:	42, 42E, 48, 48E, 55, 55E		
repuestos para	511041		
	código	505073	referencia 06140005
	junta tórica EPDM espesor 2.62mm int.ø 20.63mm UE 1 pzs		
	código	511772	referencia —
	boquilla de lavado		



1

código	511042	referencia	00210016
descripción	brazo de lavado L 365mm boquillas 3 pos. de montaje arriba rosca 3/4"		
Para modelos:	42, 42E, 48, 48E, 55, 55E		
repuestos para	511042		
	código	505073	referencia 06140005
	junta tórica EPDM espesor 2.62mm int.ø 20.63mm UE 1 pzs		
	código	511772	referencia —
	boquilla de lavado		



1

código	511496	referencia	00220398
descripción	brazo de aclarado L 325mm boquillas 4 An 35mm		
Para modelos:	BE35		



1

código	511701	referencia	00220395
descripción	brazo de aclarado L 325mm boquillas 4 montaje ø 12mm pos. de montaje arriba/abajo		
Para modelos:	B11, BE35		



			
1			
código	511703	referencia	00222083 00222122 00222127
descripción	brazo de aclarado L 380mm boquillas 4 montaje ø 12mm pos. de montaje arriba/abajo		
Para modelos:	BD13, BD14, BD14alt, BD46, BD47, BE40		
repuestos para	511703		
	código	511704	referencia 00018076
	tornillo de cabeza moleteada		
	código	511705	referencia 00018106
	arandela		
	código	511706	referencia 00018228
	tuerca moleteada		
	código	511707	referencia 00014555 00018083 00018084
	boquilla de aclarado ø 8mm H 10mm EC		

			
1			
código	511702	referencia	00222000
descripción	brazo de lavado L 400mm boquillas 8 montaje ø 15/39,5mm pos. de montaje arriba/abajo		
Para modelos:	BD13, BD14, BD14alt, BD46, BD47, BE40		

			
1			
código	511723	referencia	00014045 00018287
descripción	brazo de lavado L 484mm boquillas 8 montaje ø 15/46mm pos. de montaje arriba/abajo		
Para modelos:	BD50, BE50, BE50T, D30, D35, D36, D40, D40ELT, D40ELT-BT-BA, D40i, D40i-BT-BA, D40i-ELT-BT-BA, D45		

			
1			
código	511480	referencia	00014194
descripción	brazo de aclarado L 500mm boquillas 6		
Para modelos:	C33, C44, C44dgt, C66, C66dgt, C77, D35, D40i, D40i-BT-BA, D40i-ELT-BT-BA, D80		

			
1			
código	511724	referencia	00014048
descripción	brazo de lavado L 485mm boquillas 11 montaje ø 15/46mm pos. de montaje arriba/abajo		
Para modelos:	BD50, BE50, C33, C34, C34dgt, CE24, CW650-15, CW650-16, CW650-35, CW650-36, D80, D80F, D85		

			
1			
código	511700	referencia	00211010
descripción	brazo de lavado L 350mm boquillas 7 montaje ø 14/39,5mm pos. de montaje arriba/abajo		
Para modelos:	B11, B15, BD11, BE35		

			
1			
código	511588	referencia	00018286
descripción	brazo de lavado L 485mm boquillas 11 montaje ø 15/60mm pos. de montaje arriba/abajo		



1

código	511737	referencia	00016851 00018190
descripción	brazo de lavado L 535mm boquillas 10 montaje ø 15/60mm pos. de montaje arriba/abajo		
Para modelos:	C44, C44dgt, C44dgt-elt, C66, C66dgt, C66dgt-elt, C77, D120, D120dgt		



1

código	511921	referencia	00052010
descripción	brazo de lavado L 655mm boquillas 24 montaje ø 15/80mm pos. de montaje arriba/abajo		
Para modelos:	LP130, LP70		



1

código	511924	referencia	00011216
descripción	brazo de lavado pos. de montaje arriba y abajo kit de transformación para ELFRAMO Mod. 160		



1

código	517497	referencia	00222005
descripción	brazo de lavado pos. de montaje arriba/abajo L 460mm boquillas 10		
Para modelos:	BD22		



1

código	511909	referencia	00011214
descripción	brazo de lavado y de aclarado kit de transformación para ELFRAMO Mod. 120		



1

código	517500	referencia	00065336
descripción	cruceta de brazo de lavado pos. de montaje arriba/abajo ø 99mm H 74mm		
Para modelos:	LP130, LP60, LP60H, LP61, LP61H, LP70		





1

código	511725	referencia	00018406
descripción	brazo de aclarado completo		
Para modelos:	C33, C44, C66, C77, D30, D40, D40ELT, D40ELT-BT-BA, D80		



1

código	511551	referencia	00018155 00222295	
descripción	brazo de aclarado L 480mm boquillas 6 montaje ø 12mm pos. de montaje arriba/abajo			
Para modelos:	BD22, BE50, BE50T, C33, C34, C34dgt, C44, C44dgt, C44dgt-elt, C66, C66dgt, C66dgt-elt, CE24, CW650-15, CW650-16, CW650-35, CW650-36, D30, D36, D40, D45, D80, D80F, D85			
repuestos para	511551			
	código	511704	referencia	00018076
	tornillo de cabeza moleteada			
	código	511705	referencia	00018106
	arandela			
	código	511706	referencia	00018228
	tuerca moleteada			



<p>1</p>			
código	517486	referencia	00079318 00090793 00090821 00095071
descripción	brazo de aclarado L 580mm boquillas 4		
Para modelos:	ETE20, ETE21, ETE25, ETE27, ETS15		

<p>1</p>			
código	519490	referencia	00065294 00065435
descripción	brazo de aclarado L 665mm boquillas 7 montaje ø 12mm pos. de montaje arriba/abajo An 29mm		
Para modelos:	LP130, LP70		

<p>1</p>			
código	517487	referencia	00065625
descripción	brazo de aclarado pos. de montaje arriba/abajo L 550mm boquillas 6 rosca M10x1,5		
Para modelos:	C77, D120, D120dgt, LP60, LP60H, LP61, LP61H		

<p>1</p>			
código	511707	referencia	00014555 00018083 00018084
descripción	boquilla de aclarado ø 8mm H 10mm EC		
Para modelos:	B11, B15, BD11, BD13, BD14, BD14alt, BD22, BD50, BE40, BE50, BE50T, C33, C34, C34dgt, C44, C44dgt, C44dgt-elt, C66, C66dgt, C66dgt-elt, C77, CE24, CW650-15, CW650-16, CW650-35, CW650-36, D120, D120dgt, D30, D36, D40, D40ELT, D40ELT-BT-BA, D45, D80, D80F, D85, EN, ET, ET020, ETE20, ETE21, ETE25, ETE27, ETS15, LP130, LP60, LP60H, LP61, LP61H...(Otros modelos se puede ver en la tienda web)		

<p>1</p>			
código	511586	referencia	00072360
descripción	brazo de aclarado L 636mm boquillas 7 pos. de montaje arriba/abajo rosca 3/4"		
Para modelos:	EN, ET, ETA		

<p>1</p>			
código	511587	referencia	00052150 00072350
descripción	brazo de aclarado L 638mm boquillas 7 pos. de montaje izquierdo rosca 3/4"		
Para modelos:	EN, ET, ET020, ETA		

<p>1</p>			
código	511072	referencia	00004960 old version
descripción	boquilla de aclarado		

<p>1</p>			
código	511621	referencia	00000496 00004960 00007237 00072370
descripción	boquilla de aclarado boquilla de aclarado int.ø 2.5mm		
Para modelos:	120, 160, 240, 882, 885, 908, EN, ET, ETA, ETE20, ETE21, ETE25, ETE27, LPE100, LPE145		

<p>1</p>			
código	512408	referencia	00082549
descripción	brazo de lavado L 625mm boquillas 4 montaje ø 41mm pos. de montaje arriba/abajo con pasador para prelavado ELFRAMO		
Para modelos:	EN, ET, ET020		



1

código	517501	referencia	00079102
descripción	boquilla de lavado pos. de montaje arriba/abajo H 18mm ø 24.4mm		
Para modelos:	EN, ET, ET020, ETE20, ETE21, ETE25, ETE27, ETS15		



1

código	511077	referencia	00004931
descripción	boquilla de lavado		



1

código	511640	referencia	00011839
descripción	portatubos de lavado ø 40mm rosca M32x2,5		



1

código	511715	referencia	00222104
descripción	contrasoporte pos. de montaje abajo para soporte de brazo de lavado		
Para modelos:	BD13, BD14, BD14alt, BD22, BD46, BD47, BE40		



1

código	511719	referencia	00012710
descripción	contrasoporte pos. de montaje abajo para soporte de brazo de lavado		
Para modelos:	B11, B15, BD11, BD50, BE35, BE50, BE50T, C33, CW650-15, CW650-16, CW650-35, CW650-36, D120, D30, D35, D36, D40, D40ELT, D40ELT-BT-BA, D40i, D40i-BT-BA, D40i-ELT-BT-BA, D45, D80, D80F, D85		



1

código	511785	referencia	00202781
descripción	contrasoporte pos. de montaje abajo para soporte de brazo de lavado		
Para modelos:	42, 42E, 48, 48E, 55, 55E, 60		



1

código	511461	referencia	00004260 old version
descripción	soporte de brazo de lavado		



1

código	511717	referencia	00222101
descripción	soporte de brazo de lavado		
Para modelos:	BD14, BD14alt, BD47		



1

código	511735	referencia	00014040
descripción	soporte de brazo de lavado		
Para modelos:	D30, D35, D40, D40ELT, D40ELT-BT-BA, D40i, D40i-BT-BA, D40i-ELT-BT-BA		



1

código	511736	referencia	00014055
descripción	soporte de brazo de lavado		
Para modelos:	BD50, BE50, BE50T, D36, D45, D80		



1

código	511036	referencia	00004260 00011152
descripción	soporte de brazo de lavado pos. de montaje abajo		
Para modelos:	882, 885, SQ885, SQT80		





1

código	511038	referencia	00011195
descripción	soporte de brazo de lavado pos. de montaje abajo		
Para modelos:	120, 160, 240, 906, 908		





			
1			
código	511721	referencia	00211014
descripción	soporte de brazo de lavado pos. de montaje abajo		
Para modelos:	B11, B15, BD11, BD13, BD14, BD22, BD46, BE35, BE40		

			
1			
código	511740	referencia	00018063
descripción	soporte de brazo de lavado pos. de montaje abajo		
Para modelos:	C34, C34dgt, C44, C44dgt, C44dgt-elt, C66, C66dgt, C66dgt-elt, C77, CE24, D120, D120dgt		

			
1			
código	511710	referencia	00011851
descripción	soporte de brazo de lavado pos. de montaje arriba		
Para modelos:	BD13, BD14, BD14alt, BD22, BD46, BD47, BD50, BE40, BE50, BE50T, C33, CW650-15, CW650-16, CW650-35, CW650-36, D30, D35, D36, D40, D40ELT, D40ELT-BT-BA, D40i, D40i-BT-BA, D40i-ELT-BT-BA, D45, D80, D80F, D85		

			
1			
código	511738	referencia	00018062
descripción	soporte de brazo de lavado pos. de montaje arriba		
Para modelos:	C34, C34dgt, C44, C44dgt, C44dgt-elt, C66, C66dgt, C66dgt-elt, C77, D120, D120dgt		

			
1			
código	511784	referencia	00014020 00014021
descripción	soporte de brazo de lavado pos. de montaje arriba		
Para modelos:	60		

			
1			
código	511037	referencia	00011194
descripción	soporte de brazo de lavado pos. de montaje arriba rosca 1½"		
Para modelos:	240, 906, 908		

			
1			
código	511035	referencia	00004270
descripción	soporte de brazo de lavado rosca 1¼" pos. de montaje arriba		

pernos de aclarado

			
1			
código	511032	referencia	00005000
descripción	perno de aclarado		

			
1			
código	511039	referencia	00011166
descripción	perno de aclarado		
Para modelos:	120, 160, 240, 42, 42E, 48, 48E, 55, 55E, 60, 906, 908		

pomos

pomos personalizados para fabricantes

ELFRAMO			
			
1			
código	111220	referencia	00033270
descripción	pomo interruptor marca cero		

			
1			
código	110056	referencia	00006500
descripción	pomo interruptor marca cero ø 55mm eje ø 5x5mm parte plana horizontal negro		
Para modelos:	EB12, EB12+12, EB18P, EB6, EB6+6, EB8, EM12, EM12+12, EM20, EM20+20, EM20+20-900, EM20-900, EM35, EM40-900, ES12, ES20, ESD12, ESD20, FE12, FE20, FE20+20, FE30, FE30+30, KES20, KESD20, ST12, ST12+12, ST7, ST7+7		



1

código	110005	referencia	00033241
descripción	pomo interruptor marca cero ø 55mm eje ø 6x4,6mm parte plana arriba negro		
Para modelos:	EB6, EB6+6		



1

código	110006	referencia	00033250
descripción	pomo interruptor marca cero ø 55mm eje ø 6x4,6mm parte plana arriba negro		
Para modelos:	EB12, EB12+12, EB18P, EB6, EB6+6, EB8, EM12, EM12+12, EM20, EM20+20, EM20+20-900, EM20-900, EM35, EM40-900, ES12, ES20, ESD12, ESD20, FE12, FE20, FE20+20, FE30, FE30+30, GSDT12, GSDT20, GST12, GST20, GVM35T, GW209T, GWD209T, GWDT12, GWDT20, GWT12, GWT20, KES20, KESD20, ST12, ST12+12, ST7, ST7+7		



1

código	110055	referencia	00006520
descripción	pomo interruptor marca cero ø 60mm eje ø 5x5mm negro		
Para modelos:	LPE100, LPE145		



1

código	112684	referencia	00038683
descripción	pomo termostato de gas 1-8 ø 55,5mm eje ø 6x4,6mm parte plana arriba negro		
Para modelos:	GSDT12, GSDT20, GST12, GST20, GVM35T, GWDT12, GWDT20, GWT12, GWT20		



1

código	110878	referencia	00035809 00035813
descripción	pomo termostato de gas 1-8 T máx°C ø 52mm eje ømm parte plana Minisit negro eje especial		
Para modelos:	GM2532, GM2542, GMD2532, GMD2542, GW12, GW20, GWD12, GWD20		

manillas y volantes

asas de arco



1

código	511100	referencia	00001510 00009200
descripción	asa de arco		



1

código	511115	referencia	00001530 00009220
descripción	asa de arco L 445mm H 62mm distancia de sujeción 425mm		

empuñaduras



1

código	511889	referencia	00205530
descripción	empuñadura		
Para modelos:	42, 42E, 48, 48E, 55, 55E, 60, B11, B15, BD11, BD13, BD14, BD14alt, BD46, BD47, BE35, BE40, EM12, EM12+12, EM20, EM20+20		



1

código	511890	referencia	00010610
descripción	empuñadura		
Para modelos:	120, 160, 240, 882, 885, BD22, BD50, BE50, BE50T, D120, D120dgt, D30, D35, D36, D40, D40ELT, D40ELT-BT-BA, D40i, D40i-BT-BA, D40i-ELT-BT-BA, D45, D80, D80F, D85		

grifería para cocinas industriales

grifos de caño

universal



1

código	541609	referencia	00030401	
descripción	grifo de salida latón cromado An 46mm H 40mm rosca 1" F			
Para modelos:	EB12, EB12+12, EB6, EB6+6, EB8, FG12M, FG24M, GB10, GBD10			
repuestos para	541609			
	código	540747	referencia	—
	grifo de salida latón cromado acodado An 30mm H 40mm rosca 1/2" H			



grifos de vaciado

latón

grifos de vaciado



código	540260	referencia	00030400
descripción	grifo de vaciado		
Para modelos:	EB12, EB12+12, EB18P, EB6, EB6+6, EB8		

pies para aparatos y tapas terminales

pies enroscables

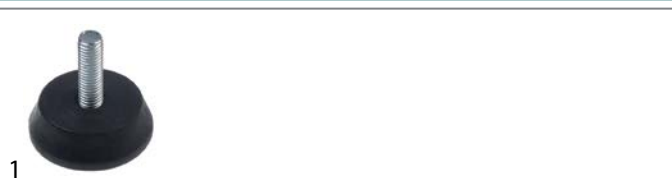

código	695604	referencia	00000970 00000980 00013783
descripción	pie de aparato rosca M10 rosca L 32mm ø 50mm H 14mm		
Para modelos:	882, 885, BD14, BD14alt, BD22, BD46, BD47, C33, C44, C66, D30, D35, D36, D40, D40ELT, D40ELT-BT-BA, D40i, D40i-BT-BA, D40i-ELT-BT-BA, D45, D80, EB12, EB12+12, EB18P, EB6, EB6+6, EB8, EM12, EM12+12, EM20, EM20+20, EM20+20-900, EM20-900, EM35, EM40-900, ET, ET020, ETA, ETE20, ETE21, ETE25, ETE27, ETS15, GM12, GM12+12, GM20+20, GM20+20-900, GM25+25-900, GM25-900, GM35...(Otros modelos se puede ver en la tienda web)		



código	695601	referencia	00206960
descripción	pie de aparato rosca M17 rosca L 23mm ø 24mm H 11mm plástico EC 24 UE 1 pzs		
Para modelos:	42, 42E, 48, 48E, 55, 55E, 60, B11, B15, BD11, BD13, BD50, BE35, BE40, BE50, BE50T, EB12, EB12+12, EB6, EB6+6, EB8		

cestos

cestos para freidoras

ELFRAMO



código	970190	referencia	00030560
descripción	cesto de freidora L1 265mm B1 180mm H1 120mm L2 480mm H2 215mm acero cromado		
Para modelos:	EB6, EB6+6, EM12		



código	970193	referencia	00030581 00030581neu,o.Griffe
descripción	cesto de freidora L1 288mm B1 107mm H1 120mm		
Para modelos:	EB12, EB12+12, EM12, EM12+12, GM12+12		



código	970277	referencia	00035842
descripción	cesto de freidora L1 290mm B1 105mm H1 120mm L2 230mm H2 235mm acero cromado		



código	970191	referencia	00030570 00030570 o.Griffe
descripción	cesto de freidora L1 290mm B1 180mm H1 120mm L2 520mm H3 230mm acero cromado		
Para modelos:	EB12, EB8		



código	970278	referencia	00035805
descripción	cesto de freidora L1 290mm B1 215mm H1 120mm L2 410mm H3 240mm acero cromado		
Para modelos:	ES12, ESD12, FG125, FG12M, FG24M, GB10, GBD10, GM2532, GMD2532, GST12, GW12, GW12ELT, GWD12, GWD12ELT, GWDT12, GWT12		



1

código	970192	referencia	00030580 00030580 no Man.Cest
descripción	cesto de freidora L1 290mm B1 235mm H1 120mm acero cromado		
Para modelos:	EB12, EB12+12, EB8, EM12, EM12+12, EM20, EM20+20, FE12, GM12+12		



1

código	970286	referencia	00030611
descripción	cesto de freidora L1 365mm B1 265mm H1 120mm acero cromado		
Para modelos:	EM35, GM35, GVM35, GVM35T		



1

código	970284	referencia	00003059 00030590
descripción	cesto de freidora L1 370mm B1 240mm H1 120mm L2 230mm H2 232mm H3 232mm acero cromado		
Para modelos:	EM12, EM12+12, EM20, EM20+20, FE20, FE20+20, FE30, FE30+30, GM20+20		



1

código	970279	referencia	00030591 00035843 3059A
descripción	cesto de freidora L1 375mm B1 105mm H1 120mm acero cromado		
Para modelos:	EM20, EM20+20, ES20, ESD20, FE20, FE20+20, FE30, FE30+30, FG157, FG159, FG307, FG309, GM20+20, GM2542, GMD2542, GST20, GW20, GW209T, GW20ELT, GWD20, GWD209T, GWD20ELT, GWDT20, GW-MODULARI, GWT20, KES20, KESD20		



1

código	970281	referencia	00035806
descripción	cesto de freidora L1 375mm B1 215mm H1 120mm acero cromado		
Para modelos:	ES20, ESD20, FG157, FG159, FG307, FG309, GM2532, GM2542, GMD2542, GST20, GW20, GW209T, GW20ELT, GWD20, GWD209T, GWD20ELT, GWDT20, GW-MODULARI, GWT20, KES20, KESD20		



1

código	970590	referencia	00030610
descripción	cesto de freidora L1 540mm B1 365mm H1 120mm acero cromado		
Para modelos:	EM35, GM35, GVM35, GVM35T		



1

código	970591	referencia	BFR0005
descripción	cesto de freidora L1 620mm B1 360mm H1 65mm		

cestos de lavado

cestos de alambre de acero redondos

cestas de lavado



1

código	970514	referencia	00206731
descripción	cesta para vajillas diversas ø ext. 330mm H 145mm		
Para modelos:	42, 42E, 48, 48E, 55, 55E, B11, BD11, BE35		



1

código	970515	referencia	00007400
descripción	cesta para vajillas diversas ø ext. 440mm H 145mm soporte ø 445mm		
Para modelos:	120, 160, 240, 42, 42E, 48, 48E, 55, 55E, 882, 885, 904, 906, 908, 912, BD22, SQ885, SQT80		



1

código	970516	referencia	00007420
descripción	cesta para vajillas diversas ø ext. 500mm H 125mm soporte ø 445mm		
Para modelos:	120, 160, 240, 882, 885, 904, 906, 908, 912		

cestas para platos



1

código	970513	referencia	00007320
descripción	cesto para platos ø ext. 495mm H 120mm soporte ø 445mm platos 18		
Para modelos:	120, 160, 240, 882, 885, 904, 906, 908, 912		

cestos de alambre de acero cuadrado

cestas para vasos



1

código	971052	referencia	00206720
descripción	cesta para vasos L 470mm An 470mm H 150mm cantidad de filas 3 distancia entre filas 145mm		
Para modelos:	42, 42E, 48, 48E, 55, 55E, 60, BD22		

cestas de lavado



1

código	970078 ¹	referencia	00007100
descripción	cesta para vajillas diversas		
Para modelos:	120, 160, 240, 882, 885, 904, 906, 908, 912		

¹de malla gruesa



1

código	971006 ¹	referencia	00206711
descripción	cesta para vajillas diversas L 345mm An 345mm H 120mm tipo de maneta de malla gruesa		
Para modelos:	42, 42E, 48, 48E, 55, 55E, B11, BD11		

¹de malla gruesa



1

código	970068 ¹	referencia	00206712
descripción	cesta para vajillas diversas L 400mm An 400mm H 170mm		
Para modelos:	42, 42E, 48, 48E, 55, 55E, B15, BD13, BD14, BD46, BD47		
repuestos para	970068		
	código	970001	referencia —
	esquina deslizando espesor de hilo 5mm L 120mm An 120mm H 12mm L-Form		

¹de malla gruesa



1

código	971049 ¹	referencia	00206713 X098E006/710
descripción	cesta para vajillas diversas L 460mm An 460mm		
Para modelos:	42, 42E, 48, 48E, 55, 55E, 60, BD22		

¹de malla gruesa



1

código	970074 ¹	referencia	00007120
descripción	cesta para vajillas diversas L 500mm An 500mm H 130mm tipo de maneta de malla fina		
Para modelos:	120, 160, 240, 882, 885, 904, 906, 908, 912, BD50, BE50, BE50T, C33, C34, C34dgt, C44, C44dgt, C44dgt-elt, C66, C66dgt, C66dgt-elt, CE24, D30, D35, D36, D40, D40ELT, D40ELT-BT-BA, D40i, D40i-BT-BA, D40i-ELT-BT-BA, D45, D80, D85, SQ885, SQT80		

¹de malla fina



1

código	970027 ¹	referencia	00007140
descripción	cesta para vajillas diversas L 550mm An 550mm H 125mm tipo de maneta de malla fina		
Para modelos:	120, 160, 240, 882, 885, 904, 906, 908, 912, C77, D120, D120dgt		

¹de malla fina

cestas para platos



1

código	971051	referencia	00007000
descripción	cesto para platos L 470mm An 470mm H 100mm platos 16 plato ø 240mm		
Para modelos:	120, 160, 240, 42, 42E, 48, 48E, 55, 55E, 60, 882, 885, 904, 906, 908, 912, BD22		



1

código	971043	referencia	00007020 00007040
descripción	cesto para platos L 500mm An 500mm H 130mm platos 20 plato ø 240mm		
Para modelos:	120, 160, 240, 882, 885, 904, 906, 908, 912, BD50, BE50, BE50T, C33, C34, C34dgt, C44, C44dgt, C44dgt-elt, C66, C66dgt, C66dgt-elt, CE24, D30, D35, D36, D40, D40ELT, D40ELT-BT-BA, D40i, D40i-BT-BA, D40i-ELT-BT-BA, D45, D80, D85, SQ885, SQT80		



código	970026	referencia	00007060 X098E012/706
descripción	cesto para platos L 550mm An 550mm H 130mm platos 24 plato ø 270mm		
Para modelos:	120, 160, 240, 882, 885, 904, 906, 908, 912, C77, D120, D120dgt		

cestos de plástico cuadrado

cestas de lavado



código	971058	referencia	00206701
descripción	cesta para vajillas diversas L 350mm An 350mm H 150mm		
Para modelos:	BE35		

cestas sistema GIADOS 500x500mm

cestas universales



código	976030	referencia	FAA028
descripción	cesta para bandejas L 500mm An 500mm H 116mm bandejas 9		
Para modelos:	160, 882, 885		

accesorios

cuarteros



código	976016	referencia	00206721
descripción	complemento para cubiertos L 110mm An 110mm ømm H 130mm		



código	976011	referencia	00206721
descripción	complemento para cubiertos Lmm Anmm ø 110mm H 130mm		

complementos para platos



código	970047	referencia	00007200 00206751 00206752
descripción	complemento para platos L 308mm An 100mm platos 15		
Para modelos:	120, 160, 240, 42, 42E, 48, 48E, 55, 55E, 60, 882, 885, 904, 906, 908, 912, B11, B15, BD11, BD13, BD14, BD22, BD46, BD47, BD50, BE35, BE40, BE50, BE50T, C33, C34, C34dgt, C44, C44dgt, C44dgt-elt, C66, C66dgt, C66dgt-elt, C77, CE24, D120, D120dgt, D30, D35, D36, D40, D40ELT, D40ELT-BT-BA, D40i, D40i-BT-BA...(Otros modelos se puede ver en la tienda web)		

juntas

juntas tóricas

EPDM

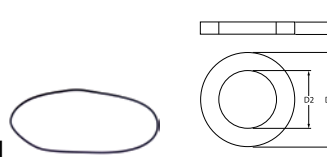

código	521717	referencia	00000290 00002900 06140008 06140140
descripción	junta tórica EPDM espesor 1.78mm int.ø 120.37mm UE 1 pzs		
Para modelos:	42, 42E, 48, 48E, 55, 55E, 60, 882, 885, BD22, C33, C34, C34dgt, D30, D35, D36, D40, D40ELT, D40ELT-BT-BA, D40i, D40i-BT-BA, D40i-ELT-BT-BA, D45, D80, D80F, D85, SQ885, SQT80		

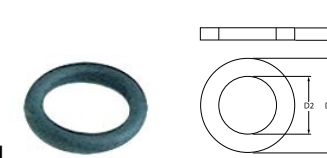

código	529412	referencia	06140003
descripción	junta tórica EPDM espesor 2.62mm int.ø 10.78mm UE 1 pzs		

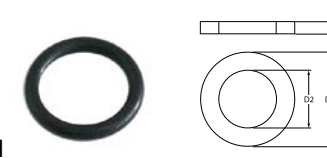

código	507313	referencia	06140002
descripción	junta tórica EPDM espesor 2.62mm int.ø 13.95mm UE 1 pzs		
Para modelos:	BD14, BD14alt, C33, D30, D40, D80		

código	528919	referencia	00004480 06140005
descripción	junta tórica EPDM espesor 2.62mm int.ø 20.24mm UE 1 pzs		
Para modelos:	42, 42E, 48, 48E, 55, 55E, 60, 882, 885, B11, BD11, BE35, SQ885, SQT80		

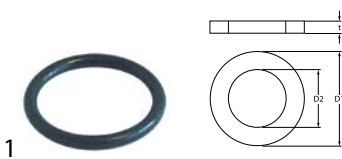

código	505073	referencia	06140005
descripción	junta tórica EPDM espesor 2.62mm int.ø 20.63mm UE 1 pzs		



código	510769	referencia	06140004
descripción	junta tórica EPDM espesor 2.62mm int.ø 25.07mm UE 1 pzs		
Para modelos:	B11, B15, BD13, BD14, BD14alt, BD46, BD47, BE35, C44, C44dgt, C44dgt-elt, C66, C66dgt, C66dgt-elt, C77, D40, D40ELT, D40ELT-BT-BA, D40i-ELT-BT-BA, D45		

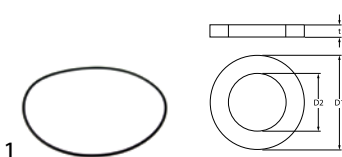

código	521718	referencia	00002910 06140010
descripción	junta tórica EPDM espesor 3.53mm int.ø 164.7mm UE 1 pzs		
Para modelos:	120, 160, 906, 908, C44, C44dgt, C44dgt-elt, C66, C66dgt, C66dgt-elt, C77, D120, D120dgt, EN, ET, ET020, ETA, ETE20, ETE21, ETE25, ETE27, ETS15		

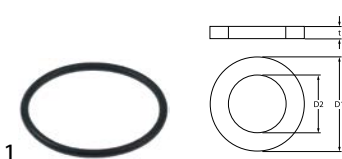

código	532451	referencia	06140028
descripción	junta tórica EPDM espesor 3.53mm int.ø 53.98mm UE 1 pzs		
Para modelos:	ETE20, ETE21, ETE25, ETE27, ETS15		



código	511828	referencia	06140018
descripción	junta tórica EPDM espesor 3.53mm int.ø 56.74mm UE 1 pzs		
Para modelos:	B11, B15, BD11, BD13, BD14, BD14alt, BD22, BD46, BD47, BD50, BE35, BE40, BE50, BE50T, C33, C34, C34dgt, C44, C44dgt, C44dgt-elt, C66, C66dgt, C66dgt-elt, C77, CE24, CW650-15, CW650-16, CW650-35, CW650-36, D120, D120dgt, D30, D35, D36, D40, D40ELT, D40ELT-BT-BA, D40i, D40i-BT-BA, D40i-ELT-BT-BA, D45, D80, D80F, D85, ETE20, ETE21, ETE25, ETE27, ETS15, LP60...(Otros modelos se puede ver en la tienda web)		



código	511711	referencia	06140026
descripción	junta tórica EPDM espesor 3.53mm int.ø 78.97mm UE 1 pzs		
Para modelos:	B11, B15, BD11, BD13, BD14, BD14alt, BD22, BD46, BD47, BD50, BE35, BE40, BE50, BE50T, C33, C34, C34dgt, C44, C44dgt, C44dgt-elt, C66, C66dgt, C66dgt-elt, C77, CW650-15, CW650-16, CW650-35, CW650-36, D120, D120dgt, D30, D35, D36, D40, D40ELT, D40ELT-BT-BA, D40i, D40i-BT-BA, D40i-ELT-BT-BA, D45, D80, D80F, D85		

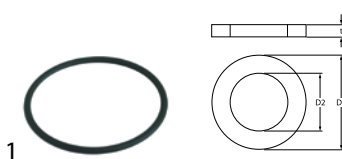

código	505178	referencia	06140035
descripción	junta tórica EPDM espesor 5.34mm int.ø 85.09mm UE 1 pzs		
Para modelos:	ETE20, ETE21, ETE25, ETE27, ETS15		



código	521154	referencia	06140046
descripción	junta tórica int.ø 152.7mm espesor 2.62mm EPDM UE 1 pzs		
Para modelos:	C66dgt		

anillos de junta

juntas de fibra



código	506042	referencia	06110006 06120004
descripción	junta plana FIBER ø ext. 27mm int.ø 17mm espesor 2mm UE 1 pzs		
Para modelos:	C34dgt, C44, C44dgt, C66, C66dgt, C77, CE24, D120, D120dgt, LP130		



1

código	511490	referencia	06120001
descripción	junta plana fibra ø ext. 15mm int.ø 8mm espesor 2mm UE 1 pzs		
Para modelos:	B11, B15, BD11, BD13, BD14, BD14alt, BD22, BD47, BE35, BE40, BE50, C33, C34, C34dgt, C44, C44dgt, C44dgt-elt, C66, C66dgt, C66dgt-elt, C77, CE24, CW650-15, CW650-16, CW650-35, CW650-36, D120, D30, D40, D40ELT, D40ELT-BT-BA, D40i-BT-BA, D40i-ELT-BT-BA, D80, D80F, D85, LP130		

juntas de plástico



1

código	696375	referencia	00010504
descripción	junta plástico ø ext. 19mm int.ø 10.5mm espesor 6mm para calentador de agua UE 1 pzs		
Para modelos:	B11, BD11, BD13, BD14, BD14alt, BD22, BD46, BD47, BD50, BE35, BE40, BE50, BE50T, C33, C34, C34dgt, C44, C44dgt, C44dgt-elt, C66, C66dgt, C66dgt-elt, C77, CE24, D120, D120dgt, D30, D35, D36, D40, D40ELT, D40ELT-BT-BA, D40i, D40i-ELT-BT-BA, D45, D80, D80F, D85, GFP25, GFP25AC, GFU25, GFU25AC, LP130, LP61, LP61H, LP70		



1

código	696557	referencia	06113001
descripción	junta plana polioximileno ø ext. 14mm int.ø 10mm espesor 1.5mm UE 1 pzs		
Para modelos:	BD46, BD47, BD50, BE50, BE50T, C44dgt, C44dgt-elt, C66dgt, C66dgt-elt, D120, D120dgt, D35, D36, D40i, D40i-BT-BA, D40i-ELT-BT-BA, D45, D80, D85		

juntas de cobre

DIN-7603-A



1

código	560523	referencia	02150006
descripción	junta plana cobre niquelado ø ext. 18.5mm int.ø 12.2mm espesor 2mm UE 1 pzs		
Para modelos:	BD46, BD47, BD50, BE40, BE50, C33, C34, C34dgt, C44, C66, C77, D120, D35, D36, D40i, D40i-BT-BA, D40i-ELT-BT-BA, D45, D80, D85		

juntas de PTFE



1

código	511589	referencia	06112001
descripción	junta plana PTFE ø ext. 11mm int.ø 4.5mm espesor 2mm UE 1 pzs		
Para modelos:	BD13, BD14, BD46, BD47, BD50, BE35, BE40, BE50, C33, C34, C34dgt, C44, C44dgt, C44dgt-elt, C66, C66dgt, C66dgt-elt, C77, D120, D120dgt, D35, D36, D40, D40i, D40i-ELT-BT-BA, D45, D80, D85, GFP25, GFP25AC, GFU25, GFU25AC		

juntas de árbol

juntas en V



1

código	511213	referencia	00530523
descripción	anillo en V		
Para modelos:	Cybergel, EM240, EM360, EM480, EM612, EM-HT		

juntas especiales

otros



1

código	511106	referencia	00000147 00001470
descripción	junta de ventana		

muelles

resortes de compresión



1

código	511117	referencia	0000235A 00073718
descripción	resorte de compresión ø 14,2/8,1mm L 53mm espesor de hilo 1.2mm cónico		

resortes enrollados

resortes enrollados



1

código	519550	referencia	00079740
descripción	resorte enrollado An 25.35mm		
Para modelos:	ETE20, ETE21, ETE25, ETE27		



1

código	519491	referencia	00079730
descripción	resorte enrollado An 26mm		
Para modelos:	ETE20, ETE21, ETE25, ETE27, ETS15, LP130, LP60H, LP61H, LP70		



1

código	519543	referencia	00065816
descripción	resorte enrollado con soporte An 46mm int.ømm longitud de lengüeta mm		
Para modelos:	LP130, LP60, LP60H, LP61, LP61H		



1

código	511127	referencia	00002300	
descripción	resorte enrollado pos. de montaje derecho completo			
repuestos para	511127			
	código	511622	referencia	00002310
	resorte enrollado pos. de montaje derecho/izquierdo An 40mm			



1

código	511622	referencia	00002310
descripción	resorte enrollado pos. de montaje derecho/izquierdo An 40mm		



1

código	511116	referencia	00002301 0000230A	
descripción	resorte enrollado pos. de montaje izquierdo completo			
repuestos para	511116			
	código	511622	referencia	00002310
	resorte enrollado pos. de montaje derecho/izquierdo An 40mm			

resortes de tracción



1

código	511875	referencia	00013717 00013719
descripción	muelle de tracción		
Para modelos:	BD14, BD14alt, BD22, D40, D40ELT, D40ELT-BT-BA, D40i, D40i-BT-BA, D40i-ELT-BT-BA, D80, D80F		



1

código	511904	referencia	00013717
descripción	muelle de tracción ø 15.1mm longitud total 148mm espesor de hilo 1.7mm		
Para modelos:	BD14, BD46, BD47, D36, D40, D40i, D40i-ELT-BT-BA, D45, D80, D85, ET, ETE20, ETE21, ETE25, ETE27, ETS15		



1

código	511216	referencia	00018056
descripción	muelle de tracción ø 25mm longitud total 790mm espesor de hilo 5mm L1 120mm L2 580mm D1 ø 23mm rosca M8 rosca L 90mm pos. de montaje izquierdo/derecho para campana		
Para modelos:	C34, C34dgt, C44, C44dgt, C44dgt-elt, C66, C66dgt, C66dgt-elt, C77, CE24		



1

código	361593	referencia	00000812
descripción	resorte		

dosificadores

bombas dosificadoras



SEKO

versión empotrada





con control de frecuencia



1

código	361215	referencia	20155100 20155111 old version	
descripción	dosificador SEKO regulación de frecuencia 0,3-3,0l/h 230VAC detergente tubo ø 4x6mm tipo de tubo K tubo Santoprene altura de aspiración 1.5m tipo PBR protección IP55 medidas 100x67x68mm consumo 3.5W			
Para modelos:	42, 42E, 48, 48E, 55, 55E, 60, B11, B15, BD11, BD13, BD14, BD14alt, BD22, C33, C44, C66, D120, D30, D40, D80, D80F, LP130, LP60, LP70			
repuestos para	361215			
	código	361136	referencia	—
	enrollador manguera para dosificadoras agujero ø 4,8x4mm			
	código	361226	referencia	—
	placa electrónica L 59mm An 26mm regulación electrónica			

Continúa en la página siguiente

repuestos para	361215		
	código	361815	referencia 20155112
	tubo flexible para bomba detergente tubo ø 6x10mm tubo ø 4x6mm tipo de tubo K tubo Santoprene tipo SEKO		
accesorios para	361215		
	código	361142	referencia —
	kit de montaje detergente tipo de tubo 4x6mm longitud de tubo 2m PVC 2x tubo flexible/filtro recipiente/caño de pared transparente		
	código	520090	referencia 07125002
	tubo flexible de PVC int.ø 4mm ø ext. 6mm L 2m grosor de la pared 1mm T máx 60°C transparente		
	código	520091	referencia 20155110
	tubo de nylon int.ø 4mm ø ext. 6mm L 2m grosor de la pared 1mm p de trabajo 10bar p de reventamiento 50bar T máx 100°C transparente		

	código	362025	referencia	20155111
	descripción	dosificador SEKO regulación de frecuencia 0,3-3,0l/h 230VAC detergente tubo ø 4x6mm tubo Santoprene tipo NBR 3 con accesorios acodado 90°		
	Para modelos:	B11, BD11, BD13, BD14, BD22, BD46, BD47, BD50, BE35, BE40, BE50, BE50T, C33, C34, C34dgt, C44, C44dgt, C44dgt-elt, C66, C66dgt, C66dgt-elt, C77, CW650-15, CW650-16, CW650-35, CW650-36, D120, D120dgt, D30, D35, D36, D40, D40ELT, D40ELT-BT-BA, D40i, D40i-ELT-BT-BA, D45, D80, D80F, D85, EN, ET, ETS15, LP130, LP60, LP60H, LP61, LP61H, LP70		

con temporizador

	código	361768 ¹	referencia	00220423 old version 20155104 old version
	descripción	dosificador SEKO control temporizado 0.4l/h 230VAC abrillantador tubo ø 4x6mm tipo de tubo D tubo Sekobril altura de aspiración 1.5m tipo NBM 0.4 8W con accesorios 8VA tiempo de dosificación 0-30s		
repuestos para	361768			
	código	361135	referencia	20155109
	tubo flexible para bomba SEKO abrillantador tubo ø 3x8mm tubo ø 4x6mm tipo de tubo D tubo Sekobril			
	código	361141	referencia	20155105
	filtro de recipiente con pesa cerámica tubo ø 4mm			
	código	361821	referencia	00220419
	válvula de retención entrada 4x6mm salida 1/4" L 45mm			
	código	520091	referencia	20155110
	tubo de nylon int.ø 4mm ø ext. 6mm L 2m grosor de la pared 1mm p de trabajo 10bar p de reventamiento 50bar T máx 100°C transparente			



¹con accesorios

repuestos para	361768		
	código	520242	referencia —
	tubo de silicona para bomba peristáltica int.ø 4mm ø ext. 7mm L 5m grosor de la pared 1.5mm T máx 200°C Shore A 55° transparente sistemas de dosificación UE 5m		

	código	362024	referencia	20155104 20155104 new version
	descripción	dosificador SEKO control temporizado 0.4l/h 230VAC abrillantador tubo ø 4x6mm tipo de tubo Sekobril tipo NBM 0.4 con accesorios acodado 90°		
	Para modelos:	B11, B15, BD11, BD13, BD14, BD14alt, BD22, BD46, BD47, C33, C44, C44dgt, C44dgt-elt, C66, C66dgt, C66dgt-elt, CW650-15, CW650-16, CW650-35, CW650-36, D120, D120dgt, D30, D36, D40, D40ELT, D45, D80, D80F, D85, LP130, LP60, LP60H, LP70		

piezas de repuesto

	código	361815	referencia	20155112
	descripción	tubo flexible para bomba detergente tubo ø 6x10mm tubo ø 4x6mm tipo de tubo K tubo Santoprene tipo SEKO		
	Para modelos:	B11, BD11, BD13, BD14, BD22, BD46, BD47, BD50, BE35, BE40, BE50, C33, C34, C34dgt, C44, C44dgt, C66, C66dgt, C77, CW650-15, CW650-16, CW650-35, CW650-36, D120, D120dgt, D30, D35, D36, D40, D40ELT, D40ELT-BT-BA, D40i, D40i-ELT-BT-BA, D45, D80, D80F, D85, EN, ET, ETE20, ETE21, ETE25, ETE27, ETS15, LP130, LP60, LP60H, LP61, LP61H, LP70		

	código	361135	referencia	20155109
	descripción	tubo flexible para bomba SEKO abrillantador tubo ø 3x8mm tubo ø 4x6mm tipo de tubo D tubo Sekobril		
	Para modelos:	B11, BD11, BD13, BD14, BD22, BD46, BD47, C33, C34, C34dgt, C44, C44dgt, C66, C66dgt, CW650-15, CW650-16, CW650-35, CW650-36, D120, D120dgt, D30, D35, D36, D40, D40ELT, D45, D80, D80F, D85, EN, ET, ETE20, ETE21, ETE25, ETE27, ETS15, LP130, LP60, LP60H, LP70		
repuestos para	361135			
	código	361866	referencia	—
	tuerca de racor para empalme de tubo ø 17mm			



bombas de membrana

autoaspirantes

LARGO

accesorios



1			
código	361083	referencia	00220413
descripción	tuerca de racor G1: M10x1 para tubo flexible 6mm		

SEKO



1			
código	361594	referencia	20155108
descripción	dosificador tipo DIB3E abrillantador caudal 0-3cm ³ por carrera empalme presión ø 4x6mm conector para succión ø 4x6mm		
Para modelos:	BD13, BD14, BD46, BD47, BD50, BE35, BE40, BE50, C33, C34, C34dgt, C44, C44dgt, C66, C66dgt, C77, D120, D30, D35, D36, D40, D40ELT, D40ELT-BT-BA, D40i, D40i-ELT-BT-BA, D45, D80, D85, LP130, LP60, LP60H, LP61, LP61H, LP70		
repuestos para	361594		
	código	361240	referencia —
	empalme de tubo 1 vía tubo ø 6mm plástico empalme M10x1		
	código	361301	referencia —
	empalme de tubo para tipo DIB3E/DIB5E		
	código	361302	referencia —
	casquillo de válvula para tipo DIB3E/DIB5E		
	código	361304	referencia —
	junta tórica EPDM int.ø 11.11mm espesor 1.78mm UE 1 pzs para tipo DIB3E/DIB5E		
	código	361305	referencia —
	disco de válvula para tipo DIB3E/DIB5E DIB3P/DIB5P		
	código	361306	referencia —
	membrana para tipo DIB3E/DIB5E ø 49mm agujero ø 5mm		
	código	361481	referencia —
	válvula labial para tipo DIB3P/DIB5P DIB3E/DIB5E		



1			
código	361837 ¹	referencia	2015511+00019656 20155117
descripción	dosificador tipo DIB5E kit de modificación abrillantador caudal 0-5cm ³ por carrera empalme presión ø 4x6mm conector para succión ø 6mm SEKO		
Para modelos:	BD46, BD47, BE35, BE40, BE50, BE50T, C34, C44dgt, C44dgt-elt, C66dgt, C66dgt-elt, CE24, D120dgt, D36, D45, LP61, LP61H		
repuestos para	361837		
	código	361301	referencia —
	empalme de tubo para tipo DIB3E/DIB5E		
	código	361302	referencia —
	casquillo de válvula para tipo DIB3E/DIB5E		
	código	361304	referencia —
	junta tórica EPDM int.ø 11.11mm espesor 1.78mm UE 1 pzs para tipo DIB3E/DIB5E		
	código	361305	referencia —
	disco de válvula para tipo DIB3E/DIB5E DIB3P/DIB5P		
	código	361306	referencia —
	membrana para tipo DIB3E/DIB5E ø 49mm agujero ø 5mm		
	código	361307	referencia —
	membrana dosificador ø 68mm agujero ø 6mm para tipo DIB3P/DIB5P		
	código	361481	referencia —
	válvula labial para tipo DIB3P/DIB5P DIB3E/DIB5E		
accesorios para	361837		
	código	361240	referencia —
	empalme de tubo 1 vía tubo ø 6mm plástico empalme M10x1		
	código	361241	referencia —
	empalme de tubo 1 vía tubo ø 9mm plástico empalme M10x1		

¹empalme de presión secundaria cerrado

accesorios



1			
código	361141	referencia	20155105
descripción	filtro de recipiente con pesa cerámica tubo ø 4mm		
Para modelos:	B11, BD11, BD13, BD14, BD22, C33, C44, C66, CW650-15, CW650-16, CW650-35, CW650-36, D120, D30, D40, D40ELT, D80, D80F		

válvulas de retención

			
1			
código	361821	referencia	00220419
descripción	válvula de retención entrada 4x6mm salida 1/4" L 45mm		
Para modelos:	B11, BD13, BD22, BD46, BD47, C33, C34, C34dgt, C44, C44dgt, C44dgt-elt, C66, C66dgt, C66dgt-elt, C77, D120, D120dgt, D30, D35, D36, D40, D40ELT, D40ELT-BT-BA, D40i, D45, D80, D85, LP130, LP60, LP60H, LP61, LP61H, LP70		

			
1			
código	361147	referencia	20155106
descripción	válvula de retención entrada 4x6mm salida 1/8" L 50mm UE 1 pzs		
Para modelos:	B11, BD11, BD13, BD14, BD22, C33, C44, C66, CW650-15, CW650-16, CW650-35, CW650-36, D120, D30, D40, D40ELT, D80, D80F, LP130, LP70		

tubos flexibles



tubos de dosificación

			
1			
código	511164	referencia	00003780
descripción	tubo flexible de dosificación ø ext. 10mm int.ø 6mm L 1800mm sistemas de dosificación		

tubos flexibles de PVC



			
1			
código	520090	referencia	07125002
descripción	tubo flexible de PVC int.ø 4mm ø ext. 6mm L 2m grosor de la pared 1mm T máx 60°C transparente		
Para modelos:	B11, B15, BD11, BD13, BD14, BD14alt, BD22, BD50, BE35, BE40, BE50, C33, C34, C34dgt, C44, C66, C77, CE24, CW650-15, CW650-16, CW650-35, CW650-36, D120, D30, D35, D40, D40ELT, D40ELT-BT-BA, D40i, D40i-ELT-BT-BA, D80, D80F, EN, ET, ET020, ETA, ETE20, ETE21, ETE25, ETE27, ETS15, LP130, LP60, LP60H, LP61, LP61H, LP70		
accesorios para	520090		
	código	361058	referencia —
	filtro de recipiente con válvula antirretorno inox tubo ø 4x6mm ø 20mm L 56mm		
	código	361066	referencia —
	filtro de recipiente recto inox tubo ø 4x6mm L 37mm válvula de retención válvula de bola		
	código	361106	referencia —
	filtro de recipiente con pesa y válvula de retención inox tubo ø 4x6mm ø 21mm L 51mm válvula de retención válvula labial		
	código	361141	referencia 20155105
	filtro de recipiente con pesa cerámica tubo ø 4mm		

DOSIFICADORES/TUBOS FLEXIBLES ELFRAMO

accesorios para	520090		
	código	361230	referencia —
	filtro de recipiente con pesa acero inoxidable tubo ø 4x6mm		
	código	361462	referencia —
	filtro de recipiente con pesa inox tubo ø 4x6mm		
	código	361728	referencia —
	filtro de recipiente con 4m 4x6 tubo flexible inox tubo ø 4x6mm longitud de tubo 4000mm		

racores de tubo flexible

plástico

			
1			
código	511593	referencia	00220440
descripción	empalme de tubos en forma de T plástico rosca 1/2" ø 13mm para dosificadoras		
repuestos para	511593		
	código	361083	referencia 00220413
	tuerca de racor G1: M10x1 para tubo flexible 6mm		

caños de pared



			
1			
código	361416	referencia	20155114
descripción	caño de pared inox M12 tubo ø 6mm		
Para modelos:	B11, BD13, BD14, BD46, BD47, BD50, BE35, BE40, BE50, BE50T, C33, C34, C34dgt, C44, C44dgt, C44dgt-elt, C66, C66dgt, C66dgt-elt, C77, D120, D120dgt, D30, D35, D36, D40, D40ELT, D40ELT-BT-BA, D40i, D40i-ELT-BT-BA, D45, D80, D85, EN, ET, ETE20, ETE21, ETE25, ETE27, ETS15, LP130, LP60, LP60H, LP61, LP61H, LP70		

tubos flexibles

tubos flexibles de entrada

tubos flexibles inoxidables

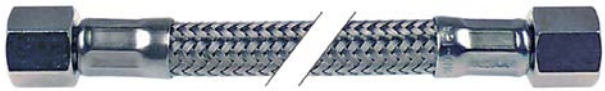
tubos flexibles universales

			
1			
			
código	520627	referencia	00053360
descripción	latiguillo flexible trenza inox recto-recto DN12 empalmes 3/4" L 2000mm homologación DVGW p de trabajo 10bar presión de prueba 32bar p de reventamiento 95bar		
Para modelos:	EN, ET, ETA		



1

código	520395	referencia	00000354 00003540
descripción	latiguillo flexible trenza inox recto-recto DN8 empalmes 3/8"-1/2" L 230mm UE 2 pzs		

1

código	520459	referencia	00003530
descripción	latiguillo flexible trenza inox recto-recto DN8 empalmes 3/8"-1/2" L 740mm homologación DVGW p de trabajo 10bar presión de prueba 32bar p de reventamiento 95bar		
Para modelos:	CW650-15, CW650-16, CW650-35, CW650-36, LP70		

1

código	520396	referencia	00000355 00003550
descripción	latiguillo flexible inox recto-curvado L 170mm empalmes 3/8"-1/2"		

1

código	520008	referencia	00053060 00053090 00053100 00053120 00053130
descripción	latiguillo flexible trenza inox recto-curvado DN12 empalme 1: 3/4" empalme 2: 3/4" L 1500mm homologación DVGW p de trabajo 10bar presión de prueba 32bar p de reventamiento 95bar		
accesorios para	520008		
	código	520054	referencia —
	junta plana goma ø ext. 23.5mm int.ø 14mm espesor 2.3mm UE 10 pzs		

1

código	520007	referencia	336A
descripción	latiguillo flexible trenza inox recto-curvado DN15 empalme 1: 3/4" empalme 2: 3/4" L 2500mm homologación p de trabajo 10bar presión de prueba 32bar p de reventamiento 95bar		

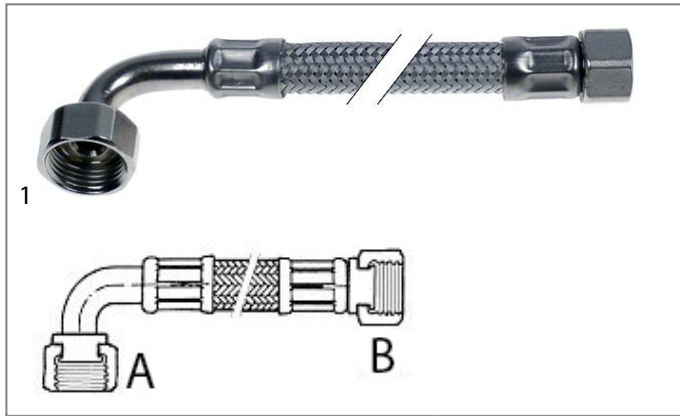

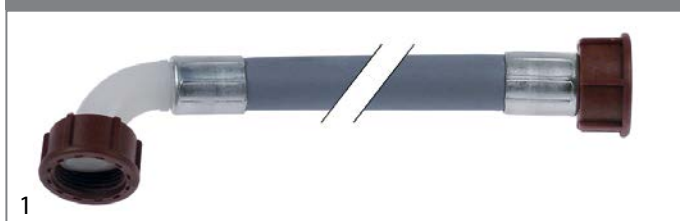

código	520468	referencia	12160008
descripción	latiguillo flexible trenza inox recto-curvado DN8 empalme 1: 1/2" empalme 2: 3/8" L 350mm homologación DVGW p de trabajo 10bar presión de prueba 32bar p de reventamiento 95bar		
Para modelos:	BE35, BE40		

tubos flexibles de entrada de PVC



código	520010	referencia	00200720 07130001 07130002
descripción	tubo flexible de entrada PVC recto-curvado DN13 empalmes 3/4" L 1500mm p de trabajo 10bar p de reventamiento 32bar T máx 90°C azul homologación VDE cierre plana		
Para modelos:	120, 160, 240, 42, 42E, 48, 48E, 55, 55E, 60, 882, 885, 904, 906, 908, 912, B11, B15, BD11, BD13, BD14, BD14alt, BD22, BD46, BD47, BD50, BE35, BE40, BE50, BE50T, C33, C34, C34dgt, C44, C44dgt, C44dgt-elt, C66, C66dgt, C66dgt-elt, C77, CE24, D120, D120dgt, D30, D35, D36, D40, D40ELT, D40ELT-BT-BA, D40i...(Otros modelos se puede ver en la tienda web)		
accesorios para	520010		

	código	520053	referencia	—
				filtro empalme 3/4" D1 ø 26mm D2 ø 15mm UE 10 pzs goma espesor 8mm
	código	520054	referencia	—
				junta plana goma ø ext. 23.5mm int.ø 14mm espesor 2.3mm UE 10 pzs

tubos flexibles de ducha

tubos flexibles inoxidables



código	542859	referencia	00980050
descripción	tubo de ducha empalmes 1/2" L 1200mm inox p de trabajo 10bar p de reventamiento 90bar T máx 90°C para duchas lavavajillas apto para agua potable giratorio con tejido flexible		
Para modelos:	C33, C34, C34dgt, C44, C44dgt, C44dgt-elt, C66, C66dgt, C66dgt-elt, C77, ET, ETA		

tubos de salida



código	511206	referencia	07130157
descripción	manguera de desagüe		
Para modelos:	42, 42E, 48, 48E, 55, 55E, 60, B11, BD11, BD13, BD14, BD22, BD50, BE35, BE40, BE50, BE50T, D30, D35, D36, D40, D40ELT, D40ELT-BT-BA, D40i, D40i-ELT-BT-BA, D45, D80		

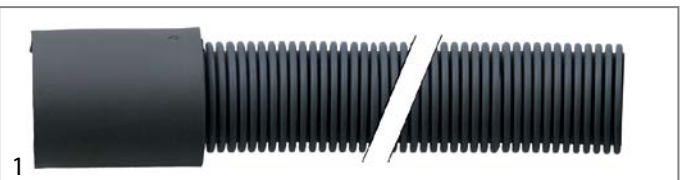

código	513718	referencia	00003630 00003640 00200652 00200653
descripción	manguera de desagüe DN19 L 1500mm ø int. recta 24mm ø ext. recto 28mm tubo ø ext. 23mm		

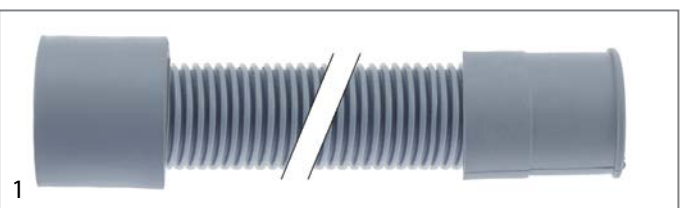

código	511205	referencia	0000364 07130156
descripción	manguera de desagüe DN19 L 1500mm A ø interno 23mm A ø externo 29mm B ø interno 29mm tubo ø ext. 29mm B ø externo 35mm		

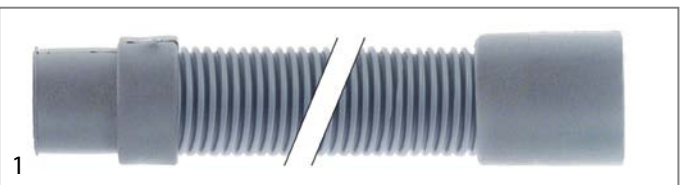

código	530608	referencia	00003630 00003640 00200652 00200653 07130155 07130156
descripción	manguera de desagüe DN24 L 1500mm A ø interno 24mm A ø externo 28mm B ø interno 28mm B ø externo 35mm tubo ø ext. 29mm resis.a la temp. 90°C		

Para modelos:	120, 160, 240, 42, 42E, 48, 48E, 55, 55E, 60, 882, 885, 906, 908, B11, B15, BD11, BD13, BD14, BD14alt, BD22, BD46, BD47, BD50, BE35, BE40, BE50, BE50T, C33, C34, C34dgt, C44, C44dgt, C44dgt-elt, C66, C66dgt, C66dgt-elt, C77, D120, D120dgt, D30, D35, D36, D40, D40ELT, D40ELT-BT-BA, D40i, D40i-BT-BA, D40i-ELT-BT-BA, D45...(Otros modelos se puede ver en la tienda web)		
----------------------	---------------------------------------------------------------------------------------------------------------------------------------------------------------------------------------------------------------------------------------------------------------------------------------------------------------------------------------------------------------------------------	--	--



			
1			
código	530399	referencia	07130158
descripción	manguera de desagüe DN31 L 2000mm A ø interno 33mm A ø externo 39mm B ø interno 33mm B ø externo 39mm tubo ø ext. 35mm		
Para modelos:	C33, C34, C34dgt, C44, C44dgt, C44dgt-elt, C66, C66dgt, C66dgt-elt, C77, CE24, CW650-15, CW650-16, CW650-35, CW650-36, D120, D120dgt, D30, D40, D80, D80F, D85, LP60, LP60H, LP61, LP61H		

tubos flexibles industriales

tubos de nylon

			
1			
código	520091	referencia	20155110
descripción	tubo de nylon int.ø 4mm ø ext. 6mm L 2m grosor de la pared 1mm p de trabajo 10bar p de reventamiento 50bar T máx 100°C transparente		
Para modelos:	B11, BD11, BD13, BD14, BD22, C33, C44, C66, CW650-15, CW650-16, CW650-35, CW650-36, D120, D30, D40, D40ELT, D80, D80F		

tubos flexibles de PVC

tubos de PVC sin tejido

			
1			
código	520090	referencia	07125002
descripción	tubo flexible de PVC int.ø 4mm ø ext. 6mm L 2m grosor de la pared 1mm T máx 60°C transparente		
Para modelos:	B11, B15, BD11, BD13, BD14, BD14alt, BD22, BD50, BE35, BE40, BE50, C33, C34, C34dgt, C44, C66, C77, CE24, CW650-15, CW650-16, CW650-35, CW650-36, D120, D30, D35, D40, D40ELT, D40ELT-BT-BA, D40i, D40i-ELT-BT-BA, D80, D80F, EN, ET, ET020, ETA, ETE20, ETE21, ETE25, ETE27, ETS15, LP130, LP60, LP60H, LP61, LP61H, LP70		

accesorios para	520090		
	código	referencia	
	361058		—
	filtro de recipiente con válvula antirretorno inox tubo ø 4x6mm ø 20mm L 56mm		
	361066		—
	filtro de recipiente recto inox tubo ø 4x6mm L 37mm válvula de retención válvula de bola		
	361106		—
	filtro de recipiente con pesa y válvula de retención inox tubo ø 4x6mm ø 21mm L 51mm válvula de retención válvula labial		
	361141	referencia	20155105
	filtro de recipiente con pesa cerámica tubo ø 4mm		
	361230	referencia	—
	filtro de recipiente con pesa acero inoxidable tubo ø 4x6mm		
	361462	referencia	—
	filtro de recipiente con pesa inox tubo ø 4x6mm		
	361728	referencia	—
	filtro de recipiente con 4m 4x6 tubo flexible inox tubo ø 4x6mm longitud de tubo 4000mm		

tubos de silicona

sin tejido

			
1			
código	530410	referencia	00003750 00011065
descripción	tubo de silicona int.ø 4mm ø ext. 7mm L 2m grosor de la pared 1.5mm T máx 200°C transparente		
Para modelos:	120, 160, 240, 42, 42E, 48, 48E, 55, 55E, 60, 882, 885, 904, 906, 908, 912, B11, BD11, BD13, BD14, BD22, BD46, BD47, BD50, BE35, BE40, BE50, BE50T, C33, C34, C34dgt, C44, C44dgt, C44dgt-elt, C66, C66dgt, C66dgt-elt, C77, D120, D120dgt, D30, D35, D36, D40, D40ELT, D40ELT-BT-BA, D40i, D40i-BT-BA, D45, D80...(Otros modelos se puede ver en la tienda web)		

tubos formados

recto

			
1			
código	511048	referencia	00004060 00072970 00200671 00200676 00200678
descripción	tubo formado lavavajillas recto núm. Ref. 00004060		
Para modelos:	120, 160, 42, 42E, 48, 48E, 55, 55E, 906, 908, C34, C44, C44dgt, C44dgt-elt, C66, C66dgt, C66dgt-elt, C77, CE24, D120, D120dgt, EN, ET, ET020, ETA, ETE20, ETE21, ETE25, ETE27		

			
1			
código	511858	referencia	00013827 00222217
descripción	tubo formado lavavajillas recto núm. Ref. 00013827		
Para modelos:	BD22, C33, CW650-15, CW650-16, CW650-35, CW650-36, D30, D35, D36, D40, D40ELT, D40ELT-BT-BA, D40i, D40i-BT-BA, D40i-ELT-BT-BA, D45, D80, D80F, D85		

forma L



1

código	511050	referencia	00004070 00065552
descripción	tubo formado altura interior 50mm medida interior 70mm L 190mm sistemas de lavado L-Form núm. Ref. 00004070		
Para modelos:	240, LP60, LP60H, LP61, LP61H		



1

código	511140	referencia	00010540
descripción	tubo formado sistemas de lavado L-Form núm. Ref. 00010540		
Para modelos:	120, 160		

con derivación



1

código	511855	referencia	00210956
descripción	tubo de presión		



1

código	511857	referencia	00210956 00222108
descripción	tubo de presión		
Para modelos:	B11, B15, BD11, BD13, BD14, BD14alt, BD46, BD47, BE35		



1

código	511863	referencia	00206901
descripción	tubo de presión		
Para modelos:	42, 42E, 48, 48E, 55, 55E		



1

código	511056	referencia	00206911
descripción	tubo formado sistemas de lavado con derivación		
Para modelos:	42, 42E, 48, 48E, 55, 55E		



1

código	511057	referencia	00206912
descripción	tubo formado sistemas de lavado con derivación		
Para modelos:	42, 42E, 48, 48E, 55, 55E		



1

código	511058	referencia	00206909
descripción	tubo formado sistemas de lavado con derivación		
Para modelos:	42, 42E, 48, 48E, 55, 55E, 60		



1

código	511859	referencia	00013718
descripción	tubo formado sistemas de lavado núm. Ref. 00013718 con derivación		
Para modelos:	BD50, BE50, BE50T, C33, CW650-15, CW650-16, CW650-35, CW650-36, D30, D35, D36, D40, D40ELT, D40ELT-BT-BA, D40i, D40i-BT-BA, D40i-ELT-BT-BA, D45, D80, D80F, D85		

forma S



1

código	511856	referencia	00222109
descripción	tubo formado forma S sistemas de lavado núm. Ref. 00222109		
Para modelos:	BD14, BD14alt, BD47, BE35		



1

código	517498	referencia	00018312
descripción	tubo formado ø tubo 78mm int. ø tubo 63mm L 310mm forma S		
Para modelos:	C44, C44dgt, C44dgt-elt, C66, C66dgt, C66dgt-elt, C77, D120, D120dgt		

otros



1

código	511047	referencia	00004110
descripción	tubo formado sistemas de lavado núm. Ref. 00004110		

para lavavajillas

otros



1

código	511468	referencia	00200691
descripción	tubo de presión		
Para modelos:	42, 42E, 48, 48E, 55, 55E		



1

código	511467	referencia	00003520 00013411
descripción	tubo de presión L 1000mm		



1

código	511464	referencia	00013340
descripción	tubo de presión L 480mm ø 18mm		



1

código	511465	referencia	00200641
descripción	tubo de presión L 690mm ø 25mm		
Para modelos:	42, 42E, 48, 48E, 55, 55E, 60		