



resistencias

resistencias secas para lavavajillas



código	420561	referencia	12048965
descripción	resistencia 2800W 230V espirales 1 L 325mm An 55mm H 40mm tubo ø 6.5mm empalme F6,3x0,8 resistencia seca lavavajillas		
Para modelos:	CO-500, CO-500B, CO-500BDD, CO-500DD, CO-501, CO-501B, CO-501BDD, CO-501DD, CO-501-SOFT, CO-502B, CO-502BDD, CO-502DD, CO-502W, COP-503, COP-503B, COP-503BDD, COP-503DD, COP-503-SOFT, COP-504, COP-504B, COP-504BDD, COP-504DD, COP-504W		

resistencias de tubo de aletas



código	418969	referencia	12024856 Z276391
descripción	resistencia 1500W 230V L 455mm An 50mm H 25mm tubo ø 8mm rosca M12x1,25 empalme M4 espirales 1		
Para modelos:	ECO-160, ECO-160D, ECO-160I, ECO-200, ECO-200D, ECO-200H, ECO-200HD, ECO-200HI, ECO-200I, ECO-2700D, ECO-2700I, ECO-280D, ECO-280I, ECO-370D, ECO-370I, ECO-4000D, ECO-4000I, ECO-460D, ECO-460I, ECO-550D, ECO-550I, ECO-6000D, ECO-6000I, FI-160, FI-160AR, FI-160D, FI-160I, FI-200, FI-200AR, FI-200D, FI-200H, FI-200HD, FI-200HI, FI-200I, FI-200W, FI-200WL, FI-200WR, FI-2700D, FI-2700I, FI-280D, FI-280I, FI-370D, FI-370I, FI-4000D, FI-4000I, FI-460D, FI-460I, FI-550D, FI-550I, FI-6000D... (Otros modelos se puede ver en la tienda web)		

resistencias de inmersión

brida 3 orificios ø 57,5mm



código	415021	referencia	12024713 Z313601
descripción	resistencia 6000W 230V montaje ø 57.5mm espirales 3 L 343mm An 37mm H 50mm casquillo portasondas 1 ø casquillo portasondas 7mm longitud casquillo portasondas 294mm casquillo termostato no ajustado tubo ø 8.5mm dist. del agujero 72mm agujero ø 8mm empalme M5 brida 3 orificios		
Para modelos:	ECO-2700D, ECO-2700I, ECO-280D, ECO-280I, ECO-370D, ECO-370I, ECO-4000D, ECO-4000I, ECO-460D, ECO-460I, ECO-550D, ECO-550I, ECO-6000D, ECO-6000I, FI-2700D, FI-2700I, FI-280D, FI-280I, FI-370D, FI-370I, FI-4000D, FI-4000I, FI-460D, FI-460I, FI-550D, FI-550I, FI-6000D, FI-6000I		
repuestos para	415021		
	código	510409	referencia 12010040 Q307044
accesorios para	415021		
	código	550002	referencia —
	estribo de fijación H 10mm L 21mm An 10mm agujero ø 6.5mm para resistencia		

	código	418798	referencia	12024214 12040415 Z121740 Z121741
descripción	resistencia 9600W 230V montaje ø 57.5mm espirales 3 L 545mm An 36mm H 53mm casquillo portasondas 1 ø casquillo portasondas 7mm longitud casquillo portasondas 190mm tubo ø 8mm dist. del agujero 73mm agujero ø 8mm empalme M4			
Para modelos:	ECO-160, ECO-160D, ECO-160I, ECO-200, ECO-200D, ECO-200H, ECO-200HD, ECO-200HI, ECO-200I, ECO-2300, ECO-2700D, ECO-2700I, ECO-3000, ECO-4000D, ECO-4000I, ECO-6000D, ECO-6000I, FI-160, FI-160D, FI-160AR, FI-160I, FI-200, FI-200AR, FI-200D, FI-200H, FI-200HD, FI-200HI, FI-200I, FI-200WL, FI-200WR, FI-2300, FI-2700D, FI-2700I, FI-280D, FI-280I, FI-3000, FI-370D, FI-370I, FI-4000D, FI-4000I, FI-460D, FI-460I, FI-550D, FI-550I, FI-6000D, FI-6000I			
accesorios para	418798			
	código	510409	referencia	12010040 Q307044
	junta tórica EPDM espesor 5.34mm int.ø 56.52mm UE 1 pzs			

con brida 3 orificios ø60,0mm

empalme recto

grupo 1





código	420325	referencia	12024721 Z129502
descripción	resistencia 12000W 230V montaje ø 60mm espirales 3 L 545mm An 36mm H 41mm casquillo portasondas 1 ø casquillo portasondas 7mm longitud casquillo portasondas 175mm casquillo termostato descentrado, no ceñido tubo ø 8.5mm dist. del agujero 73mm agujero ø 10mm empalme M4 brida 3 orificios resistencia de inmersión		
Para modelos:	ECO-6000D, ECO-6000I, FI-160D, FI-160I, FI-200AR, FI-200D, FI-200HD, FI-200HI, FI-200I, FI-200W, FI-2700D, FI-2700I, FI-4000D, FI-4000I, FI-460D, FI-460I, FI-550D, FI-550I, FI-6000D, FI-6000I		



código	420324	referencia	12024740 Z101720 Z101740
descripción	resistencia 6000W 230V montaje ø 60mm espirales 3 L 545mm An 36mm H 41mm casquillo portasondas 1 ø casquillo portasondas 7mm longitud casquillo portasondas 175mm casquillo termostato descentrado, no ceñido tubo ø 8.5mm dist. del agujero 73mm agujero ø 10mm empalme M4 brida 3 orificios resistencia de inmersión		
Para modelos:	ECO-1600, ECO-2300, ECO-280D, ECO-280I, ECO-3000, ECO-370D, ECO-370I, ECO-460D, ECO-460I, ECO-550D, ECO-550I, FI-1600, FI-2300, FI-280D, FI-280I, FI-3000, FI-370D, FI-370I, FI-460D, FI-460I, FI-550D, FI-550I		

con brida de expansión 70 x 18mm



código	416380	referencia	12024986 Z733601
descripción	resistencia 1000W 230V espirales 1 brida 70x18mm L 273mm An 63mm H 27mm empalme M4 resistencia de inmersión brida de expansión tubo ø 6.5mm		
Para modelos:	ECO-120, LVC-12, LVC-15, LVC-21, LVR-10		
accesorios para	416380		
	código	510429	referencia —
	junta L 76mm An 23mm dist. del agujero 25mm 3 orificios para resistencia tipo DB 70 sin guía sonda termostato		



código	416381	referencia	12024951 R223005
descripción	resistencia 2000W 230V espirales 1 brida 70x18mm L 280mm An 78mm H 22mm empalme M4 resistencia de inmersión brida de expansión tubo ø 8.5mm		
Para modelos:	AD-15, AD-15D, AD-20C-UK, AD-21, AD-21B, AD-21BDD, AD-21C, AD-21D, AD-21DD, AD-21W, AD-45BBT, BME7-05, BME7-10, BME9-10, BME9-10AD, BME9-10PLUS, BME9-10V-T, FI-30, FI-30AR, FI-30AR+DD, FI-30B-BT-UK, FI-30-UK, LVC-12, LVC-15, LVC-15D, LVC-21, LVC-21B, LVC-21C, LVC-21D, LVC-21W, LVR-14, LVR-14D, LVR-20, LVR-20B, LVR-20D, MF-21		
accesorios para	416381		
	código	510429	referencia —
	junta L 76mm An 23mm dist. del agujero 25mm 3 orificios para resistencia tipo DB 70 sin guía sonda termostato		



código	416382	referencia	12024645 Z203601
descripción	resistencia 2800W 230V espirales 1 brida 70x18mm L 370mm An 102mm H 27mm resistencia de inmersión tubo ø 8.5mm		
Para modelos:	AD-48, AD-48B, AD-48BDD, AD-48C, AD-48D, AD-48DD, AD-48HY, AD-48W, AD-64, AD-64B, AD-64BBT, AD-64BDD, AD-64BTDD, AD-64C, AD-64CW, AD-64D, AD-64DD, AD-64HY, AD-72, AD-72W, BME9-05, BME9-05AD, BME9-05PLUS, BME9-05V-T, EASY-500, EASY-500B, EASY-500DD, EASY-500HP, EASY-500HPWBDD, ECO-120, ECO-120B, FI-100, FI-120, FI-120W, FI-30, FI-30AR, FI-30AR+DD, FI-30B, FI-30-UK, FI-48, FI-48AR, FI-48B, FI-48B-BT-UK, FI-48C, FI-48D, FI-48HY-CLINIC, FI-48W, FI-50, FI-60DD, FI-64...(Otros modelos se puede ver en la tienda web)		

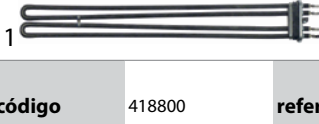

código	418800	referencia	12024577 12041359 P533001
descripción	resistencia 2x3000W 230V espirales 2 brida 70x18mm L 510mm An 60mm empalme M4 tubo ø 8mm brida de expansión		
Para modelos:	LA-25M, LA-AC-25M, LA-AC-25MA, LA-AC-25MP, LAC-25, LAC-25MP, LAC-25MPP, LAC-55, LAC-55MP, LAC-55MPP, LA-E-25M, LA-E-25MA, LA-E-25MP, LC-25, LC-E-25, LF-25MPP, LF-E-25, LF-E-25MP, LF-E-25MPP, LF-E-55, LF-E-55MP, LF-E-55MPP, LR-AC-25M, LR-AC-25MA, LR-AC-25MP, LR-E-25M, LR-E-25MA, LR-E-25MP		

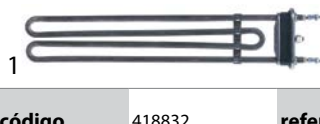

código	418832	referencia	12018752 P143002
descripción	resistencia 3000W 230V espirales 1 brida 70x18mm L 350mm An 63mm empalme M4 tubo ø 8mm resistencia de inmersión		
Para modelos:	LAC-10, LAC-10MP, LAC-10MPP, LC-10, LC-E-10, LC-E-10A, LF-E-10, LF-E-10A, LF-E-10MP, LF-E-10MPP		



código	418885	referencia	12023242 P633002
descripción	resistencia 4000W 230V espirales 1 brida 70x18mm L 350mm An 63mm H 18mm L1 23mm L2 19mm L3 308mm tubo ø 8mm empalme M4 resistencia de inmersión longitud de empalme 37mm brida de expansión EPDM		
Para modelos:	LA-18MP, LA-AC-18M, LA-AC-18MA, LA-AC-18MP, LA-E-18M, LA-E-18MA, LA-E-18MP, LF-18MPP, LR-AC-18M, LR-AC-18MA, LR-E-18M, LR-E-18MA, LR-E-18MP		





código	418529	referencia	12023778 Z743601
descripción	resistencia 4500W 230V espirales 3 brida 70x18mm L 365mm An 65mm H 27mm empalme conector Faston 3,3mm resistencia de inmersión brida de expansión tubo ø 6.7mm		
Para modelos:	AD-120, AD-120B, AD-120BBTDD-UK, AD-120C, AD-120CW, AD-120HY, AD-90, AD-90BA, AD-90BBT, AD-90BDD, AD-90DD, ADE-120, ADE-120B, ECO-120, ECO-120B, FI-100, FI-100AR, FI-100B, FI-100BBT-UK, FI-120, FI-120AR+DD, FI-120B, FI-120C, FI-120HY-CLINIC, FI-120W, FI-80, FI-80AR, FI-80BBT-UK, FI-80W, FI-E-100, MF-120		



otros







código	416386	referencia	12024146 Z728306
descripción	resistencia 12000W 230V montaje ø 60mm espirales 3 L 428mm An 45mm H 44mm ø casquillo portasondas 6.7mm longitud casquillo portasondas 250mm casquillo portasondas 1 casquillo termostato no ajustado tubo ø 6.3mm dist. del agujero 82mm agujero ø 7mm empalme M4 resistencia de inmersión brida 6 orificios		
Para modelos:	AD-120, AD-120B, AD-120C, AD-120HY, CO-110, CO-110B, CO-110BDD, CO-110DD, CO-170, CO-170B, CO-170BDD, CO-170DD, CO-170HRS, CO-170HRSDD, CO-170HRS-SOFT, CO-170-SOFT, CO-172, CO-172B, CO-172BDD, CO-172DD, ECO-120, ECO-120B, FI-120, FI-120AR+DD, FI-120B, FI-120C, FI-120HY-CLINIC, FI-120W, LABP-1200, MF-120		
repuestos para	416386		
	código	691033	referencia 12010051 Q307035
	junta tórica EPDM espesor 5.34mm int.ø 62.87mm UE 1 pzs		







			
código	416383	referencia	12017951 12024559 Z401711 Z401738
descripción	resistencia 2400W 230V espirales 1 montaje ø 42mm L 278mm An 39mm H 39mm dist. del agujero 64mm agujero ø 7mm empalme M4 resistencia de inmersión brida 5 orificios		
Para modelos:	AD-15, AD-15D, LVC-12, LVC-15, LVC-15D, LVC-21D, LVR-10, LVR-14, LVR-14D		
accesorios para	416383		
	código	505092	referencia
			12010062 12016701 Q307053 S312113
junta tórica EPDM espesor 5.34mm int.ø 43.82mm UE 1 pzs			

			
código	416375	referencia	12024907 Z421712
descripción	resistencia 2800W 230V espirales 1 montaje ø 42mm L 290mm An 37mm H 32mm tubo ø 8mm dist. del agujero 42mm agujero ø 7mm empalme M4 brida 5 orificios		
Para modelos:	AD-21, AD-21B, AD-21BDD, AD-21C, AD-21D, AD-21DD, AD-21W, LVC-15D, LVC-21, LVC-21B, LVC-21C, LVC-21D, LVC-21W		
accesorios para	416375		
	código	505092	referencia
			12010062 12016701 Q307053 S312113
junta tórica EPDM espesor 5.34mm int.ø 43.82mm UE 1 pzs			
	código	524478	referencia
			—
junta tórica Viton espesor 5.7mm int.ø 44.2mm UE 1 pzs			

			
código	416384	referencia	12024683 Z201706
descripción	resistencia 2800W 230V montaje ø 63mm espirales 1 L 427mm An 44mm H 43mm ø casquillo portasondas 6.5mm longitud casquillo portasondas 190mm casquillo portasondas 1 casquillo termostato no ajustado dist. del agujero 41mm agujero ø 7.5mm empalme M4 brida 3 orificios brida redonda		
Para modelos:	AD-48, AD-48B, AD-48BDD, AD-48C, AD-48D, AD-48DD, AD-48HY, EASY-500, EASY-500B, EASY-500DD, FI-30, FI-30AR, FI-30AR+DD, FI-30B, FI-48, FI-48AR, FI-48B, FI-48B-BT-UK, FI-48C, FI-48D, FI-48HY-CLINIC, FI-48W, FI-50, FI-64W		
accesorios para	416384		
	código	691033	referencia
			12010051 Q307035
junta tórica EPDM espesor 5.34mm int.ø 62.87mm UE 1 pzs			

			
código	416385	referencia	12024732 Z241701
descripción	resistencia 6000W 230V montaje ø 63mm espirales 3 L 420mm An 39mm H 49mm ø casquillo portasondas 6.3mm longitud casquillo portasondas 190mm casquillo portasondas 1 casquillo termostato no ajustado tubo ø 8mm dist. del agujero 41mm agujero ø 7mm empalme M4 resistencia de inmersión brida 6 orificios		
Para modelos:	AD-120BBTDD-UK, AD-45BBT, AD-64, AD-64B, AD-64BBT, AD-64BDD, AD-64BTDD, AD-64C, AD-64D, AD-64DD, AD-64HY, AD-72, AD-90, AD-90BA, AD-90BBT, AD-90BDD, AD-90DD, CO-110, CO-110B, CO-110BDD, CO-110DD, CO-112, CO-112B, CO-112BDD, CO-112DD, EASY-500HP, EASY-500HPWBDD, FI-100, FI-48D, FI-60DD, FI-64, FI-64AR, FI-64B, FI-64B-BT-UK, FI-64C, FI-64D, FI-64HY-CLINIC, FI-64W, FI-72, FI-72AR, FI-80, FI-80AR, FI-80BBT-UK, FI-80W, FI-900, LABP-800, MF-48, MF-64		
accesorios para	416385		
	código	691033	referencia
			12010051 Q307035
junta tórica EPDM espesor 5.34mm int.ø 62.87mm UE 1 pzs			



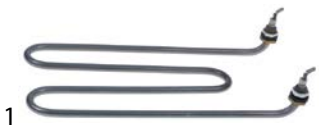

			
código	420326	referencia	12017495 Z691751
descripción	resistencia 9000W 220V montaje ø 63mm espirales 3 L 454mm An 48mm H 38mm ø casquillo portasondas 7mm longitud casquillo portasondas 180mm casquillo portasondas 1 casquillo termostato centrado, no ajustado tubo ø 8mm dist. del agujero 41mm agujero ø 7mm empalme M4 resistencia de inmersión brida 6 orificios		
Para modelos:	FI-1200, ME9-10BM, ME9-15BM		

			
código	416614	referencia	12023926 Z721701
descripción	resistencia 9600W 230V montaje ø 63mm espirales 3 L 425mm An 50mm H 45mm ø casquillo portasondas 6.5mm longitud casquillo portasondas 200mm casquillo portasondas 1 casquillo termostato descentrado, no ceñido tubo ø 6.5mm dist. del agujero 82mm agujero ø 7mm empalme M4 resistencia de inmersión brida 6 orificios		
Para modelos:	CO-142W, CO-142WDD, FI-100, FI-100AR, FI-100B, FI-100BBT-UK, FI-120, FI-80, FI-80W, FI-E-100, LABP-1000, ME9-10BM, ME9-10BMS, ME9-15BM, ME9-15BM316, ME9-15BMS, MPE9-10BM, MPE9-10BMS, MPE9-15BM, MPE9-15BMS		
repuestos para	416614		
	código	532163	referencia
			—
junta tórica EPDM espesor 5.34mm int.ø 62.87mm UE 10 pzs			
	código	691033	referencia
			12010051 Q307035
junta tórica EPDM espesor 5.34mm int.ø 62.87mm UE 1 pzs			

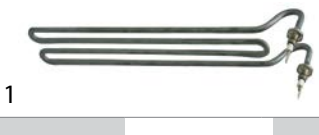

código	417222	referencia	12017628 Z603601
descripción	resistencia 2000W 230V espirales 1 L 280mm An 140mm H 23mm rosca 1/4" distancia de sujeción 132mm tubo ø 8mm empalme conector Faston 6,3mm resistencia de inmersión sujeción 2 orificios acero inoxidable		



código	416235	referencia	12030300 EU80677
descripción	resistencia 3000W 230V espirales 1 L 320mm An 50mm H 40mm rosca M10x1 distancia de sujeción 44mm tubo ø 6.3mm empalme conector Faston 6,3mm sujeción 2 orificios L1 32mm L2 288mm		
repuestos para	416235		
	código	referencia	—
	510893		
	junta tórica EPDM espesor 2.62mm int.ø 9.92mm UE 1 pzs		
accesorios para	416235		
	código	referencia	—
	510416		
	junta plana fibra ø ext. 19mm int.ø 10.5mm espesor 1.5mm para rosca M10 UE 1 pzs		
	código	referencia	—
	510893		
	junta tórica EPDM espesor 2.62mm int.ø 9.92mm UE 1 pzs		
	código	referencia	—
	521129		
	tuerca rosca M10 H 6mm inox EC 17 UE 1 pzs DIN/ISO DIN 439		
	código	referencia	—
	560192		
	arandela dentada int.ø 10.4mm ø ext. 18mm inox DIN/ISO DIN 6798A UE 1 pzs para rosca M10		

resistencias circulación de aire



código	417658	referencia	12031112 12043757 D01AC02257 D01AC02254 D01AC02257
descripción	resistencia 2000W 230V L 500mm An 86mm empalme conector Faston 6,3mm		
Para modelos:	SF-13, SF-8		

accesorios

tuercas hexagonales



código	550261	referencia	12016635 X163012 Z600603
descripción	tuerca rosca M14x1 H 4mm EC 19 inox UE 1 pzs		
Para modelos:	BG9-05, BG9-05I, BG9-10, BG9-10I, FE-710, FE-720, FE-920, FG-710, FG-720, FG-920, FI-300B, FI-300R, FI-650R, LVC-15, LVC-21, LVR-14, LVR-20, LVR-20B		



código	560131	referencia	12009839 Q162020
descripción	tuerca hexagonal rosca M4 H 3.2mm EC 7 inox DIN/ISO DIN 934 / ISO 4032/8673 UE 20 pzs		
Para modelos:	ACE-201, ACE-202, AD-120, AD-120B, AD-120BTTDD-UK, AD-120C, AD-120CW, AD-120HY, AD-15, AD-15D, AD-20C-UK, AD-21, AD-21B, AD-21BDD, AD-21C, AD-21D, AD-21DD, AD-21W, AD-45BBT, AD-48, AD-48B, AD-48BDD, AD-48C, AD-48D, AD-48DD, AD-48HY, AD-48W, AD-64, AD-64B, AD-64BBT, AD-64BDD, AD-64C, AD-64CW, AD-64D, AD-64DD, AD-64HY, AD-72, AD-72W, AD-90, AD-90BA, AD-90BBT, AD-90BDD, AD-90DD, ADE-120, ADE-120B, AE-061, AE-061W, AE-101, AE-101W, AE-102...(Otros modelos se puede ver en la tienda web)		



código	560132	referencia	12010194 12010284 Q162030 Q163030
descripción	tuerca hexagonal rosca M5 H 4mm EC 8 inox DIN/ISO DIN 934 / ISO 4032/8673 UE 20 pzs		
Para modelos:	ACE-061, ACE-101, ACE-102, ACE-201, ACE-202, ACG-061, ACG-101, ACG-102, ACG-201, ACG-202, AD-120, AD-120B, AD-120BTTDD-UK, AD-120C, AD-120CW, AD-120HY, AD-15, AD-15D, AD-20C-UK, AD-21, AD-21B, AD-21BDD, AD-21C, AD-21D, AD-21DD, AD-21W, AD-45BBT, AD-48, AD-48B, AD-48BDD, AD-48C, AD-48D, AD-48DD, AD-48HY, AD-48W, AD-64, AD-64B, AD-64BBT, AD-64BDD, AD-64BTTDD, AD-64C, AD-64CW, AD-64D, AD-64DD, AD-64HY, AD-72, AD-72W, AD-90, AD-90BA, AD-90BBT...(Otros modelos se puede ver en la tienda web)		



arandelas



1

código	560111	referencia	12009987 Q232020
descripción	arandela int.ø 4.3mm ø ext. 9mm espesor 0.8mm inox UE 20 pzs DIN 125A para rosca M4		
Para modelos:	ACE-061, ACE-101, ACE-102, ACE-201, ACE-202, ACG-061, ACG-101, ACG-102, ACG-201, ACG-202, AD-120, AD-120B, AD-120BTTDD-UK, AD-120C, AD-120CW, AD-120HY, AD-15, AD-15D, AD-21, AD-21B, AD-21BDD, AD-21C, AD-21D, AD-21DD, AD-21W, AD-48, AD-48B, AD-48C, AD-48D, AD-48DD, AD-64, AD-64B, AD-64BTTDD, AD-64C, AD-64D, AD-64DD, AD-72, AD-90, AD-90BA, AD-90BBT, AD-90BDD, AD-90DD, ADE-120, ADE-120B, AE-061, AE-061W, AE-101, AE-101W, AE-102, AE-102W...(Otros modelos se puede ver en la tienda web)		



2

código	560112	referencia	12009944 Q232030
descripción	arandela int.ø 5.3mm ø ext. 10mm espesor 1mm inox UE 20 pzs DIN 125A para rosca M5		
Para modelos:	ACE-061, ACE-101, ACE-102, ACE-201, ACE-202, ACG-061, ACG-101, ACG-102, ACG-201, ACG-202, AD-120, AD-120B, AD-120BTTDD-UK, AD-120C, AD-120CW, AD-120HY, AD-15, AD-15D, AD-20C-UK, AD-21, AD-21B, AD-21BDD, AD-21C, AD-21D, AD-21DD, AD-21W, AD-45BBT, AD-48, AD-48B, AD-48BDD, AD-48C, AD-48D, AD-48DD, AD-48HY, AD-48W, AD-64, AD-64B, AD-64BBT, AD-64BDD, AD-64BTTDD, AD-64C, AD-64CW, AD-64D, AD-64DD, AD-64HY, AD-72, AD-72W, AD-90, AD-90BA, AD-90BBT...(Otros modelos se puede ver en la tienda web)		



1

código	560113	referencia	12009868 12038251 Q232040 RT13060120
descripción	arandela int.ø 6.4mm ø ext. 12mm espesor 1.6mm inox UE 20 pzs DIN 125A para rosca M6		
Para modelos:	ACE-061, ACE-101, ACE-102, ACE-201, ACE-202, ACG-061, ACG-101, ACG-102, ACG-201, ACG-202, AD-120, AD-120B, AD-120BTTDD-UK, AD-120C, AD-120CW, AD-120HY, AD-15, AD-15D, AD-20C-UK, AD-21, AD-21B, AD-21BDD, AD-21C, AD-21D, AD-21DD, AD-21W, AD-45BBT, AD-48, AD-48B, AD-48BDD, AD-48C, AD-48D, AD-48DD, AD-48HY, AD-48W, AD-64, AD-64B, AD-64BBT, AD-64BDD, AD-64BTTDD, AD-64C, AD-64CW, AD-64D, AD-64DD, AD-64HY, AD-72, AD-72W, AD-90, AD-90BA, AD-90BBT...(Otros modelos se puede ver en la tienda web)		

arandelas dentadas



1

código	560125	referencia	12009928 Q242020
descripción	arandela dentada int.ø 4.2mm ø ext. 8mm inox DIN/ISO DIN 6798A UE 20 pzs para rosca M4		
Para modelos:	ACE-061, ACE-101, ACE-102, ACE-201, ACE-202, ACG-061, ACG-101, ACG-102, ACG-201, ACG-202, AD-120, AD-120B, AD-120BTTDD-UK, AD-120C, AD-120CW, AD-120HY, AD-15, AD-15D, AD-20C-UK, AD-21, AD-21B, AD-21BDD, AD-21C, AD-21D, AD-21DD, AD-21W, AD-45BBT, AD-48, AD-48B, AD-48BDD, AD-48C, AD-48D, AD-48DD, AD-48HY, AD-48W, AD-64, AD-64B, AD-64BDD, AD-64BTTDD, AD-64C, AD-64CW, AD-64D, AD-64DD, AD-64HY, AD-72, AD-72W, AD-90, AD-90BA, AD-90BBT, AD-90BDD...(Otros modelos se puede ver en la tienda web)		

anillos de junta

juntas de fibra

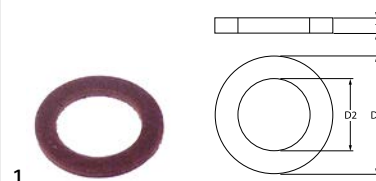

1

código	507332	referencia	12010260 Q306024
descripción	junta plana fibra ø ext. 18mm int.ø 12mm espesor 2mm UE 1 pzs		
Para modelos:	AD-120, AD-120B, AD-120BTTDD-UK, AD-120C, AD-120CW, AD-120HY, AD-45BBT, AD-48, AD-48B, AD-48BDD, AD-48C, AD-48D, AD-48DD, AD-48HY, AD-48W, AD-64, AD-64B, AD-64BBT, AD-64BDD, AD-64BTTDD, AD-64C, AD-64CW, AD-64D, AD-64DD, AD-64HY, AD-72, AD-72W, AD-90, AD-90BA, AD-90BBT, AD-90BDD, AD-90DD, ADE-120, ADE-120B, BME7-05, BME7-10, BME9-05, BME9-05AD, BME9-05PLUS, BME9-05V-T, BME9-10, BME9-10AD, BME9-10PLUS, BME9-10V-T, BMG7-10, BMG9-045, BMG9-05, BMG9-05V-T, BMG9-10, BMG9-10V-T...(Otros modelos se puede ver en la tienda web)		

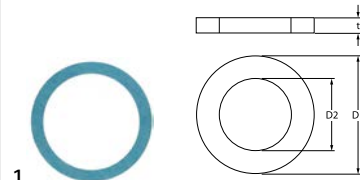

1

código	510406	referencia	12035981 ICR09387
descripción	junta plana fibra ø ext. 60mm int.ø 48mm espesor 3mm para rosca 1½" UE 1 pzs		

juntas tóricas			
código	505092	referencia	12010062 12016701 Q307053 S312113
descripción	junta tórica EPDM espesor 5.34mm int.ø 43.82mm UE 1 pzs		
Para modelos:	AD-15, AD-15D, AD-20C-UK, AD-21, AD-21B, AD-21BDD, AD-21C, AD-21D, AD-21DD, AD-21W, LVC-12, LVC-15, LVC-15D, LVC-21, LVC-21B, LVC-21C, LVC-21D, LVC-21W, LVR-10, LVR-14, LVR-14D, LVR-20, LVR-20B, LVR-20D, MF-21		

código	520357	referencia	12024282 Z101723
descripción	tapa de protección por brida ø 57,5mm ø 62mm H 42mm		
Para modelos:	AD-45BBT, AD-48, AD-48B, AD-48BDD, AD-48C, AD-48D, AD-48DD, AD-48HY, AD-48W, AD-64, AD-64B, AD-64BBT, AD-64BDD, AD-64BTDD, AD-64C, AD-64CW, AD-64D, AD-64DD, AD-64HY, AD-72, AD-72W, EASY-500, EASY-500B, EASY-500DD, EASY-500HP, EASY-500HPWBDD, ECO-160, ECO-1600, ECO-200, ECO-200H, ECO-2300, ECO-2700D, ECO-2700I, ECO-280D, ECO-280I, ECO-3000, ECO-370D, ECO-370I, ECO-4000D, ECO-4000I, ECO-460D, ECO-460I, ECO-550D, ECO-550I, ECO-6000D, ECO-6000I, FI-160, FI-1600, FI-160AR, FI-160D... (Otros modelos se puede ver en la tienda web)		

código	510408	referencia	12039760 eu456002 Q307020
descripción	junta tórica EPDM espesor 5.34mm int.ø 47mm UE 1 pzs		
Para modelos:	ECO-1200, FI-1200, FI-300B, FI-300R, FI-650R, FI-900		

código	505208	referencia	12022859 Z603602
descripción	soporte para resistencia		
Para modelos:	AD-15, AD-15D, AD-20C-UK, AD-21, AD-21B, AD-21BDD, AD-21C, AD-21D, AD-21DD, AD-21W, AD-45BBT, AD-48, AD-48B, AD-48BDD, AD-48C, AD-48D, AD-48DD, AD-48HY, AD-48W, AD-64, AD-64B, AD-64BBT, AD-64BDD, AD-64BTDD, AD-64C, AD-64CW, AD-64D, AD-64DD, AD-64HY, AD-72, AD-72W, BME7-05, BME7-10, BME9-05, BME9-05AD, BME9-05PLUS, BME9-05V-T, BME9-10, BME9-10AD, BME9-10PLUS, BME9-10V-T, EASY-500, EASY-500B, EASY-500DD, EASY-500HP, EASY-500HPWBDD, ECO-120, ECO-1200, ECO-120B, FI-100... (Otros modelos se puede ver en la tienda web)		

código	510409	referencia	12010040 Q307044
descripción	junta tórica EPDM espesor 5.34mm int.ø 56.52mm UE 1 pzs		
Para modelos:	ECO-160, ECO-1600, ECO-160D, ECO-160I, ECO-200, ECO-200D, ECO-200H, ECO-200HD, ECO-200HI, ECO-200I, ECO-2300, ECO-2700D, ECO-2700I, ECO-280D, ECO-280I, ECO-3000, ECO-370D, ECO-370I, ECO-4000D, ECO-4000I, ECO-460D, ECO-460I, ECO-550D, ECO-550I, ECO-6000D, ECO-6000I, FI-160, FI-1600, FI-160AR, FI-160D, FI-160I, FI-200, FI-200AR, FI-200D, FI-200H, FI-200HD, FI-200HI, FI-200I, FI-200W, FI-200WL, FI-200WR, FI-2300, FI-2700D, FI-2700I, FI-280D, FI-280I, FI-3000, FI-370D, FI-370I, FI-4000D... (Otros modelos se puede ver en la tienda web)		

termostatos

termostatos de superficie

termostatos de superficie de seguridad

código	390451	referencia	12025141 R213004
descripción	termómetro de superficie de seguridad dist. del agujeromm temp. desconexión 115°C 1NC 1 polos 16A empalme F6,3		
Para modelos:	AD-120, AD-120B, AD-120BBTDD-UK, AD-120C, AD-120CW, AD-120HY, AD-90, AD-90BA, AD-90BBT, AD-90BDD, AD-90DD, ADE-120, ADE-120B, BME7-05, BME7-10, BME9-05, BME9-10, ECO-120, ECO-120B, FI-100, FI-100AR, FI-100B, FI-100BBT-UK, FI-120, FI-120AR+DD, FI-120B, FI-120C, FI-120HY-CLINIC, FI-120W, FI-80, FI-80AR, FI-80BBT-UK, FI-80W, FI-E-100, LABP-1000, LABP-1200, MF-120		
accesorios para	390451		
	código	referencia	12024049 N503017
	junta para termostato ø ext. 35mm int.ø 24mm espesor 7mm núm. Ref. N503017		

tapas protectoras			
código	510034	referencia	12025258 Z401713
descripción	tapa de protección para resistencia ø 53mm distancia de sujeción 74mm plástico L 35mm		
Para modelos:	AD-15, AD-15D, AD-20C-UK, AD-21, AD-21B, AD-21BDD, AD-21C, AD-21D, AD-21DD, AD-21W, LVC-12, LVC-15, LVC-15D, LVC-21, LVC-21B, LVC-21C, LVC-21D, LVC-21W, LVR-10, LVR-14, LVR-14D, LVR-20, LVR-20B, LVR-20D, MF-21		



termostatos de superficie



código	391045	referencia	12095019
descripción	termostato de contacto dist. del agujero 23.5mm temp. desconexión 51°C 1NC 1 polos 10A empalme F6,3 roscada sonda ø 16mm		
Para modelos:	ACE-061, ACE-101, ACE-102, ACE-201, ACE-202, ACG-061, ACG-101, ACG-102, ACG-201, ACG-202, AE-061, AE-101, AE-102, AE-201, AE-202, AG-061, AG-101, AG-102, AG-201, AG-202, CO-350, CO-350-B, CO-350-B-DD, CO-350-COLD, CO-350-COLD-B, CO-350-COLD-B-DD, CO-350-COLD-DD, CO-350-DD, CO-400, CO-400-B, CO-400-B-DD, CO-400-COLD, CO-400-COLD-B, CO-400-COLD-B-DD, CO-400-COLD-DD, CO-400-DD, CO-400-SOFT		



código	390450	referencia	12023708 Z653013 Z718405
descripción	termostato de contacto dist. del agujeromm temp. desconexión 66/57°C NC/NO 2 polos 16A empalme F6,3		
Para modelos:	EASY-500, EASY-500B, EASY-500DD, EASY-500HP, EASY-500HPWBDD, ECO-120, ECO-1200, ECO-120B, FI-100, FI-100AR, FI-100B, FI-100BBT-UK, FI-120, FI-1200, FI-120AR+DD, FI-120B, FI-120C, FI-120HY-CLINIC, FI-120W, FI-30, FI-300B, FI-300R, FI-30AR, FI-30AR+DD, FI-30B, FI-30B-BT-UK, FI-30-UK, FI-48, FI-48B, FI-48B-BT-UK, FI-48D, FI-48W, FI-60DD, FI-64, FI-64AR, FI-64B, FI-64C, FI-64D, FI-64W, FI-650R, FI-72, FI-72AR, FI-80, FI-80AR, FI-80BBT-UK, FI-80W, FI-900, LABP-1000, LABP-1200, LABP-800...(Otros modelos se puede ver en la tienda web)		

accesorios para	390450			
	código	505093	referencia	12024049 N503017
	junta para termostato ø ext. 35mm int.ø 24mm espesor 7mm núm. Ref. N503017			



código	390428	referencia	12023814 P503025
descripción	termostato de contacto dist. del agujeromm temp. desconexión°C 1NO/1NC 2 polos 15A 250V empalme F6,3		
Para modelos:	LA-13M, LA-18MP, LA-25M, LA-AC-10M, LA-AC-10MA, LA-AC-10MP, LA-AC-13M, LA-AC-13MA, LA-AC-13MP, LA-AC-18M, LA-AC-18MA, LA-AC-18MP, LA-AC-25M, LA-AC-25MA, LA-AC-25MP, LAC-10MP, LAC-10MPP, LAC-14MP, LAC-14MPP, LAC-25MP, LAC-25MPP, LAC-55MP, LAC-55MPP, LAC-7MP, LAC-7MPP, LA-E-10M, LA-E-10MA, LA-E-10MP, LA-E-13M, LA-E-13MA, LA-E-13MP, LA-E-18M, LA-E-18MA, LA-E-18MP, LA-E-25M, LA-E-25MA, LA-E-25MP, LA-V-10M, LA-V-10MP, LA-V-13M, LA-V-13MP, LA-V-18M, LA-V-18MP, LA-V-25M, LA-V-25MP, LB-AC-10M, LB-E-10M, LB-V-10M, LF-13MPP, LF-18MPP...(Otros modelos se puede ver en la tienda web)		

accesorios para	390428			
	código	505093	referencia	12024049 N503017
	junta para termostato ø ext. 35mm int.ø 24mm espesor 7mm núm. Ref. N503017			

termostatos de control y seguridad

EGO

termostatos de regulación

serie 55.13_



código	375414	referencia	12024648 R343100
descripción	termóstato T máx 85°C margen de trabajo 30-85°C 1 polos 1CO 16A sonda ø 6mm sonda L 73mm capilar 1540mm aislamiento del capilar 1400mm prensaestopas M9x1 eje ø 6x4,6mm eje L 23mm posición del eje arriba ángulo de rotación 270°		
Para modelos:	FI-120W, FI-80W, HCV-10-11, HCV-10-21, HCV-2-10-21, HCV-6-11, HEI-10-21, HEM-10-11, HEM-20-11, HEM-6-11, HEP-10-11, HEP-20-11, HEP-6-11, HGV-10-11, HGV-20-11, HME-10-11, HME-10-21, HME-20-11, HME-2-10-11, HME-2-20-11, HME-6-11, HMM-10-11, HMM-10-11UL, HMM-10-21, HMM-10-21UL, HMM-20-11, HMM-20-11UL, HMM-20-21, HMM-20-21UL, HMM-2-10-11, HMM-40-11-USMC, HMM-6-11, HMM-6-11UL, HMP-10-11, HMP-10-21, HMP-20-11, HMP-2-10-11, HMP-2-10-11UL, HMP-6-11, HVG-10-11, HVG-10-11UL, HVG-10-21, HVG-10-21UL, HVG-20-11, HVG-20-21, HVG-2-10-11, HVG-2-20-21, MFHMM-20-11, MFHVG-10-11...(Otros modelos se puede ver en la tienda web)		



código	375400	referencia	12024096 Z393005
descripción	termóstato T máx 90°C margen de trabajo 30-90°C 1 polos 1CO 16A sonda ø 6mm sonda L 98mm capilar 2380mm aislamiento del capilar 1700mm prensaestopas M9x1 eje ø 6x4,6mm eje L 18mm posición del eje arriba ángulo de rotación 270°		
Para modelos:	AD-15, AD-15D, AD-20C-UK, AD-21, AD-21B, AD-21BDD, AD-21C, AD-21D, AD-21DD, AD-21W, AD-90, AD-90DD, FI-30, FI-30AR, FI-30AR+DD, FI-30B, FI-30B-BT-UK, FI-30-UK, FI-80, FI-80AR, FI-80W, LABP-800, LVC-12, LVC-15, LVC-15D, LVC-21, LVC-21B, LVC-21C, LVC-21D, LVC-21W, LVR-10, LVR-14, LVR-14D, LVR-20, LVR-20B, LVR-20D, MF-21		



código	375130	referencia	12024573 12030953 AL00000121 Z203014
descripción	termóstato T máx 90°C margen de trabajo 32-90°C 1 polos 1CO 16A sonda ø 6mm sonda L 129mm capilar 710mm aislamiento del capilar 500mm prensaestopas eje ø 6x4,6mm eje L 23mm posición del eje arriba ángulo de rotación 270°		
Para modelos:	AD-120, AD-120B, AD-120BBTDD-UK, AD-120C, AD-120CW, AD-120HY, AD-45BBT, AD-48, AD-48B, AD-48BDD, AD-48C, AD-48D, AD-48DD, AD-48HY, AD-48W, AD-64, AD-64B, AD-64BBT, AD-64BDD, AD-64C, AD-64CW, AD-64D, AD-64DD, AD-64HY, AD-72, AD-72W, AD-90, AD-90BA, AD-90BBT, AD-90BDD, AD-90DD, ADE-120, ADE-120B, BME6-05, BME7-05, BME7-10, BME9-05, BME9-05AD, BME9-05PLUS, BME9-05V-T, BME9-10, BME9-10AD, BME9-10PLUS, BME9-10V-T, ECO-120, ECO-120B, ECO-160, ECO-1600, ECO-160D, ECO-160L...(Otros modelos se puede ver en la tienda web)		

<p>TECASA</p> <p>termostatos de seguridad</p>			
código	376078	referencia	12038157 12135898 DO1DG11154
descripción	termóstato temp. desconexión 180°C 2 polos 16A sonda ø 6mm sonda L 59mm capilar 2000mm aislamiento del capilar mm eje ømm 240V		
Para modelos:	SF-13, SF-8, SR-10MP-PSM, SR-13MP-PSM, SR-32MP-PSM		

código	390452	referencia	12023830 R34312400 Z213014
descripción	termóstato de seguridad temp. desconexión 125°C 1 polos 16A sonda ø 6mm sonda L 73mm capilar 870mm aislamiento del capilar 690mm prensaestopas M9x1 bulbo inox		
Para modelos:	AD-120, AD-120B, AD-120BBTDD-UK, AD-120C, AD-120CW, AD-120HY, AD-125, AD-125HRS, AD-125-SOFT, AD-21W, AD-45BBT, AD-48, AD-48B, AD-48BDD, AD-48C, AD-48D, AD-48DD, AD-48HY, AD-48W, AD-505, AD-505-SOFT, AD-64, AD-64B, AD-64BBT, AD-64BDD, AD-64BTDD, AD-64C, AD-64CW, AD-64D, AD-64DD, AD-64HY, AD-72, AD-72W, AD-90, AD-90BA, AD-90BBT, AD-90BDD, AD-90DD, BME6-05, BME7-05, BME7-10, BME9-05, BME9-05AD, BME9-05PLUS, BME9-05V-T, BME9-10, BME9-10AD, BME9-10PLUS, BME9-10V-T, CO-110...(Otros modelos se puede ver en la tienda web)		

<p>accesorios</p> <p>casquillos de inmersión</p>			
código	505207	referencia	12022418 Z263002
descripción	casquillo de inmersión rosca M12x1,75 H M M12x1,75 int.ø 8mm L 95mm inox / latón simple ø 10mm		
Para modelos:	ECO-120, ECO-1200, ECO-120B, ECO-160, ECO-160D, ECO-160L, ECO-200, ECO-200D, ECO-200H, ECO-200HD, ECO-200HI, ECO-200I, ECO-2700D, ECO-2700I, ECO-280D, ECO-280I, ECO-370D, ECO-370I, ECO-4000D, ECO-4000I, ECO-460D, ECO-460I, ECO-550D, ECO-550I, ECO-6000D, ECO-6000I, FI-100, FI-100AR, FI-100B, FI-100BBT-UK, FI-120, FI-1200, FI-120AR+DD, FI-120B, FI-120C, FI-120HY-CLINIC, FI-120W, FI-160, FI-160AR, FI-160D, FI-160I, FI-200, FI-200AR, FI-200D, FI-200H, FI-200HD, FI-200HI, FI-200I, FI-200W, FI-200WL...(Otros modelos se puede ver en la tienda web)		

<p>interruptores y pulsadores</p> <p>interruptores/pulsadores basculantes</p>			
<p>28x13,5mm</p>			
código	347873	referencia	12024372 Z20307
descripción	pulsador basculante medida de montaje 27,4x12,4mm negro 1NO 250V 16A empalme conector Faston 6,3mm temperatura ambiente máx. 85°C protección IP40		
Para modelos:	FI-48D, FI-64D, LVC-15, LVC-15D, LVC-21, LVC-21D		

<p>30x11mm</p>			
código	345489	referencia	12023616 Z403033
descripción	pulsador basculante medida de montaje 30x11mm naranja 1NO 250V 16A empalme conector Faston 6,3mm temperatura ambiente máx. 90°C protección IP40		
Para modelos:	FI-48, FI-48AR, FI-48B, FI-48B-BT-UK, FI-48C, FI-48D, FI-48HY-CLINIC, FI-48W, FI-64, FI-64AR, FI-64B, FI-64B-BT-UK, FI-64C, FI-64D, FI-64HY-CLINIC, FI-64W, LVC-12, LVC-15, LVC-15D, LVC-21, LVC-21B, LVC-21C, LVC-21D, LVC-21W, LVR-14, LVR-14D, LVR-20, LVR-20D		

30x22mm



1

código	301002	referencia	12024356 12035989 12036781 12037293 6001507003 6021130001 Z203003 Z203033 ZAINTE0009
descripción	interruptor basculante medida de montaje 30x22mm naranja 2NO 250V 16A iluminado 0-I empalme conector Faston 6,3mm temperatura ambiente máx. 85/125°C protección IP65		
Para modelos:	AC-120, AC-180, AEP-1402, AEP-1403, AEP-1404, AEP-1602, AEP-1603, AEP-1604, AEP-2103, AEP-701, AEP-702, AEP-801, AEP-802, AF-1402-MIX, AF-1403-C, AF-1403-P, AF-1404-C, AF-1404-P, AF-1602-MIX, AF-1603-C, AF-1603-P, AF-1604-C, AF-1604-P, AF-2104-C, AF-2104-P, AF-2105-C, AF-2105-P, AF-2106-C, AF-2106-P, AF-702-C, AF-702-P, AF-802-C, AF-802-P, AFN-1402, AFN-1403, AFN-1404, AFN-1602, AFN-1603, AFN-1604, AFN-701, AFN-702, AFN-801, AFN-802, AFP-1402, AFP-1402-FORZ, AFP-1402-MIX, AFP-1403, AFP-1403-C, AFP-1403-FORZ, AFP-1403-P...(Otros modelos se puede ver en la tienda web)		
accesorios para	301002		
	código	301036	referencia —
	cubierta protectora dimensión interior 30x22mm para interruptor basculante medida de montaje mm		



1

código	345491	referencia	12039115 Z213001 Z213033
descripción	pulsador basculante medida de montaje 30x22mm naranja 1NO/lámpara 250V 16A empalme conector Faston 6,3mm temperatura ambiente máx. 100/55°C protección IP40		
Para modelos:	EASY-500, EASY-500B, EASY-500DD, EASY-500HP, EASY-500HPWBDD, FI-48, FI-48AR, FI-48B, FI-48B-BT-UK, FI-48C, FI-48D, FI-48HY-CLINIC, FI-48W, FI-64, FI-64AR, FI-64B, FI-64B-BT-UK, FI-64C, FI-64D, FI-64HY-CLINIC, FI-64W, FI-72, GA-20, GA-20D, GA-40, GA-40D, HCG-10-11, HCG-10-21, HCG-20-11, HCG-20-21, HCG-2-10-11, HCG-2-20-11, HCG-6-11, HCG-10-11, HCG-20-11, HCG-6-11, HGV-10-11, HGV-20-11, HVG-10-11, HVG-10-11UL, HVG-10-21, HVG-10-21UL, HVG-20-11, HVG-20-21, HVG-2-10-11, HVG-2-20-21, LAC-10MP, LAC-10MPP, LAC-14MP, LAC-14MPP...(Otros modelos se puede ver en la tienda web)		
accesorios para	345491		
	código	301036	referencia —
	cubierta protectora dimensión interior 30x22mm para interruptor basculante medida de montaje mm		



1

código	301061	referencia	12025209 Z203071
descripción	interruptor basculante medida de montaje 30x22mm naranja 2NO 250V 16A iluminado empalme conector Faston 6,3mm temperatura ambiente máx. 125/55°C protección IP40		
Para modelos:	FI-30, FI-30AR, FI-30AR+DD, FI-30-UK, FI-60DD, LVC-12, LVC-15, LVC-21		



1

código	346689	referencia	12024213 Z203080
descripción	pulsador basculante medida de montaje 30x22mm naranja 1NO/lámpara 230V 16A iluminado empalme conector Faston 6,3mm temperatura ambiente máx. 125°C protección IP40		
Para modelos:	FI-48, FI-48AR, FI-48B, FI-48B-BT-UK, FI-48C, FI-48D, FI-48HY-CLINIC, FI-48W, FI-64, FI-64AR, FI-64B, FI-64B-BT-UK, FI-64C, FI-64D, FI-64HY-CLINIC, FI-64W, FI-72, FI-72AR, FI-72W, GA-20, GA-40, LVC-15, LVC-15D, LVC-21, LVC-21B, LVC-21C, LVC-21D, LVC-21W		

interruptores pulsantes y pulsadores

30x22mm



1

código	301047 ¹	referencia	12024373 Z853001
descripción	interruptor pulsante medida de montaje 30x22mm verde 2NO 250V 16A iluminado empalme conector Faston 6,3mm temperatura ambiente máx. 85°C protección IP40 con enclavamiento		
Para modelos:	FE-18, FE-25, FE-4, FE-6, FE-71-15, FE-8, FE-91-20, FI-300R, FI-650R, HCV-10-11, HCV-10-21, HCV-2-10-21		

¹iluminado

ø22mm



1

código	348220	referencia	12115383
descripción	pulsador montaje ø22mm plata 1NO/1NC/lámpara 220V 5A empalme conector Faston 2,8mm redondo		
Para modelos:	CO-350, CO-350-B, CO-350-B-DD, CO-350-COLD, CO-350-COLD-B, CO-350-COLD-B-DD, CO-350-COLD-DD, CO-350-DD, CO-400, CO-400-B, CO-400-B-DD, CO-400-COLD, CO-400-COLD-B, CO-400-COLD-B-DD, CO-400-COLD-DD, CO-400-DD, CO-400-SOFT, CO-500, CO-500B, CO-500BDD, CO-500DD, CO-501, CO-501B, CO-501BDD, CO-501DD, CO-501-SOFT		

ø25mm



1

código	345039	referencia	12036803 FX40100036
descripción	cubierta protectora redondo ø ext. 33mm dimensiones exteriores 23mm dimensión interior 21mm H 12mm claro montaje ø25mm		
accesorios para	345039		
	código	345001	referencia —
	pulsador montaje ø25mm amarillo 1NO/lámpara 250V 16A cubierta empalme conector Faston 6,3mm temperatura ambiente máx. 85°C protección IP65		

microinterruptores

accionado por palanca



1

código	345254	referencia	12033747 GMP831613
descripción	microinterruptor con manilla 250V 16A 1CO empalme conector Faston 6,3mm temperatura ambiente máx. 120°C distancia de sujeción 22mm fuerza de accionamiento: 60g longitud de palanca 58mm		

accionados por pistón



1

código	345105	referencia	12037903 BR00023055
descripción	microinterruptor con varilla 250V 16A 1CO empalme conector Faston 6,3mm L 28mm temperatura ambiente máx. 125°C distancia de sujeción 22mm tipo SM-51 fuerza de accionamiento: 280g negro		

M10



1

código	345032	referencia	12040850 GMP831318
descripción	microinterruptor con varilla rosca M10x1 rosca L 12mm 250V 16A 1CO empalme conector Faston 6,3mm carrera 7mm distancia de sujeción 22mm L 28mm temperatura ambiente máx. 125°C tipo SP9603 fuerza de accionamiento: 180g		
Para modelos:	FE-18, FE-25, FE-4, FE-6, FE-8, SBE7-10, SBE9-10, SBE9-10I, SBE9-10IM, SBE9-10IMS, SBE9-10IS, SBE9-10M, SBE9-10MS, SBE9-10PLUS-I, SBE9-10PLUS-IM, SBE9-10PLUS-SI, SBE9-10PLUS-SIM, SBE9-10S, SBE9-15IM, SBE9-15IMS, SBE9-15M, SBE9-15MS, SBE9-15PLUS-IM, SBE9-15PLUS-SIM, SBG7-10, SBG9-10, SBG9-10I, SBG9-10IM, SBG9-10IMS, SBG9-10IS, SBG9-10M, SBG9-10MS, SBG9-10PLUS-I, SBG9-10PLUS-IM, SBG9-10PLUS-SI, SBG9-10PLUS-SIM, SBG9-10S, SBG9-15IM, SBG9-15IMS, SBG9-15PLUS-IM, SBG9-15PLUS-SIM		

accesorios



1

código	505166	referencia	Z653010
descripción	accionador para microinterruptor		
Para modelos:	FI-300B, FI-300R, FI-650R		

interruptores de sistema ROLD



1

código	345650	referencia	12024804 X022109
descripción	unidad de pulsador 2CO 250V 16A empalme conector Faston 6,3mm		
Para modelos:	SBE9-10, SBE9-10I, SBE9-10IM, SBE9-10IM-AD, SBE9-10IM-AD-S, SBE9-10IMS, SBE9-10IS, SBE9-10M, SBE9-10MS, SBE9-10PLUS-IM, SBE9-10PLUS-SIM, SBE9-10S, SBE9-15IM, SBE9-15IM-AD, SBE9-15IM-AD-S, SBE9-15IMS, SBE9-15M, SBE9-15MS, SBE9-15PLUS-IM, SBE9-15PLUS-SIM, SBG9-10IM, SBG9-10IM-AD, SBG9-10IM-AD-S, SBG9-10IMS, SBG9-10M, SBG9-10MS, SBG9-10PLUS-IM, SBG9-10PLUS-SIM, SBG9-15IM, SBG9-15IM-AD, SBG9-15IM-AD-S, SBG9-15IMS, SBG9-15PLUS-IM, SBG9-15PLUS-SIM		

conmutadores de levas

3 posiciones de conmutación



1

código	345492	referencia	12025105 Z213003
descripción	conmutador de levas 3-posiciones de conmutación 3NO secuencia de conmutación 1-0-2 16A eje ø 6x4,6mm eje L 23mm empalme conector Faston 6,3mm		
Para modelos:	FI-48, FI-48B, FI-48W, FI-64, FI-64W, FI-72, FI-72AR, FI-72W		

4 posiciones de conmutación



1

código	347386	referencia	12024733 Z273005
descripción	conmutador de levas 4 posiciones de control 6NO secuencia de conmutación 0-1-2-3 16A eje ø 6x4,6mm eje L 23mm empalme conector Faston 6,3mm 7LA 840601		
Para modelos:	ECO-160, ECO-160D, ECO-160I, ECO-200, ECO-200D, ECO-200H, ECO-200HD, ECO-200HI, ECO-200I, ECO-2700D, ECO-2700I, ECO-280D, ECO-280I, ECO-370D, ECO-370I, ECO-4000D, ECO-4000I, ECO-460D, ECO-460I, ECO-550D, ECO-550I, ECO-6000D, ECO-6000I, FI-160, FI-160AR, FI-160D, FI-160I, FI-200, FI-200AR, FI-200D, FI-200H, FI-200HD, FI-200HI, FI-200I, FI-200W, FI-200WL, FI-200WR, FI-2700D, FI-2700I, FI-280D, FI-280I, FI-370D, FI-370I, FI-4000D, FI-4000I, FI-460D, FI-460I, FI-550D, FI-550I, FI-6000D...(Otros modelos se puede ver en la tienda web)		



1

código	347817	referencia	12024445
descripción	conmutador de levas 4 posiciones de control 8NO secuencia de conmutación 1-0-2-3 16A eje ø 6x4,6mm eje L 23mm empalme conector Faston 6,3mm plástico		
Para modelos:	CO-500, CO-500B, CO-500BDD, CO-500DD, CO-501, CO-501B, CO-501BDD, CO-501DD, CO-501-SOFT, EASY-500, EASY-500B, EASY-500DD, EASY-500HP, EASY-500HPWBDD		



1

código	348225	referencia	12024972 new version
descripción	conmutador de levas 4 posiciones de control secuencia de conmutación 1-0-2-3 a impulso 16A(4)A eje ø 6x4,6mm eje L 23mm empalme conector Faston 6,3mm plástico		

6 posiciones de conmutación



1

código	347578	referencia	12024290 Z683085
descripción	conmutador de levas 6 posiciones de conmutación 7NO secuencia de conmutación 0-1-2-3-4-5 16A eje ø 6x4,6mm eje L 23mm empalme conector Faston 6,3mm plástico		
Para modelos:	ECO-120, ECO-120B, FI-100, FI-100AR, FI-100B, FI-120, FI-1200, FI-120AR+DD, FI-120B, FI-120W, FI-900, LABP-1000, LABP-1200, MF-120		

7 posiciones de conmutación

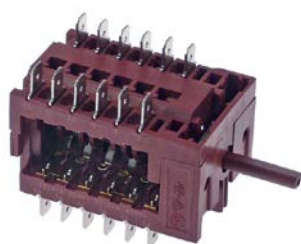

1

código	301298	referencia	12024932 Z713097
descripción	conmutador de levas 7 posiciones de conmutación 12NO secuencia de conmutación 0-1-2-3-4-5-6 16A eje ø 6x4,6mm eje L 23mm empalme conector Faston 6,3mm plástico 12 polos		
Para modelos:	CO-110, CO-110B, CO-110BDD, CO-110DD, CO-170, CO-170B, CO-170BDD, CO-170DD, CO-170HRS, CO-170HRSDD, CO-170HRS-SOFT, CO-170-SOFT, ECO-120B, FI-100B, FI-100BBT-UK, FI-120B, FI-120C, FI-120HY-CLINIC		

conmutadores giratorios

GOTTAK

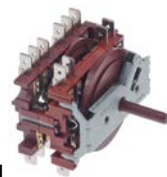

1

código	347874	referencia	12023965 Z743019
descripción	conmutador giratorio 5 0-1-2-3-4 juegos de contactos 10 tipo 46RCTH 400V 16A eje ø 6x4,6mm eje L 23mm eje 6x4,6 empalme conector Faston 6,3mm		
Para modelos:	FI-80BBT-UK		

interruptores magnéticos

32x15mm



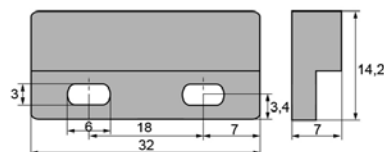

1

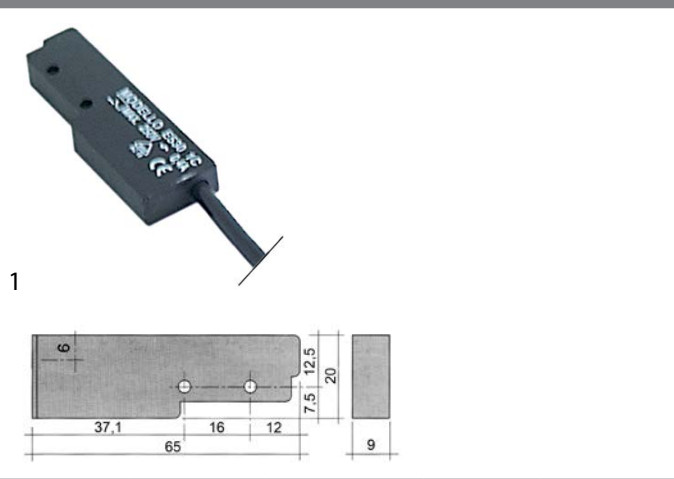

código	345109	referencia	12034091 RT30161415
descripción	interruptor magnético L 32mm An 15mm 1NO 250V 1A P máx. 40W empalme cable longitud del cable 2000mm		

65x20mm



código	345116	referencia	12024560 Z100522
descripción	interruptor magnético L 65mm An 20mm 1NO 250V 0.4A P máx. 100W empalme cable longitud del cable 3000mm		
Para modelos:	ACE-061, ACE-101, ACE-102, ACE-201, ACE-202, ACG-061, ACG-101, ACG-102, ACG-201, ACG-202, AE-061, AE-061W, AE-101, AE-101W, AE-102, AE-102W, AE-201, AE-202, AG-061, AG-061W, AG-101, AG-101W, AG-102, AG-102W, AG-201, AG-202, APE-061, APE-061W, APE-101, APE-101W, APE-102, APE-102W, APE-201, APE-202, APG-061, APG-061W, APG-101, APG-101W, APG-102, APG-102W, APG-201, APG-202, COE-061, COE-101, COE-102, COE-201, COE-202, COG-061, COG-101, COG-102...(Otros modelos se puede ver en la tienda web)		
accesorios para	345116		
		código	345399
		referencia	—
	imán ø 3.3mm L 40mm H 8mm An 13mm dist. del agujero 30mm M3		

ø 6mm



código	345202	referencia	12024477 Z203009
descripción	interruptor magnético 250V 0.04A P máx. 10W sonda L 29mm 1NO empalme conector longitud del cable 1400mm		
Para modelos:	AD-120, AD-120B, AD-120BBTDD-UK, AD-120C, AD-120CW, AD-120HY, AD-125, AD-125HRS, AD-125-SOFT, AD-15, AD-15D, AD-20C-UK, AD-21, AD-21B, AD-21BDD, AD-21C, AD-21D, AD-21DD, AD-21W, AD-45BBT, AD-48, AD-48B, AD-48BDD, AD-48C, AD-48D, AD-48DD, AD-48HY, AD-48W, AD-505, AD-505-SOFT, AD-64, AD-64B, AD-64BBT, AD-64BDD, AD-64BTDD, AD-64C, AD-64CW, AD-64D, AD-64DD, AD-64HY, AD-72, AD-72W, AD-90, AD-90BA, AD-90BBT, AD-90BDD, AD-90DD, ADE-120, ADE-120B, ATA-061...(Otros modelos se puede ver en la tienda web)		

accesorios

imanes



1

código	347093	referencia	12024499 Z271207
descripción	imán ø 31mm Lmm H 15mm Anmm M5		
Para modelos:	ECO-160, ECO-160D, ECO-160I, ECO-200, ECO-200D, ECO-200H, ECO-200HD, ECO-200HI, ECO-200I, ECO-280D, ECO-280I, ECO-370D, ECO-370I, ECO-460D, ECO-460I, ECO-550D, ECO-550I, FI-160, FI-160AR, FI-160D, FI-160I, FI-200, FI-200AR, FI-200D, FI-200H, FI-200HD, FI-200HI, FI-200I, FI-200W, FI-200WL, FI-200WR, FI-280D, FI-280I, FI-370D, FI-370I, FI-460D, FI-460I, FI-550D, FI-550I		



1

código	505004	referencia	12024303 Z200506
descripción	imán ømm L 17mm H 12mm An 14mm		
Para modelos:	ACE-061, ACE-101, ACE-102, ACG-061, ACG-101, ACG-102, AD-120, AD-120B, AD-120BBTDD-UK, AD-120C, AD-120CW, AD-120HY, AD-15, AD-15D, AD-20C-UK, AD-21, AD-21B, AD-21BDD, AD-21C, AD-21D, AD-21DD, AD-21W, AD-45BBT, AD-48, AD-48B, AD-48BDD, AD-48C, AD-48D, AD-48DD, AD-48HY, AD-48W, AD-64, AD-64B, AD-64BBT, AD-64BDD, AD-64BTDD, AD-64C, AD-64CW, AD-64D, AD-64DD, AD-64HY, AD-72, AD-72W, AD-90, AD-90BA, AD-90BBT, AD-90BDD, AD-90DD, ADE-120, ADE-120B...(Otros modelos se puede ver en la tienda web)		

soporte magnético



1

código	700816	referencia	12024094 Z200507
descripción	tapa de protección para magnético dimensión interior 14x17mm H 17mm para lavavajillas		
Para modelos:	AD-120, AD-120B, AD-120BBTDD-UK, AD-120C, AD-120CW, AD-120HY, AD-15, AD-15D, AD-20C-UK, AD-21, AD-21B, AD-21BDD, AD-21C, AD-21D, AD-21DD, AD-21W, AD-45BBT, AD-48, AD-48B, AD-48BDD, AD-48C, AD-48D, AD-48DD, AD-48HY, AD-48W, AD-64, AD-64B, AD-64BBT, AD-64BDD, AD-64BTDD, AD-64C, AD-64CW, AD-64D, AD-64DD, AD-64HY, AD-72, AD-72W, AD-90, AD-90BA, AD-90BBT, AD-90BDD, AD-90DD, ADE-120, ADE-120B, COE-061, COE-101, COE-102, COG-061, COG-101, COG-102...(Otros modelos se puede ver en la tienda web)		



aparatos de mando y aviso

TELEMECANIQUE (EFA)

serie XB2

selectores giratorios



1

código	345222	referencia	12024490 Z103044
descripción	selector giratorio medida de montaje ø22mm negro con enclavamiento secuencia de conmutación 0-1		
Para modelos:	ECO-1600, ECO-2300, ECO-3000, FI-1600, FI-2300, FI-3000		

lámparas



1

código	359807	referencia	12039863 Z103056
descripción	bombilla incandescente casquillo Ba9s 24V 2W ø 10mm L 28mm claro		
Para modelos:	ECO-1600, ECO-2300, ECO-3000, FI-1600, FI-2300, FI-3000		

lámparas

lámparas de señalización

lámparas de señalización 3 piezas (casquillo, lente y bombilla)

lámparas

bombillas incandescentes



1

código	359807	referencia	12039863 Z103056
descripción	bombilla incandescente casquillo Ba9s 24V 2W ø 10mm L 28mm claro		
Para modelos:	ECO-1600, ECO-2300, ECO-3000, FI-1600, FI-2300, FI-3000		

lámparas de señalización completas

ø 9mm



1

código	359137	referencia	12024344
descripción	lámpara de señalización ø 9mm 230V amarillo empalme conector Faston 6,3mm resis.a la temp. 120°C con lente		
Para modelos:	ECO-120, ECO-120B, FI-100, FI-100AR, FI-100B, FI-100BBT-UK, FI-120, FI-120AR+DD, FI-120B, FI-120C, FI-120HY-CLINIC, FI-120W, FI-80, FI-80AR, FI-80BBT-UK, FI-80W, GA-20, GA-20D, GA-40, GA-40D		

ø12mm

con casquillo roscado



1

código	359048	referencia	12035239 ICR13205
descripción	lámpara de señalización ø 12mm 230V amarillo empalme conector Faston 6,3mm		



1

código	359027	referencia	12025211 12036324 DO1DL14313 R693055
descripción	lámpara de señalización ø 12mm 250V verde empalme conector Faston 6,3mm		
Para modelos:	BME6-05, BME7-05, BME7-10, BME9-05, BME9-05AD, BME9-05PLUS, BME9-05V-T, BME9-10, BME9-10AD, BME9-10PLUS, BME9-10V-T, CE6-41, CE7-41, CE7-41Q, CE9-41, CGE6-41, CGE7-41, CGE7-41H, CGE9-11, CGE9-41, CGE9-41AD, CGE9-41PLUS, CMF6-05, CPE6-05, CPE7-05, CPE7-05NC, CPE9-05, CPE9-05AD, CPE9-05AD-S, CPE9-05NC, CPE9-05PLUS, CPE9-05PLUS-S, CPE9-05S, CPE9-05SNC, EASY-500, EASY-500B, EASY-500DD, EASY-500HP, EASY-500HPWBDD, EPC-350, FE-18, FE-25, FE-4, FE-6, FE6-05, FE6-05TE, FE6-10, FE6-10TE, FE7-05-1C, FE7-05-2C...(Otros modelos se puede ver en la tienda web)		

con casquillo enchufable



1

código	359493	referencia	12023599 X143017
descripción	lámpara de señalización ø 12mm 250V verde empalme conector Faston 6,3mm resis.a la temp. 120°C		
Para modelos:	CE9-41AD, CE9-41PLUS, ME7-10BM, SBE7-10, SBE9-10, SBE9-10I, SBE9-10I-AD, SBE9-10I-AD-S, SBE9-10IM, SBE9-10IM-AD, SBE9-10IM-AD-S, SBE9-10IMS, SBE9-10IS, SBE9-10M, SBE9-10MS, SBE9-10PLUS-I, SBE9-10PLUS-IM, SBE9-10S, SBE9-10USMC, SBE9-15IM, SBE9-15IM-AD, SBE9-15IM-AD-S, SBE9-15IMS, SBE9-15M, SBE9-15MS, SBE9-15PLUS-IM, SBG7-10, SBG9-10, SBG9-10I, SBG9-10I-AD, SBG9-10I-AD-S, SBG9-10IM, SBG9-10IM-AD, SBG9-10IM-AD-S, SBG9-10IMS, SBG9-10IS, SBG9-10M, SBG9-10MS, SBG9-10PLUS-I, SBG9-10PLUS-IM, SBG9-10PLUS-SI, SBG9-10PLUS-SIM, SBG9-10S, SBG9-15IM, SBG9-15IM-AD, SBG9-15IM-AD-S, SBG9-15IMS, SBG9-15PLUS-IM, SBG9-15PLUS-SIM		

ø14mm

con casquillo enchufable



1

código	359149	referencia	12039886 R343125
descripción	lámpara de señalización ø 14mm amarillo 230V empalme conector Faston 6,3mm resis.a la temp. 105°C		
Para modelos:	CE-410, FE-18, FE-25, FE-4, FE-6, FE-8, FE-91-20, HCV-10-11, HCV-10-21, HCV-2-10-21, HE-10-11, HE-10-21, HE-2-10-11, HE-6-11, HG-10-21, HG-2-10-11		



1

código	359148	referencia	12021153 12039891 R343123 U183044
descripción	lámpara de señalización ø 14mm verde 230V empalme conector Faston 6,3mm resis.a la temp. 120°C tensión AC		
Para modelos:	CE-410, FE-18, FE-25, FE-4, FE-6, FE-8, FE-91-20, HCV-10-11, HCV-10-21, HCV-2-10-21, HE-10-11, HE-10-21, HE-2-10-11, HE-6-11, HG-10-21, HG-2-10-11		

lámpade

bombillas incandescentes

para lámparas de señalización



1

código	359807	referencia	12039863 Z103056
descripción	bombilla incandescente casquillo Ba9s 24V 2W ø 10mm L 28mm claro		
Para modelos:	ECO-1600, ECO-2300, ECO-3000, FI-1600, FI-2300, FI-3000		

temporizadores

temporizadores de programa

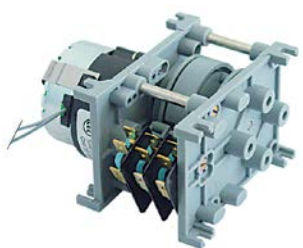

1

código	361350	referencia	12024867 Z613003
descripción	temporizador 4803F1 motores 1 cámaras 3 tiempo de funcionamiento 20min aliment. 230V eje ømm eje Lmm		
Para modelos:	CO-170-SOFT, CO-400-SOFT, CO-501-SOFT, FI-48, FI-48AR, FI-48B, FI-48B-BT-UK, FI-48C, FI-48D, FI-48HY-CLINIC, FI-48W, FI-64, FI-64AR, FI-64B, FI-64B-BT-UK, FI-64C, FI-64D, FI-64HY-CLINIC, FI-64W, LVC-15D, LVC-21D, LVR-14D, LVR-20D		



1

código	361358	referencia	12017510 Z728302
descripción	temporizador CDC 4905DV motores 2 cámaras 5 tiempo de funcionamiento 6s / 2min aliment. 230V 60Hz eje ømm eje Lmm tipo de motor M48R ATS / M48L ATS		
Para modelos:	ECO-120, ECO-120B, FI-100, FI-100AR, FI-100B, FI-120, FI-120B, FI-120W, MF-120		



1

código	360683	referencia	12024571 Z713055
descripción	temporizador CDC 4905DV motores 2 cámaras 5 tiempo de funcionamiento 6s / 2min aliment. 230V eje ømm eje Lmm		
Para modelos:	FI-100, FI-100AR, FI-100B, FI-120, FI-120AR+DD, FI-120B, FI-120C, LABP-1000, LABP-1200		



1

código	360696	referencia	12023458
descripción	temporizador CDC 4906DV motores 2 cámaras 6 tiempo de funcionamiento 6s / 2min aliment. 230V 50Hz eje ømm eje Lmm N° fabricante 4906DV0A0E000.1010		



1

código	360441	referencia	12023466 Z728412
descripción	temporizador CDC 4906DV motores 2 cámaras 6 tiempo de funcionamiento 6s / 2min aliment. 230V 60Hz eje ømm eje Lmm N° fabricante 4906DV0ADY000.0000		
Para modelos:	FI-120W, MF-120		



1

código	361357	referencia	12024873 Z433002
descripción	temporizador CDC 7803 motores 1 cámaras 3 tiempo de funcionamiento 120s aliment. 230V eje ømm eje Lmm tipo de motor M37LN		
Para modelos:	CO-350, CO-350-B, CO-350-B-DD, CO-350-COLD, CO-350-COLD-B, CO-350-COLD-B-DD, CO-350-COLD-DD, CO-350-DD, CO-400, CO-400-B, CO-400-B-DD, CO-400-COLD, CO-400-COLD-B, CO-400-COLD-B-DD, CO-400-COLD-DD, CO-400-DD, CO-400-SOFT, EASY-500, EASY-500B, EASY-500DD, LVC-21B, LVC-21C, LVR-20, LVR-20B		



1

código	361354	referencia	12024178 Z213008
descripción	temporizador CDC 7804DV motores 2 cámaras 4 tiempo de funcionamiento 6s / 3min aliment. 230V eje ømm eje Lmm tipo de motor M37RN/M37LN		
Para modelos:	FI-48, FI-48B, FI-48D, FI-48W		



1

código	361355	referencia	12024177 Z243004
descripción	temporizador CDC 7804DV motores 2 cámaras 4 tiempo de funcionamiento 6s / 3min aliment. 230V eje ømm eje Lmm tipo de motor M37RN/M37LN		
Para modelos:	EASY-500HP, FI-64, FI-64AR, FI-64B, FI-64C, FI-64D, FI-72, FI-72AR, FI-80, FI-80AR, LABP-800		



1

código	360440	referencia	12024203 Z213002
descripción	temporizador CDC 7805DV motores 2 cámaras 5 tiempo de funcionamiento 6s / 3min aliment. 230V 50Hz eje ømm eje Lmm		
Para modelos:	FI-48, FI-48AR, FI-48B, FI-48B-BT-UK, FI-48C, FI-48D, FI-48HY-CLINIC, FI-48W, FI-64, FI-64B, FI-64W, MF-48, MF-64		



1

código	360438	referencia	12024202 Z258412
descripción	temporizador CDC 7805DV motores 2 cámaras 5 tiempo de funcionamiento 6s / 3min aliment. 230V 60Hz eje ømm eje Lmm		
Para modelos:	FI-48W, FI-64B, FI-64W, FI-72, FI-72W, FI-80BBT-UK, FI-80W, MF-48, MF-64		



1

código	360439	referencia	12024204 Z243001
descripción	temporizador CDC 7805DV motores 2 cámaras 5 tiempo de funcionamiento 6s/180s aliment. 230V 50Hz eje ømm eje Lmm		
Para modelos:	EASY-500HPWBDD, FI-48, FI-48B, FI-48W, FI-64, FI-64B, FI-64B-BT-UK, FI-64HY-CLINIC, FI-64W, MF-48, MF-64		



1

código	361352	referencia	12024089 Z403002
descripción	temporizador CDC 7903F motores 1 cámaras 3 tiempo de funcionamiento 120s aliment. 230V eje ø 6x4,6mm eje L 13mm lavavajillas		
Para modelos:	LVC-12, LVC-15, LVC-15D, LVC-21, LVC-21D, LVC-21W, LVR-10, LVR-14, LVR-14D, LVR-20, LVR-20D		



1

código	361351	referencia	12017667 12024087 Z203030 Z268302
descripción	temporizador CDC 7903F motores 1 cámaras 3 tiempo de funcionamiento 4min aliment. 230V eje ø 6x4,6mm eje L 13mm		
Para modelos:	FI-30, FI-30AR, FI-30AR+DD, FI-30B, FI-30B-BT-UK, FI-30-UK, FI-60DD, FI-64, FI-64B, FI-64W, FI-72, FI-80, FI-80W		



1

código	361356	referencia	12017561 Z703004
descripción	temporizador M48L ATS motores 2 cámaras 5 tiempo de funcionamiento 6s / 2min aliment. 230V eje ømm eje Lmm		
Para modelos:	ECO-120, ECO-1200, ECO-120B		

temporizadores mecánicos



1

código	360732	referencia	12030066 12049916 DO1DI13315 DO1DL13350
descripción	temporizador MT59 2 polos tiempo de funcionamiento 60min accionamiento mecánico 2NO a 250 V 16A posición permanente no eje ø6x4,6mm eje L 21mm distancia de sujeción 28mm empalme lateral parte plana abajo		
Para modelos:	SF-10, SF-13, SF-15, SF-22, SF-31, SF-8, SR-10MP-PSM, SR-13MP-PSM, SR-32MP-PSM		

contactores

GENERAL ELECTRIC (AEG)

contactores de potencia



1

código	380245	referencia	12031082 RT30280550
descripción	contactor de potencia AC1 25A 230VAC (AC3/400V) 9A/4kW contactos principales 3NO contactos auxiliares 1NC empalme empalme atornillado tipo AEG LS4K 01A tipo GE CL00A 301 H 85mm		



1

código	380244	referencia	12018159 12027320 12029911 12031081 R663031 RT30280551 RT4001554 RT4001556
descripción	contactor de potencia AC1 25A 230VAC (AC3/400V) 9A/4kW contactos principales 3NO contactos auxiliares 1NO empalme empalme atornillado tipo AEG LS4K 10A tipo GE CL00A 310		
Para modelos:	ECO-1600, ECO-160D, ECO-160I, ECO-200D, ECO-200HD, ECO-200HI, ECO-200I, ECO-2300, ECO-280D, ECO-280I, ECO-3000, ECO-370D, ECO-370I, ECO-460D, ECO-460I, ECO-550D, ECO-550I, FE-18, FE-25, FE-710, FI-120, FI-120B, FI-1600, FI-160D, FI-160I, FI-200D, FI-200HD, FI-200HI, FI-200I, FI-2300, FI-280D, FI-280I, FI-3000, FI-370D, FI-370I, FI-460D, FI-460I, FI-550D, FI-550I, HME-10-11, HME-10-21, HME-20-11, HME-20-21, HME-2-10-11, HME-6-11, HMI-10-11, HMI-10-11UL, HMI-10-21, HMI-10-21UL, HMI-2-10-11...(Otros modelos se puede ver en la tienda web)		



1

código	380261	referencia	12028282 12029618 12030540 ICR13042 RT30280552 RT4001555
descripción	contactor de potencia AC1 32A 230VAC (AC3/400V) 17A/7,5kW contactos principales 3NO contactos auxiliares 1NO empalme empalme atornillado tipo AEG LS7K 10A tipo GE CL02A 310		

ISKRA (FANAL)

contactores de potencia



1

código	380212	referencia	12000219 P453023
descripción	contactor de potencia AC1 20A 230VAC (AC3/400V) 8,5A/5,5kW contactos principales 3NO contactos auxiliares 1NC empalme empalme atornillado tipo FANAL K07M 01 tipo ISKRA DSL7 01		
Para modelos:	FE-6, FE-8, FI-300B, FI-300R, FI-650R		



SIEMENS

contactores de potencia



1

código	380614	referencia	12024040 12111795 Z203050
descripción	contactor de potencia AC1 22A 230VAC (AC3/400V) 9A/4kW contactos principales 3NO contactos auxiliares 1NO empalme grapas elásticas tipo 3RT2016-2AP01		
Para modelos:	ACE-061, ACE-101, AD-120, AD-120B, AD-120BBTDD-UK, AD-120C, AD-120CW, AD-120HY, AD-125, AD-125HRS, AD-125-SOFT, AD-90, AD-90BA, AD-90BBT, AD-90BDD, AD-90DD, ADE-120, ADE-120B, AE-061, AE-061W, AE-101, AE-101W, APE-061, APE-061W, APE-101, APE-101W, CO-110, CO-110B, CO-110BDD, CO-110DD, CO-112, CO-112B, CO-112BDD, CO-112DD, CO-142W, CO-142WDD, CO-170, CO-170B, CO-170BDD, CO-170DD, CO-170HRS, CO-170HRSDD, CO-170HRS-SOFT, CO-170-SOFT, CO-172, CO-172B, CO-172BDD, CO-172DD, COE-061, COE-101...(Otros modelos se puede ver en la tienda web)		



1

código	380390	referencia	12024075 12039754 12040142 R143002 R673007 X183011
descripción	contactor de potencia AC1 40A 230VAC (AC3/400V) 12A/5,5kW contactos principales 3NO contactos auxiliares empalme empalme atornillado tipo 3RT10-24-1AL20 50/60Hz		
Para modelos:	COE-102, COE-201, ECO-160, ECO-1600, ECO-160D, ECO-160I, ECO-200, ECO-200D, ECO-200H, ECO-200HD, ECO-200HI, ECO-200I, ECO-2300, ECO-2700D, ECO-2700I, ECO-280D, ECO-280I, ECO-3000, ECO-370D, ECO-370I, ECO-4000D, ECO-4000I, ECO-460D, ECO-460I, ECO-550D, ECO-550I, ECO-6000D, ECO-6000I, FE9-05, FE9-05-1C, FE9-05-2C, FE9-05AD, FE9-05PLUS, FE9-05PLUS-S, FE9-05S, FE9-05S-1C, FE9-05S-2C, FE9-05S-AD, FE9-05USMC, FE9-10, FE9-10-2C, FE9-10-4C, FE9-10AD, FE9-10PLUS, FE-920, FI-160, FI-1600, FI-160AR, FI-160D, FI-160I...(Otros modelos se puede ver en la tienda web)		

contactos auxiliares



1

código	380539	referencia	12023704 Z103070
descripción	contacto auxiliar contactos 1NO AC15 3A para contactores 3RT102 3 RT103 empalme empalme atornillado tipo 3RH1921-1CA10 AC1 10A AC-12 10A		
Para modelos:	ECO-160, ECO-1600, ECO-160D, ECO-160I, ECO-200, ECO-200D, ECO-200H, ECO-200HD, ECO-200HI, ECO-200I, ECO-2300, ECO-2700D, ECO-2700I, ECO-280D, ECO-280I, ECO-3000, ECO-370D, ECO-370I, ECO-4000D, ECO-4000I, ECO-460D, ECO-460I, ECO-550D, ECO-550I, ECO-6000D, ECO-6000I, FI-160, FI-1600, FI-160AR, FI-160D, FI-160I, FI-200, FI-200AR, FI-200D, FI-200H, FI-200HD, FI-200HI, FI-200I, FI-200W, FI-2300, FI-2700D, FI-2700I, FI-280D, FI-280I, FI-3000, FI-370D, FI-370I, FI-4000D, FI-4000I, FI-460D...(Otros modelos se puede ver en la tienda web)		

contactores pequeños



1

código	380696	referencia	12024012 Z683087
descripción	contactor pequeño aliment. 230V (AC3/400V) 9A/4kW contactos principales 3NO contactos auxiliares 1NC empalme conector Faston 6,3mm AC1 16A		
Para modelos:	AD-15, AD-15D, AD-20C-UK, AD-21, AD-21B, AD-21BDD, AD-21C, AD-21D, AD-21DD, AD-48, AD-48BDD, AD-48C, AD-48D, AD-48DD, AD-64, AD-64B, AD-64BDD, AD-64C, AD-64D, AD-64DD, AD-72, CO-110, CO-110B, CO-110BDD, CO-110DD, CO-112, CO-112B, CO-112BDD, CO-112DD, CO-170, CO-170B, CO-170BDD, CO-170DD, CO-170HRS, CO-170HRSDD, CO-170HRS-SOFT, CO-170-SOFT, CO-172, CO-172B, CO-172BDD, CO-172DD, COP-173, COP-173B, COP-173BDD, COP-173DD, COP-173HRS, COP-173HRSDD, COP-173-SOFT, COP-174, COP-174B...(Otros modelos se puede ver en la tienda web)		

relés

relés de potencia

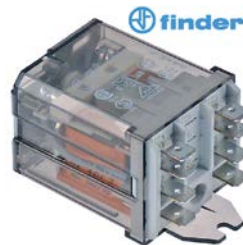

con lengüeta de sujeción



1

código	380139	referencia	12031875 EU929115
descripción	relé de potencia FINDER 230VAC 16A 2CO empalme F6,3 lengüeta de sujeción medidas 68x38,2x35,8mm N° fabricante 62.82.8.230.0000		

portarelés

			
1			
código	380136	referencia	12024185 R743009
descripción	zócalo de relé 11 polos empalme enchufable 11 polos medidas 65x28x40mm 250V tensión AC 10A Italiana Relè N° fabricante ZVE11		
Para modelos:	GA-20, GA-20D, GA-40, GA-40D, HGV-10-11, HGV-20-11, HMM-10-11, HMM-10-11UL, HMM-10-21, HMM-10-21UL, HMM-20-11, HMM-20-11UL, HMM-20-21, HMM-20-21UL, HMM-2-10-11, HMM-40-11-USMC, HMM-6-11, HMM-6-11UL, HVG-10-11, HVG-10-11UL, HVG-10-21, HVG-10-21UL, HVG-20-11, HVG-20-21, HVG-2-10-11, HVG-2-20-21, ME9-10PLUS-BM, ME9-10PLUS-BMS, ME9-15BM-AD, ME9-15PLUS-BM, ME9-15PLUS-BMS, MFHMM-20-11, MFHVG-10-11, MFHVG-10-21, MG9-10BMAD, MG9-10BMSAD, MG9-10PLUS-BM, MG9-10PLUS-BMS, MG9-15BMAD, MG9-15BMSAD, MG9-15PLUS-BM, MG9-15PLUS-BMS		
accesorios para	380136		
			
código	380805	referencia	—
estribo de retención			



relés de temporización

			
1			
código	360554	referencia	12024079 Z123022 Z123022000
descripción	relé de temporización TELEMECANIQUE RE17RMMU margen de tiempo 0,1s-100h 24-240VAC/24VDC 8A medida de montaje riel DINmm 1CO empalme empalme atornillado		
Para modelos:	ECO-160, ECO-1600, ECO-160D, ECO-160I, ECO-200, ECO-200D, ECO-200H, ECO-200HD, ECO-200HI, ECO-200I, ECO-2300, ECO-2700D, ECO-2700I, ECO-280D, ECO-280I, ECO-3000, ECO-370D, ECO-370I, ECO-4000D, ECO-4000I, ECO-460D, ECO-460I, ECO-550D, ECO-550I, ECO-6000D, ECO-6000I, FI-160, FI-1600, FI-160AR, FI-160D, FI-160I, FI-200, FI-200AR, FI-200D, FI-200H, FI-200HD, FI-200HI, FI-200I, FI-200W, FI-2300, FI-2700D, FI-2700I, FI-280D, FI-280I, FI-3000, FI-370D, FI-370I, FI-4000D, FI-4000I, FI-460D...(Otros modelos se puede ver en la tienda web)		

sensores



sensores universales

sondas de temperatura

			
1			
código	379630	referencia	6021350083
descripción	sensor de temperatura NTC 10kOhm cable termoplástico sonda -40 a +110°C cable -40 a +110°C bulbo ø6x14mm longitud de cable 2.5m sin racor de dos hilos resistencia 10kOhm		
			
1			
código	379142	referencia	12033839 6021350026
descripción	sensor de temperatura PTC 1kOhm cable PVC sonda -50 a +150°C cable -10 a 100°C bulbo ø6x30mm longitud de cable 1.5m sin racor de dos hilos		
Para modelos:	ATM-101, VTP-139-C, VTP-139-CD, VTP-139-P, VTP-139-PD, VTP-139-RC, VTP-139-RCD, VTP-139-RP, VTP-139-RPD, VTP-175-C, VTP-175-CD, VTP-175-P, VTP-175-PD, VTP-175-RC, VTP-175-RCD, VTP-175-RP, VTP-175-RPD		

sensores específicos del fabricante

sensores

			
1			
código	379550	referencia	12019258 Z233007
descripción	sensor de temperatura NTC 10kOhm cable silicona sonda -40 a +110°C cable -50 a +180°C empalme conector Faston rosca bulbo ø6x30mm longitud de cable 0.35m		
Para modelos:	FI-50		
			
1			
código	378339	referencia	12025036 Z713028
descripción	sensor de temperatura NTC 64kOhm cable silicona sonda -40 a +110°C cable -50 a +180°C empalme conector rosca bulbo ø6x14mm longitud de cable 2.5m		
Para modelos:	AD-120, AD-120B, AD-120BBTDD-UK, AD-120C, AD-120CW, AD-120HY, AD-125, AD-125HRS, AD-125-SOFT, AD-15, AD-15D, AD-20C-UK, AD-21, AD-21B, AD-21BDD, AD-21C, AD-21D, AD-21DD, AD-21W, AD-45BBT, AD-48, AD-48B, AD-48BDD, AD-48C, AD-48D, AD-48DD, AD-48HY, AD-48W, AD-505, AD-505-SOFT, AD-64, AD-64B, AD-64BBT, AD-64BDD, AD-64BTDD, AD-64C, AD-64CW, AD-64D, AD-64DD, AD-64HY, AD-72, AD-72W, AD-90, AD-90BA, AD-90BBT, AD-90BDD, AD-90DD, ADE-120, ADE-120B, CO-112...(Otros modelos se puede ver en la tienda web)		



electrónicas

placas electrónicas

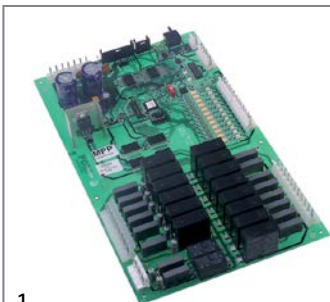

1

código	401788	referencia	12024457 P613005
descripción	placa base lavadora LA 10-13-18-25		
Para modelos:	LA-18MP, LA-AC-10MP, LA-AC-13MP, LA-AC-18MP, LA-AC-25MP, LA-E-10MP, LA-E-13MP, LA-E-18MP, LA-E-25MP, LA-V-10MP, LA-V-13MP, LA-V-18MP, LA-V-25MP, LF-13MPP, LF-18MPP, LF-25MPP, LF-8MPP, LR-AC-10MP, LR-AC-13MP, LR-AC-18MP, LR-AC-25MP, LR-E-10MP, LR-E-13MP, LR-E-18MP, LR-E-25MP, LR-V-10MP, LR-V-13MP, LR-V-18MP, LR-V-25MP		



1

código	403237	referencia	12024028 Z713017
descripción	placa de display lavavajillas AD15/21/48 L 100mm An 35mm		
Para modelos:	AD-120, AD-120B, AD-120BBTDD-UK, AD-120C, AD-120HY, AD-15, AD-15D, AD-20C-UK, AD-21, AD-21B, AD-21BDD, AD-21C, AD-21D, AD-21DD, AD-45BBT, AD-48, AD-48B, AD-48BDD, AD-48C, AD-48D, AD-48DD, AD-48HY, AD-64, AD-64B, AD-64BBT, AD-64BDD, AD-64BTDD, AD-64C, AD-64D, AD-64DD, AD-64HY, AD-72, AD-90, AD-90BA, AD-90BBT, AD-90BDD, AD-90DD, ADE-120, ADE-120B, CO-112, CO-112B, CO-112BDD, CO-112DD, CO-172, CO-172B, CO-172BDD, CO-172DD, CO-352-COLD, CO-352-COLD-B, CO-352-COLD-B-DD... (Otros modelos se puede ver en la tienda web)		



1

código	400810	referencia	12016516 Z233005
descripción	placa de regulación lavavajillas FI-50 con indicación		
Para modelos:	FI-50		



1

código	403308	referencia	12008750 Z213073
descripción	placa electrónica lavavajillas AD-72/48/64 L 128mm An 118mm apto para FAGOR con carcasa H 55mm para lavavajillas UE 1 pzs		
Para modelos:	AD-120, AD-120B, AD-120BBTDD-UK, AD-120C, AD-120CW, AD-120HY, AD-15, AD-15D, AD-20C-UK, AD-21, AD-21B, AD-21BDD, AD-21C, AD-21D, AD-21DD, AD-21W, AD-45BBT, AD-48, AD-48B, AD-48BDD, AD-48C, AD-48D, AD-48DD, AD-48HY, AD-48W, AD-64, AD-64B, AD-64BBT, AD-64BDD, AD-64BTDD, AD-64C, AD-64CW, AD-64D, AD-64DD, AD-64HY, AD-72, AD-72W, AD-90, AD-90BA, AD-90BBT, AD-90BDD, AD-90DD, ADE-120, ADE-120B, CO-112, CO-112B, CO-112BDD, CO-112DD, CO-142W, CO-142WDD... (Otros modelos se puede ver en la tienda web)		

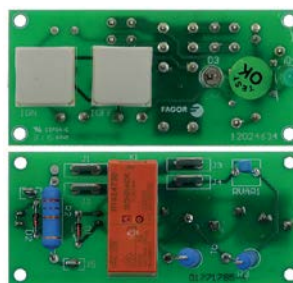

1

código	403743	referencia	12024634 Z218030 Z218030000
descripción	platina de control para lavavajillas L 75mm An 35mm para FAGOR		
Para modelos:	LA-AC-10M, LA-AC-10MP, LA-AC-13M, LA-AC-13MP, LA-AC-18M, LA-AC-18MP, LA-AC-25M, LA-AC-25MP, LA-E-10M, LA-E-10MP, LA-E-13M, LA-E-13MP, LA-E-18M, LA-E-18MP, LA-E-25M, LA-E-25MP, LA-V-10M, LA-V-10MP, LA-V-13M, LA-V-13MP, LA-V-18M, LA-V-18MP, LA-V-25M, LA-V-25MP, LB-AC-10M, LB-E-10M, LB-V-10M, LR-AC-10M, LR-AC-10MP, LR-AC-13M, LR-AC-13MP, LR-AC-18M, LR-AC-18MP, LR-AC-25M, LR-AC-25MP, LR-E-10M, LR-E-10MP, LR-E-13M, LR-E-13MP, LR-E-18M, LR-E-18MP, LR-E-25M, LR-E-25MP, LR-V-10M, LR-V-10MP, LR-V-13M, LR-V-13MP, LR-V-18M, LR-V-18MP, LR-V-25M... (Otros modelos se puede ver en la tienda web)		

unidades centrales

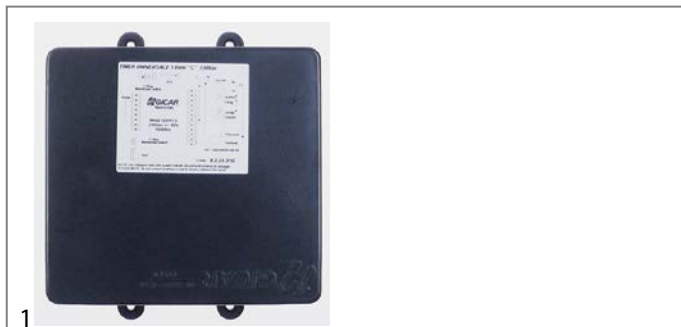

código	402991	referencia	12024809 Z213069
descripción	caja electrónica para lavavajillas 230V		
Para modelos:	AD-120, AD-120B, AD-120C, AD-120HY, AD-15, AD-15D, AD-20C-UK, AD-21, AD-21B, AD-21BDD, AD-21C, AD-21D, AD-21DD, AD-45BBT, AD-48, AD-48B, AD-48BDD, AD-48C, AD-48D, AD-48DD, AD-48HY, AD-64, AD-64B, AD-64BBT, AD-64BDD, AD-64C, AD-64D, AD-64DD, AD-64HY, AD-72, AD-90, AD-90DD, ADE-120, ADE-120B		

teclados

membranas de teclado

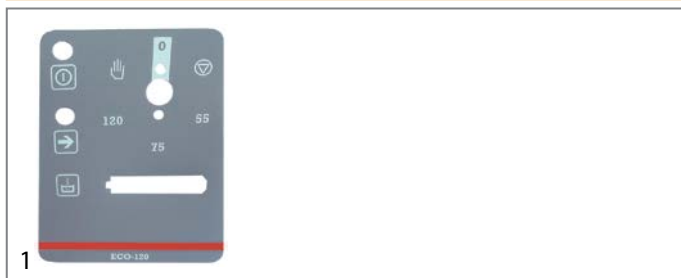

código	505205	referencia	12020129 Z732901
descripción	membrana de teclado lavavajillas ECO120		
Para modelos:	ECO-120, ECO-120B		



código	401843	referencia	12017916 Z322902
descripción	membrana de teclado lavavajillas ECO200 L 645mm An 173mm		
Para modelos:	ECO-200, ECO-200D, ECO-200H, ECO-200HD, ECO-200HI, ECO-200I		



código	505126	referencia	12019909 Z742906
descripción	membrana de teclado lavavajillas F180		
Para modelos:	FI-80		

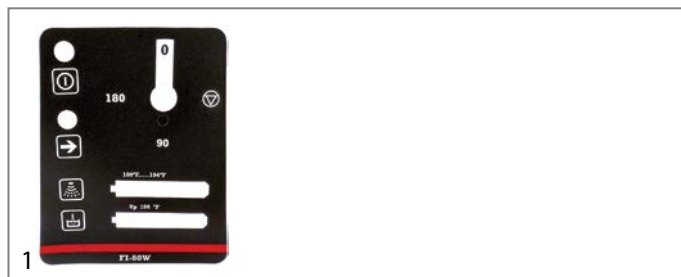

código	505127	referencia	12019473 Z748404
descripción	membrana de teclado lavavajillas F180		
Para modelos:	FI-80W		



código	505125	referencia	12020028 Z710516
descripción	membrana de teclado lavavajillas FI-100		
Para modelos:	ECO-120, ECO-120B, ECO-160D, ECO-160I, ECO-200D, ECO-200I, ECO-280D, ECO-280I, ECO-370D, ECO-370I, ECO-460D, ECO-460I, ECO-550D, ECO-550I, FI-100, FI-100AR, FI-100B, FI-120, FI-120B, FI-120W, FI-160D, FI-160I, FI-200D, FI-200I, FI-280D, FI-280I, FI-370D, FI-370I, FI-460D, FI-460I, FI-550D, FI-550I, FI-80, FI-80W		

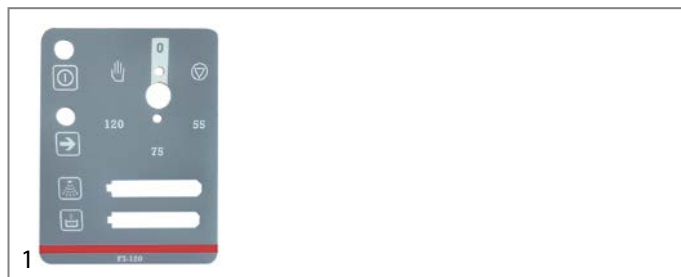

código	505204	referencia	12019475 Z722901
descripción	membrana de teclado lavavajillas FI120		
Para modelos:	FI-120, FI-120B		



código	505117	referencia	12020315 Z202909
descripción	membrana de teclado lavavajillas FI30		
Para modelos:	FI-30		





código	403240	referencia	12025130
descripción	membrana de teclado lavavajillas FI30 gris modelo FI30 para FAGOR L 585mm An 62.5mm		
Para modelos:	FI-30, FI-30AR, FI-30AR+DD, FI-30-UK		



			
código	403238	referencia	12023961 Z222903
descripción	membrana de teclado lavavajillas FI48 gris modelo FI-48B para FAGOR L 585mm An 62.5mm		
Para modelos:	FI-48, FI-48B		

			
código	505119	referencia	12020146 Z212910
descripción	membrana de teclado lavavajillas FI-48 tiempo de funcionamiento 120/180s		
Para modelos:	FI-48, FI-48W		

			
código	505120	referencia	12020147 Z222902
descripción	membrana de teclado lavavajillas FI-48B modelo FI-48B bomba de desagüe		
Para modelos:	FI-48B		

			
código	505118	referencia	12019162 Z232901
descripción	membrana de teclado lavavajillas FI-50 modelo FI-50		
Para modelos:	FI-50		

			
código	505121	referencia	12018990 Z242901
descripción	membrana de teclado lavavajillas FI-64 tiempo de funcionamiento 90/180s		
Para modelos:	FI-64, FI-64W		

			
código	505124	referencia	12018622 Z262906
descripción	membrana de teclado lavavajillas FI-72		
Para modelos:	FI-72		

			
código	505108	referencia	12020486 Z462901
descripción	membrana de teclado lavavajillas LVC12		
Para modelos:	LVC-12, LVC-15, LVC-21, LVR-10, LVR-14, LVR-20		

			
código	505109	referencia	12018909 Z412901
descripción	membrana de teclado lavavajillas LVC15		
Para modelos:	LVC-12, LVC-15, LVC-21, LVR-10, LVR-14, LVR-20		

			
código	505115	referencia	12019307 Z482901
descripción	membrana de teclado lavavajillas LVC15D		
Para modelos:	LVC-15D		

			
código	505113	referencia	12018973 Z472902
descripción	membrana de teclado lavavajillas LVC15D/21D/14D/20D		
Para modelos:	LVR-14D		

			
código	505114	referencia	Z492902
descripción	membrana de teclado lavavajillas LVC15D/21D/14D/20D		
Para modelos:	LVR-20D		

			
código	505110	referencia	12020451 Z442901
descripción	membrana de teclado lavavajillas LVC21		
Para modelos:	LVC-12, LVC-15, LVC-21, LVC-21W, LVR-10, LVR-14, LVR-20		

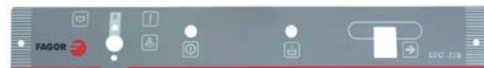
			
código	505112	referencia	12019096 Z452901
descripción	membrana de teclado lavavajillas LVC21B		
Para modelos:	LVC-21B, LVR-20B		

			
código	505116	referencia	12018125 Z502901
descripción	membrana de teclado lavavajillas LVC21D		
Para modelos:	LVC-21D		

			
1			
código	505105	referencia	12019135 Z392901
descripción	membrana de teclado lavavajillas LVR10		
Para modelos:	LVC-12, LVC-15, LVC-21, LVR-10, LVR-14, LVR-20		

			
1			
código	505106	referencia	Z402909
descripción	membrana de teclado lavavajillas LVR14		
Para modelos:	LVC-12, LVC-15, LVC-21, LVR-10, LVR-14, LVR-20		

			
1			
código	505202	referencia	12020127 Z712908
descripción	membrana de teclado sistemas de lavado FI100		
Para modelos:	FI-100, FI-100AR, FI-100B		

			
1			
código	505203	referencia	12020324 Z728501
descripción	membrana de teclado sistemas de lavado FI120		
Para modelos:	FI-120W, MF-120		

			
1			
código	505123	referencia	12018989 Z252901
descripción	membrana de teclado sistemas de lavado FI-64B/FI64W		
Para modelos:	FI-64B		

			
1			
código	505122	referencia	12019191 Z258501
descripción	membrana de teclado sistemas de lavado FI-64B/FI64W modelo FI-64B/FI64W bomba de desagüe		
Para modelos:	FI-64B, MF-64		

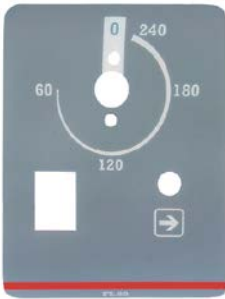
			
1			
código	505201	referencia	Z742901
descripción	membrana de teclado sistemas de lavado FI80		
Para modelos:	FI-80		

teclados de membrana

			
1			
código	403466	referencia	12024723
descripción	teclado de membrana lavavajillas AD48/AD64 tazas 4 apto para FAGOR UE 1 pzs L 585mm An 50mm		
Para modelos:	AD-45BBT, AD-48B, AD-48BDD, AD-48C, AD-64B, AD-64BBT, AD-64BDD, AD-64C		

			
1			
código	403467	referencia	12023437
descripción	teclado de membrana lavavajillas AD90 tazas 4 apto para FAGOR UE 1 pzs L 200mm An 120mm		
Para modelos:	AD-90, AD-90DD		

			
1			
código	402579	referencia	12023215
descripción	teclado de membrana sistemas de lavado LA13 tazas 6 L 640mm An 160mm		
Para modelos:	LA-13M, LB-AC-10M, LB-E-10M, LB-V-10M		



válvulas magnéticas

válvulas magnéticas agua

ELBI

recto



código	373025	referencia	12023921 Z611123
descripción	válvula magnética triple recto 230VAC entrada 3/4" salida 11,5mm DN10 ELBI		
Para modelos:	AE-061, AE-061W, AE-101, AE-101W, AE-102, AE-102W, AE-201, AE-202, AG-061, AG-061W, AG-101, AG-101W, AG-102, AG-102W, AG-201, AG-202, APE-061, APE-061W, APE-101, APE-101W, APE-102, APE-102W, APE-201, APE-202, APG-061, APG-061W, APG-101, APG-101W, APG-102, APG-102W, APG-201, APG-202, HEM-10-11, HEM-20-11, HEM-6-11, HEP-10-11, HEP-20-11, HEP-6-11, LA-13M, LA-18MP, LA-25M, LA-AC-10M, LA-AC-10MA, LA-AC-10MP, LA-AC-13M, LA-AC-13MA, LA-AC-13MP, LA-AC-18M, LA-AC-18MA, LA-AC-18MP...(Otros modelos se puede ver en la tienda web)		
repuestos para	373025		
		código	370467 referencia —
	filtro de válvula magnética apto para ELBI		

ROBERTSHAW/INVENSYS

temperatura líquido: 90°C 90°C 60°C
 temperatura ambiente: 60°C 25°C 60°C
 ciclo de trabajo: 40% 100% 100%



código	372025	referencia	12003285 Z611124
descripción	válvula magnética triple recto 230VAC entrada 3/4" salida 11,5mm DN10 EATON (INVENSYS)		
Para modelos:	AD-15D, AD-21D, LVC-15D, LVC-21D, LVR-14D, LVR-20D		

TP			
código	370021	referencia	12023794 12032085 EU929172 P255001
descripción	válvula magnética doble recto 230VAC entrada 3/4" salida 11,5mm DN10 TP reducción entrada A blanco		
Para modelos:	ACE-061, ACE-101, ACE-102, ACE-201, ACE-202, ACG-061, ACG-101, ACG-102, ACG-201, ACG-202, AD-15, AD-20C-UK, AD-21, AD-21B, AD-21BDD, AD-21C, AD-21DD, AD-21W, AD-48D, AD-64D, AE-061, AE-101, AE-102, AE-201, AE-202, AG-061, AG-101, AG-102, AG-201, AG-202, COE-061, COE-101, COE-102, COE-201, COE-202, CPE9-05, CPE9-05AD, CPE9-05AD-S, CPE9-05NC, CPE9-05PLUS, CPE9-05PLUS-S, CPE9-05S, CPE9-05SNC, CPG9-05, CPG9-05AD, CPG9-05AD-S, CPG9-05NC, CPG9-05PLUS, CPG9-05PLUS-S, CPG9-05S...(Otros modelos se puede ver en la tienda web)		
accesorios para	370021		
		código	371220 referencia —
	reducción TP velocidad de flujo 3l/min rojo tolerancia ±15%		
		código	371221 referencia —
	reducción TP velocidad de flujo 5.5l/min amarillo tolerancia ±15%		
		código	371222 referencia —
	reducción TP velocidad de flujo 6l/min gris tolerancia ±15%		
		código	371223 referencia —
	reducción TP velocidad de flujo 10l/min blanco tolerancia ±15%		
		código	371224 referencia —
	reducción TP velocidad de flujo 12l/min bronce tolerancia ±15%		
		código	371225 referencia —
	reducción TP velocidad de flujo 16l/min marrón claro tolerancia ±15%		
		código	371226 referencia —
	reducción TP velocidad de flujo 20l/min rojo tolerancia ±15%		
		código	371230 referencia —
	reducción TP velocidad de flujo 0.25l/min rojo tolerancia ±25%		
		código	371231 referencia —
	reducción TP velocidad de flujo 0.35l/min violeta tolerancia ±25%		
		código	371232 referencia —
	reducción TP velocidad de flujo 0.5l/min naranja tolerancia ±25%		
		código	371233 referencia —
	reducción TP velocidad de flujo 0.8l/min blanco tolerancia ±25%		
		código	371234 referencia 12025263 P305013
	reducción TP velocidad de flujo 1l/min azul claro tolerancia ±25%		
		código	371235 referencia —
	reducción TP velocidad de flujo 1.2l/min marrón tolerancia ±25%		

Continúa en la página siguiente















accesorios para	370021		
	código	371236	referencia —
	reducción TP velocidad de flujo 1.5l/min marrón claro tolerancia ±25%		
	código	371237	referencia —
	reducción TP velocidad de flujo 2.5l/min amarillo tolerancia ±25%		
	código	371238	referencia —
	reducción TP velocidad de flujo 3.4l/min verde oscuro tolerancia ±25%		
	código	371239	referencia —
	reducción TP velocidad de flujo 5l/min negro tolerancia ±25%		
	código	371240	referencia —
	reducción TP velocidad de flujo 8l/min azul tolerancia ±20%		

<p>componenti per elettrodomestici</p> <p>1</p>			
código	370017	referencia	12025161 Z701135
descripción	válvula magnética simple recto 230VAC entrada 3/4" salida 11,5mm DN10 TP p máx. 10bar		
Para modelos:	ACE-061, ACE-101, ACE-102, ACE-201, ACE-202, ACG-061, ACG-101, ACG-102, ACG-201, ACG-202, AD-120, AD-120B, AD-120BBTDD-UK, AD-120C, AD-120HY, AD-45BBT, AD-48, AD-48B, AD-48BDD, AD-48C, AD-48DD, AD-48HY, AD-48W, AD-64, AD-64B, AD-64BBT, AD-64BDD, AD-64BTDD, AD-64C, AD-64CW, AD-64D, AD-64DD, AD-64HY, AD-72, AD-72W, AD-90, AD-90BA, AD-90BBT, AD-90BDD, AD-90DD, AE-061, AE-061W, AE-101, AE-101W, AE-102, AE-102W, AE-201, AE-202, AG-061, AG-061W...(Otros modelos se puede ver en la tienda web)		
repuestos para	370017		
	código	371013	referencia —
	bobina magnética TP 230VAC 50/60Hz		
accesorios para	370017		
	código	371220	referencia —
	reducción TP velocidad de flujo 3l/min rojo tolerancia ±15%		
	código	371221	referencia —
	reducción TP velocidad de flujo 5.5l/min amarillo tolerancia ±15%		
	código	371222	referencia —
	reducción TP velocidad de flujo 6l/min gris tolerancia ±15%		
	código	371223	referencia —
	reducción TP velocidad de flujo 10l/min blanco tolerancia ±15%		
	código	371224	referencia —
	reducción TP velocidad de flujo 12l/min bronce tolerancia ±15%		
	código	371225	referencia —
	reducción TP velocidad de flujo 16l/min marrón claro tolerancia ±15%		
	código	371226	referencia —
	reducción TP velocidad de flujo 20l/min rojo tolerancia ±15%		

accesorios para	370017		
	código	371230	referencia —
	reducción TP velocidad de flujo 0.25l/min rojo tolerancia ±25%		
	código	371231	referencia —
	reducción TP velocidad de flujo 0.35l/min violeta tolerancia ±25%		
	código	371232	referencia —
	reducción TP velocidad de flujo 0.5l/min naranja tolerancia ±25%		
	código	371233	referencia —
	reducción TP velocidad de flujo 0.8l/min blanco tolerancia ±25%		
	código	371234	referencia 12025263 P305013
	reducción TP velocidad de flujo 1l/min azul claro tolerancia ±25%		
	código	371235	referencia —
	reducción TP velocidad de flujo 1.2l/min marrón tolerancia ±25%		
	código	371236	referencia —
	reducción TP velocidad de flujo 1.5l/min marrón claro tolerancia ±25%		
	código	371237	referencia —
	reducción TP velocidad de flujo 2.5l/min amarillo tolerancia ±25%		
	código	371238	referencia —
	reducción TP velocidad de flujo 3.4l/min verde oscuro tolerancia ±25%		
	código	371239	referencia —
	reducción TP velocidad de flujo 5l/min negro tolerancia ±25%		
	código	371240	referencia —
	reducción TP velocidad de flujo 8l/min azul tolerancia ±20%		

<p>componenti per elettrodomestici</p> <p>1</p>			
código	370018	referencia	12034078
descripción	válvula magnética simple recto 230VAC entrada 3/4" salida 14mm DN10 TP		
repuestos para	370018		
	código	371013	referencia —
	bobina magnética TP 230VAC 50/60Hz		
accesorios para	370018		
	código	371220	referencia —
	reducción TP velocidad de flujo 3l/min rojo tolerancia ±15%		
	código	371221	referencia —
	reducción TP velocidad de flujo 5.5l/min amarillo tolerancia ±15%		
	código	371222	referencia —
	reducción TP velocidad de flujo 6l/min gris tolerancia ±15%		

Continúa en la página siguiente

accesorios para		370018	
	código	371223	referencia —
	reducción TP velocidad de flujo 10l/min blanco tolerancia ±15%		
	código	371224	referencia —
	reducción TP velocidad de flujo 12l/min bronce tolerancia ±15%		
	código	371225	referencia —
	reducción TP velocidad de flujo 16l/min marrón claro tolerancia ±15%		
	código	371226	referencia —
	reducción TP velocidad de flujo 20l/min rojo tolerancia ±15%		
	código	371230	referencia —
	reducción TP velocidad de flujo 0.25l/min rojo tolerancia ±25%		
	código	371231	referencia —
	reducción TP velocidad de flujo 0.35l/min violeta tolerancia ±25%		
	código	371232	referencia —
	reducción TP velocidad de flujo 0.5l/min naranja tolerancia ±25%		
	código	371233	referencia —
	reducción TP velocidad de flujo 0.8l/min blanco tolerancia ±25%		
	código	371234	referencia 12025263 P305013
	reducción TP velocidad de flujo 1l/min azul claro tolerancia ±25%		
	código	371235	referencia —
	reducción TP velocidad de flujo 1.2l/min marrón tolerancia ±25%		
	código	371236	referencia —
	reducción TP velocidad de flujo 1.5l/min marrón claro tolerancia ±25%		
	código	371237	referencia —
	reducción TP velocidad de flujo 2.5l/min amarillo tolerancia ±25%		
	código	371238	referencia —
	reducción TP velocidad de flujo 3.4l/min verde oscuro tolerancia ±25%		
	código	371239	referencia —
	reducción TP velocidad de flujo 5l/min negro tolerancia ±25%		
	código	371240	referencia —
	reducción TP velocidad de flujo 8l/min azul tolerancia ±20%		

válvulas magnéticas con reducciones



1

código	370427	referencia	12033258 BR00023001
descripción	válvula magnética simple acodado 230VAC entrada 3/4" salida 11,5mm reducción entrada Al/min reducción salida 1.2l/min DN10 T máx 90°C TP plástico reducción salida marrón oscuro		



1

código	370245	referencia	EPGC3120530
descripción	válvula magnética simple recto 24VAC entrada 3/4" salida 11,5mm reducción entrada A 16l/min T máx 90°C TP plástico reducción entrada A marrón claro		



1

código	370250	referencia	P443018000
descripción	válvula magnética triple recto 230VAC entrada 3/4" salida 11,5mm T máx 90°C TP plástico reducción salida B 0.25l/min reducción salida B rojo		

recambios y accesorios

reducciones

salida



1

código	371234	referencia	12025263 P305013
descripción	reducción TP velocidad de flujo 1l/min azul claro tolerancia ±25%		
Para modelos:	ACE-061, ACE-101, ACE-102, ACE-201, ACE-202, ACG-061, ACG-101, AD-48D, AD-64D, AE-061, AE-101, AE-102, AE-201, AE-202, AG-061, AG-101, AG-102, AG-201, AG-202, APE-061, APE-101, APE-102, APE-201, APE-202, APG-061, APG-101, APG-102, APG-201, APG-202, COE-202, FI-48, FI-48AR, FI-48B, FI-48B-BT-UK, FI-48C, FI-48D, FI-48HY-CLINIC, FI-48W, FI-64, FI-64AR, FI-64B, FI-64B-BT-UK, FI-64C, FI-64D, FI-64HY-CLINIC, FI-64W, HCV-10-11, HCV-5-11, HE-10-11, HE-10-21... (Otros modelos se puede ver en la tienda web)		

			
1			
código	691082	referencia	12024045 Z601156
descripción	reducción velocidad de flujo 8l/min violeta tolerancia ±25%		
Para modelos:	AD-45BBT, AD-48HY, AD-64BBT, AD-64BTDD, AD-64HY, AE-061, AE-101, AE-102, AE-201, AE-202, AG-061, AG-101, AG-102, AG-201, AG-202, APE-061, APE-101, APE-102, APE-201, APE-202, APG-061, APG-101, APG-102, APG-201, APG-202, BME7-05, BME7-10, BMG7-10, CPE9-05, CPE9-05AD, CPE9-05AD-S, CPE9-05NC, CPE9-05PLUS, CPE9-05PLUS-S, CPE9-05S, CPE9-05SNC, CPG9-05, CPG9-05AD, CPG9-05AD-S, CPG9-05NC, CPG9-05PLUS, CPG9-05PLUS-S, CPG9-05S, CPG9-05SNC, ECO-2700D, ECO-2700I, ECO-4000D, ECO-4000I, ECO-550D, ECO-550I...(Otros modelos se puede ver en la tienda web)		

metal			
			
1			
código	370488	referencia	1200000139 12005276 12038329 Z718415
descripción	válvula magnética 2vías 240VAC L 90mm DANFOSS 60Hz		
Para modelos:	AD-120CW, FI-100, FI-120, FI-120W, FI-200WL, FI-200WR, FI-80W		

			
1			
código	370725	referencia	12023551 Z102305
descripción	válvula magnética latón 2vías entrada 3/4" H salida 3/4" H L 90mm sin solenoide T máx 90°C DANFOSS serie EV220B 18 p máx. 10bar p mín. 0.3bar		
Para modelos:	ECO-1600, ECO-2300, ECO-280D, ECO-280I, ECO-3000, ECO-370D, ECO-370I, ECO-460D, ECO-460I, ECO-550D, ECO-550I, FI-120W, FI-1600, FI-2300, FI-2700D, FI-2700I, FI-280D, FI-280I, FI-3000, FI-370D, FI-370I, FI-4000D, FI-4000I, FI-460D, FI-460I, FI-550D, FI-550I, FI-6000D, FI-6000I, LA-25M, LA-AC-25M, LA-AC-25MA, LA-AC-25MP, LAC-25, LAC-25MP, LAC-25MPP, LAC-55, LAC-55MP, LAC-55MPP, LA-E-25M, LA-E-25MA, LA-E-25MP, LA-V-25M, LA-V-25MP, LC-25, LC-AC-25, LC-E-25, LC-V-25, LF-25MPP, LF-AC-25...(Otros modelos se puede ver en la tienda web)		

válvulas de desagüe			
			
1			
código	370789	referencia	12024781 P302120
descripción	válvula de desagüe 220-240V 50/60Hz NO entrada 50mm salida 50/35mm MDB-O-2-SO		
Para modelos:	LA-13M, LA-18MP, LA-AC-10M, LA-AC-10MA, LA-AC-10MP, LA-AC-13M, LA-AC-13MA, LA-AC-13MP, LA-AC-18M, LA-AC-18MA, LA-AC-18MP, LAC-10, LAC-10MP, LAC-10MPP, LAC-14, LAC-14MP, LAC-14MPP, LAC-7, LAC-7MP, LAC-7MPP, LA-E-10M, LA-E-10MA, LA-E-10MP, LA-E-13M, LA-E-13MA, LA-E-13MP, LA-E-18M, LA-E-18MA, LA-E-18MP, LA-V-10M, LA-V-10MP, LA-V-13M, LA-V-13MP, LA-V-18M, LA-V-18MP, LB-AC-10M, LB-E-10M, LB-V-10M, LC-10, LC-14, LC-7, LC-AC-10, LC-AC-10A, LC-AC-14, LC-AC-14A, LC-AC-7, LC-AC-7A, LC-E-10, LC-E-10A, LC-E-14...(Otros modelos se puede ver en la tienda web)		

presostatos			
para sistemas de lavado			
ø58mm con conector Faston 6,3mm			
con empalme horizontal			
			
1			
código	541137	referencia	12025063 Z513001
descripción	presostato margen de presión 155/40mbar empalme 6mm ø 58mm conexión de presión horizontal sistemas de lavado		
Para modelos:	ECO-2700D, ECO-2700I, ECO-4000D, ECO-4000I, ECO-6000D, ECO-6000I, FI-120HY-CLINIC, FI-2700D, FI-2700I, FI-4000D, FI-4000I, FI-6000D, FI-6000I		

			
1			
código	541776	referencia	12023804 Z713002
descripción	presostato margen de presión 170/95mbar empalme 6mm ø 58mm conexión de presión horizontal sistemas de lavado		
Para modelos:	AD-120, AD-120B, AD-120BBTDD-UK, AD-120C, AD-120CW, AD-120HY, AD-45BBT, AD-48HY, AD-64BBT, AD-64HY, AD-90, AD-90BA, AD-90BBT, AD-90BDD, AD-90DD, ADE-120, ADE-120B, ECO-120, ECO-120B, FI-100, FI-100AR, FI-100B, FI-100BBT-UK, FI-120, FI-120AR+DD, FI-120B, FI-120C, FI-120HY-CLINIC, FI-120W, FI-80, FI-80AR, FI-80BBT-UK, FI-80W, FI-E-100, LABP-1000, LABP-1200, LABP-800, MF-120		



1

código	541885	referencia	12023855 Z273006
descripción	presostato margen de presión 205/40mbar empalme 6mm ø 58mm conexión de presión horizontal empalme presión ø 5.5mm		
Para modelos:	ECO-160, ECO-160D, ECO-160I, ECO-200, ECO-200D, ECO-200H, ECO-200HD, ECO-200HI, ECO-200I, ECO-280D, ECO-280I, ECO-370D, ECO-370I, ECO-460D, ECO-460I, ECO-550D, ECO-550I, FI-160, FI-160AR, FI-160D, FI-160I, FI-200, FI-200AR, FI-200D, FI-200H, FI-200HD, FI-200HI, FI-200I, FI-200W, FI-200WL, FI-200WR, FI-280D, FI-280I, FI-370D, FI-370I, FI-460D, FI-460I, FI-550D, FI-550I		



1

código	541832	referencia	12023856 Z713098
descripción	presostato margen de presión 24,7/22,2mbar empalme 6mm ø 58mm conexión de presión horizontal sistemas de lavado empalme presión ø 6mm		
Para modelos:	AD-120B, AD-120BBTDD-UK, AD-120C, AD-120HY, AD-90BA, AD-90BBT, AD-90BDD, ADE-120B, ECO-120B, FI-100, FI-100AR, FI-100B, FI-100BBT-UK, FI-120B, FI-120C, FI-120HY-CLINIC, FI-80BBT-UK		



1

código	541864	referencia	12023803 Z403021
descripción	presostato margen de presión 28/13mbar empalme 6mm ø 58mm conexión de presión horizontal sistemas de lavado apto para FAGOR		
Para modelos:	AD-15, AD-15D, AD-21, AD-21B, AD-21C, AD-21D, AD-21DD, CO-350, CO-350-B, CO-350-B-DD, CO-350-COLD, CO-350-COLD-B, CO-350-COLD-B-DD, CO-350-COLD-DD, CO-350-DD, CO-352-COLD, CO-352-COLD-B, CO-352-COLD-B-DD, CO-352-COLD-DD, CO-400, CO-400-B, CO-400-B-DD, CO-400-COLD, CO-400-COLD-B, CO-400-COLD-B-DD, CO-400-COLD-DD, CO-400-DD, CO-400-SOFT, CO-402-COLD, CO-402-COLD-B, CO-402-COLD-B-DD, CO-402-COLD-DD, ECO-280D, ECO-280I, ECO-370D, ECO-370I, ECO-460D, ECO-460I, ECO-550D, ECO-550I, FI-160AR, FI-160D, FI-160I, FI-200AR, FI-200D, FI-200HD, FI-200HI, FI-200I, FI-200WL, FI-200WR...(Otros modelos se puede ver en la tienda web)		



1

código	541302	referencia	12023802 Z203023
descripción	presostato margen de presión 40/15mbar empalme 6mm ø 58mm conexión de presión horizontal sistemas de lavado		
Para modelos:	AD-45BBT, AD-48, AD-48B, AD-48BDD, AD-48C, AD-48D, AD-48DD, AD-48HY, AD-48W, AD-64, AD-64B, AD-64BBT, AD-64BDD, AD-64BTDD, AD-64C, AD-64CW, AD-64D, AD-64DD, AD-64HY, AD-72, AD-72W, EASY-500, EASY-500B, EASY-500DD, EASY-500HP, EASY-500HPWBDD, FI-120HY-CLINIC, FI-30, FI-30AR, FI-30AR+DD, FI-30B, FI-30B-BT-UK, FI-30-UK, FI-48, FI-48AR, FI-48B, FI-48B-BT-UK, FI-48C, FI-48D, FI-48HY-CLINIC, FI-48W, FI-50, FI-60DD, FI-64, FI-64AR, FI-64B, FI-64B-BT-UK, FI-64C, FI-64D, FI-64HY-CLINIC...(Otros modelos se puede ver en la tienda web)		

1

código	541593	referencia	12023854 Z313006
descripción	presostato margen de presión 50/35mbar empalme 6mm ø 58mm conexión de presión horizontal		
Para modelos:	ECO-2700D, ECO-2700I, ECO-280D, ECO-280I, ECO-370D, ECO-370I, ECO-4000D, ECO-4000I, ECO-460D, ECO-460I, ECO-550D, ECO-550I, ECO-6000D, ECO-6000I, FI-2700D, FI-2700I, FI-280D, FI-280I, FI-370D, FI-370I, FI-4000D, FI-4000I, FI-460D, FI-460I, FI-550D, FI-550I, FI-6000D, FI-6000I		

1

código	541594	referencia	12020076 Z683071
descripción	presostato margen de presión 85/50mbar empalme 6mm ø 58mm conexión de presión horizontal empalme presión ø 6mm		
Para modelos:	ECO-1200, FI-1200, FI-900		

1

código	541299	referencia	12023805 Z223005
descripción	presostato margen de presión 95/75mbar empalme 6mm ø 58mm conexión de presión horizontal sistemas de lavado empalme presión ø 6mm		
Para modelos:	AD-48B, AD-48BDD, AD-48C, AD-48HY, AD-48W, AD-64B, AD-64BBT, AD-64BDD, AD-64C, AD-64CW, AD-64HY, AD-72W, EASY-500B, EASY-500HPWBDD, FI-30, FI-30AR, FI-30AR+DD, FI-30B, FI-30B-BT-UK, FI-30-UK, FI-48, FI-48AR, FI-48B, FI-48B-BT-UK, FI-48C, FI-48D, FI-48HY-CLINIC, FI-48W, FI-64, FI-64AR, FI-64B, FI-64B-BT-UK, FI-64C, FI-64D, FI-64HY-CLINIC, FI-64W, MF-48, MF-64		



ø84mm con conector codificado



código	541296	referencia	12024981 Z433011
descripción	presostato 2 márgenes de presión margen de presión 28/13 65/50mbar empalme 6mm ø 84mm conexión de presión horizontal sistemas de lavado empalme presión ø 5.5mm		
Para modelos:	AD-20C-UK, AD-21B, AD-21BDD, AD-21C, AD-21W, CO-350, CO-350-B, CO-350-B-DD, CO-350-COLD, CO-350-COLD-B, CO-350-COLD-B-DD, CO-350-COLD-DD, CO-350-DD, CO-352-COLD, CO-352-COLD-B, CO-352-COLD-B-DD, CO-352-COLD-DD, CO-400, CO-400-B, CO-400-B-DD, CO-400-COLD, CO-400-COLD-B, CO-400-COLD-B-DD, CO-400-COLD-DD, CO-400-DD, CO-400-DD-DD, CO-400-SOFT, CO-402-COLD, CO-402-COLD-B, CO-402-COLD-B-DD, CO-402-COLD-DD, CO-402W, LVC-21B, LVC-21C, LVC-21W, MF-21		



código	541592	referencia	12024269 Z213059
descripción	presostato 3 márgenes de presión margen de presión 40/15 120/60 150/95mbar empalme 6mm ø 84mm empalme presión ø 6mm		
Para modelos:	AD-120BBTDD-UK, AD-120HY, AD-45BBT, AD-48HY, AD-64BBT, AD-64BTDD, AD-64HY, AD-90BA, AD-90BBT, AD-90BDD, EASY-500HPWBDD, FI-100BBT-UK, FI-120HY-CLINIC, FI-30B-BT-UK, FI-48B-BT-UK, FI-48HY-CLINIC, FI-64B-BT-UK, FI-64HY-CLINIC, FI-80BBT-UK		

accesorios



código	541109	referencia	12023510 Z103077
descripción	pieza Y plástico tubo ø 8-6-8mm para presóstato		
Para modelos:	AD-120B, AD-120BBTDD-UK, AD-120C, AD-120HY, AD-45BBT, AD-48B, AD-48BDD, AD-48C, AD-48HY, AD-48W, AD-64B, AD-64BBT, AD-64BDD, AD-64BTDD, AD-64C, AD-64CW, AD-64HY, AD-72W, AD-90BA, AD-90BBT, AD-90BDD, ADE-120B, CO-500, CO-500B, CO-500BDD, CO-500DD, CO-501, CO-501B, CO-501BDD, CO-501DD, CO-501-SOFT, CO-502B, CO-502BDD, CO-502DD, CO-502W, COP-503, COP-503B, COP-503BDD, COP-503DD, COP-503-SOFT, COP-504, COP-504B, COP-504BDD, COP-504DD, COP-504W, EASY-500B, EASY-500HPWBDD, ECO-120B, ECO-160, ECO-1600...(Otros modelos se puede ver en la tienda web)		



código	541598	referencia	12023163 Z602923
descripción	soporte acero inoxidable H 37mm L 60mm An 12mm para presóstato		
Para modelos:	AD-120, AD-120B, AD-120BBTDD-UK, AD-120C, AD-120CW, AD-120HY, AD-45BBT, AD-48HY, AD-48W, AD-64BBT, AD-64BTDD, AD-64CW, AD-64HY, AD-72W, AD-90, AD-90BA, AD-90BBT, AD-90BDD, AD-90DD, ADE-120, ADE-120B, CO-350, CO-350-B, CO-350-B-DD, CO-350-COLD, CO-350-COLD-B, CO-350-COLD-B-DD, CO-350-COLD-DD, CO-350-DD, CO-352-COLD, CO-352-COLD-B, CO-352-COLD-B-DD, CO-352-COLD-DD, CO-400, CO-400-B, CO-400-B-DD, CO-400-COLD, CO-400-COLD-B, CO-400-COLD-B-DD, CO-400-COLD-DD, CO-400-DD, CO-400-SOFT, CO-402-COLD, CO-402-COLD-B, CO-402-COLD-B-DD, CO-402-COLD-DD, CO-402W, EASY-500, EASY-500B, EASY-500DD...(Otros modelos se puede ver en la tienda web)		

ventiladores

ventilador axial

importación



código	601080 ¹	referencia	12023862 12031028 12031777 12032776 6021050006 RT31011008 ST25000040 Z103066
descripción	ventilador axial L 119mm An 119mm H 38mm 230VAC 50/60Hz 23/20W cojinete rodamiento de bolas empalme conector Faston 2,8mm metal ADDA rodete ventilador ø 110mm resis.a la temp. 70°C		
Para modelos:	ACE-061, ACE-101, ACE-102, ACG-061, ACG-101, ACG-102, AD-120, AD-120B, AD-120BBTDD-UK, AD-120C, AD-120CW, AD-120HY, AD-90, AD-90BA, AD-90BBT, AD-90BDD, AD-90DD, AE-061, AE-101, AE-102, AG-061, AG-101, AG-102, APE-061, APE-101, APE-102, APG-061, APG-101, APG-102, CI9-20, CI9-40, COE-061, COE-101, COE-102, COE-201, COG-061, COG-101, COG-102, COG-201, ECO-120, ECO-120B, ECO-160, ECO-1600, ECO-160D, ECO-160I, ECO-200, ECO-200D, ECO-200H, ECO-200HD, ECO-200HI...(Otros modelos se puede ver en la tienda web)		
accesorios para	601080		
	código	550898	referencia —
	cable de conexión longitud del cable 2000mm empalme F 2,8 distancia de empalme 7.9mm para ventilador axial		
	código	692519	referencia 12025177 Z713015
	rejilla de protección L 120mm An 120mm plástico		

¹con rodamiento de bolas



accesorios

rejillas ventiladores



1

código	692519	referencia	12025177 Z713015
---------------	--------	-------------------	---------------------

descripción rejilla de protección L 120mm An 120mm plástico

Para modelos: AD-120, AD-120B, AD-120BBTDD-UK, AD-120C, AD-120CW, AD-120HY, AD-90, AD-90BA, AD-90BBT, AD-90BDD, AD-90DD, ADE-120, ADE-120B, ECO-120, ECO-120B, FI-100, FI-100AR, FI-100B, FI-100BBT-UK, FI-120, FI-120AR+DD, FI-120B, FI-120C, FI-120HY-CLINIC, FI-120W, FI-80, FI-80AR, FI-80BBT-UK, FI-80W, FI-E-100, LABP-1000, LABP-1200

accesorios para 692519



código	601080	referencia	12023862 12031028 12031777 12032776 6021050006 RT31011008 ST25000040 Z103066
---------------	--------	-------------------	---

ventilador axial L 119mm An 119mm H 38mm 230VAC 50/60Hz 23/20W cojinete rodamiento de bolas empalme conector Faston 2,8mm metal ADDA rodete ventilador ø 110mm resis.a la temp. 70°C



1

código	500783	referencia	12024739 Z275073 Z275074
descripción	motorreductor tipo 71E00147 250W 230/400V 50/60Hz fases 3 L 365mm An 200mm H 170mm MI 50 transmisión 100/1 para lavavajillas		
Para modelos:	ECO-160, ECO-160D, ECO-160I, FI-160, FI-160AR, FI-160D, FI-160I		

accesorios

amortiguadores de vibraciones



1

código	524000	referencia	12025159 Z710316
descripción	amortiguador de vibraciones H 15mm ø 20mm rosca M6 rosca L 14mm		
Para modelos:	AD-120, AD-120B, AD-120BBTDD-UK, AD-120C, AD-120CW, AD-120HY, AD-90, AD-90BA, AD-90BBT, AD-90BDD, AD-90DD, ADE-120, ADE-120B, ECO-120, ECO-120B, FI-100, FI-100AR, FI-100B, FI-100BBT-UK, FI-120, FI-120AR+DD, FI-120B, FI-120C, FI-120HY-CLINIC, FI-120W, FI-80, FI-80AR, FI-80BBT-UK, FI-80W, FI-E-100, LABP-1000, LABP-1200, LABP-800, LAC-25, LAC-25MP, LAC-25MPP, LAC-55, LAC-55MP, LAC-55MPP, LC-25, MF-120		

motores

motorreductores

para lavavajillas



1

código	601662	referencia	12023304 Z315001 Z315006
---------------	--------	-------------------	--------------------------------

descripción motorreductor C.M.E tipo 71 B 6/4 0,18/0,25W 230V 50Hz fases 1 1380rev/min MI 50 transmisión 60/1 para lavavajillas

Para modelos: ECO-280D, ECO-280I, ECO-370D, ECO-370I, ECO-460D, ECO-460I, ECO-550D, ECO-550I, FI-280D, FI-280I, FI-370D, FI-370I, FI-460D, FI-460I, FI-550D, FI-550I

bombas

bombas de lavado y aclarado

FIR

bombas



1

código	499353	referencia	12024782 T360715 T360715000
descripción	bomba entrada \varnothing 30mm salida \varnothing 26mm tipo 5213E2451 230V 50Hz fases 1 0.22kW 0.1PS L 190mm dirección de rodadura izquierdo condensador 5 μ F FIR		
Para modelos:	APE-201, APE-202, APG-201, APG-202, HEP-10-21, HEP-20-21, HGP-10-21, HGP-20-21, VPE-102, VPE-201, VPE-202, VPG-102, VPG-201, VPG-202		

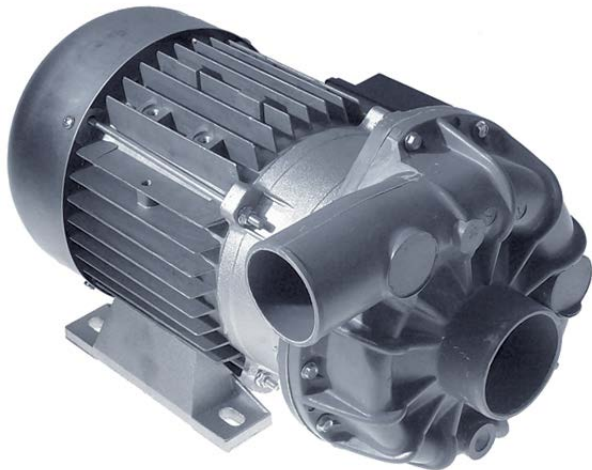

1



código	500705	referencia	12024812 Z101001
descripción	bomba entrada \varnothing 63mm salida \varnothing 53mm tipo 1243 230/400V 50Hz fases 3 2.39kW 3.2PS L 363mm dirección de rodadura izquierdo FIR		
Para modelos:	ECO-1600, ECO-2300, ECO-280D, ECO-280I, ECO-3000, ECO-370D, ECO-370I, ECO-460D, ECO-460I, ECO-550D, ECO-550I, FI-1600, FI-2300, FI-280D, FI-280I, FI-3000, FI-370D, FI-370I, FI-460D, FI-460I, FI-550D, FI-550I		
repuestos para	500705		
	código	510357	referencia —
	rotor \varnothing 124mm H 34/16mm rosca M8R palas 6		

HANNING

bombas



1

código	499166	referencia	12024233
descripción	bomba entrada \varnothing 28mm salida \varnothing 26mm tipo UP60-414 220-240V 50/60Hz fases 1 0.25kW L 190mm dirección de rodadura derecho condensador 5 μ F HANNING p máx. 1bar Qmáx. 150l/min		
Para modelos:	AD-125, AD-125HRS, AD-125-SOFT, AD-45BBT, AD-48HY, AD-505, AD-64BBT, AD-64BTDD, AD-64HY, COP-173, COP-173B, COP-173BDD, COP-173DD, COP-173HRS, COP-173HRSDD, COP-173-SOFT, COP-174, COP-174B, COP-174BDD, COP-174DD, COP-174HRS, COP-174HRSDD, COP-174W, COP-174WHRS, COP-503, COP-503B, COP-503BDD, COP-503DD, COP-503-SOFT, COP-504, COP-504B, COP-504BDD, COP-504DD, COP-504W, EASY-500HPWBDD, FI-30B-BT-UK, FI-48B-BT-UK, FI-48HY-CLINIC, FI-64B-BT-UK, FI-64HY-CLINIC		
repuestos para	499166		
	código	365017	referencia —
	condensador de servicio capacidad 5 μ F 450V tolerancia 5% 50/60Hz temperatura ambiente máx. -25 a +85°C \varnothing 28mm L 54mm M8 plástico empalme conector Faston 6,3mm 16.10.08 protección		
	código	507558	referencia —
	sello mecánico para árbol \varnothing 7mm altura contraarandela 5mm int. \varnothing 6.75mm \varnothing ext. 20mm montaje \varnothing contraarandela 18,5/ arandela fricción 20mm		
	código	532644	referencia —
	junta tórica EPDM espesor 3mm int. \varnothing 78mm UE 1 pzs		



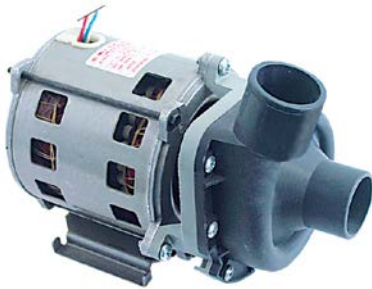

INSERT STAR

bombas



1

código	500321	referencia	12023429 Z401001
descripción	bomba entrada ø 38mm salida ø 38mm tipo 2/102FA10 230V 50/60Hz fases 1 0.26kW 0.35PS L 195mm dirección de rodadura derecho condensador 6µF INSERTSTAR		
Para modelos:	AD-120BTTDD-UK, AD-120HY, AD-15, AD-15D, AD-20C-UK, AD-21, AD-21B, AD-21BDD, AD-21C, AD-21D, AD-21DD, AD-21W, AD-90BBT, ADE-120, ADE-120B, CO-350, CO-350-B, CO-350-B-DD, CO-350-COLD, CO-350-COLD-B, CO-350-COLD-B-DD, CO-350-COLD-DD, CO-350-DD, CO-352-COLD, CO-352-COLD-B, CO-352-COLD-B-DD, CO-352-COLD-DD, CO-400, CO-400-B, CO-400-B-DD, CO-400-COLD, CO-400-COLD-B, CO-400-COLD-B-DD, CO-400-COLD-DD, CO-400-DD, CO-400-SOFT, CO-402-COLD, CO-402-COLD-B, CO-402-COLD-B-DD, CO-402-COLD-DD, CO-402W, ECO-120, ECO-1200, ECO-120B, ECO-160, ECO-160D, ECO-160I, ECO-200, ECO-200D, ECO-200H...(Otros modelos se puede ver en la tienda web)		
repuestos para	500321		
	código	504578	referencia —
	junta tórica EPDM espesor 3.53mm int.ø 94.84mm UE 1 pzs		
	código	510693	referencia 12018735 Z201081
	sello mecánico para árbol ø 12mm anillo deslizante ø ext. 24mm anillo deslizante H 15.5mm anillo deslizante ø int. 11mm contraarandela montaje ø 24mm altura contraarandela 8mm contraarandela ø int. 13.5mm		
accesorios para	500321		
	código	365093	referencia 12024346 V817100
	condensador de servicio capacidad 6µF 400V tolerancia 5% 50/60Hz temperatura ambiente máx. -25 a + 85°C ø 31.5mm L 55mm M8 plástico empalme conector Faston 6,3mm protección		







1

código	501562	referencia	12043287
descripción	bomba entrada ø 38mm salida ø 38mm tipo 2/123 FA-22 230V 50Hz fases 1 0.59kW 0.8PS dirección de rodadura derecho condensador 10µF INSERTSTAR		
Para modelos:	AD-120C, AD-120HY, AD-125, AD-125HRS, AD-125-SOFT, AD-505, AD-505-SOFT, AD-64BTDD, CO-110, CO-110B, CO-110BDD, CO-110DD, CO-112, CO-112B, CO-112BDD, CO-112DD, CO-170, CO-170B, CO-170BDD, CO-170DD, CO-170HRS, CO-170HRSDD, CO-170HRS-SOFT, CO-170-SOFT, CO-172, CO-172B, CO-172BDD, CO-172DD, CO-500, CO-500B, CO-500BDD, CO-500DD, CO-501, CO-501B, CO-501BDD, CO-501DD, CO-501-SOFT, CO-502B, CO-502BDD, CO-502DD, COP-173, COP-173B, COP-173BDD, COP-173DD, COP-173HRS, COP-173HRSDD, COP-173-SOFT, COP-174, COP-174B, COP-174BDD...(Otros modelos se puede ver en la tienda web)		



1

código	499075	referencia	12024270 Z203501 Z203511
descripción	bomba entrada ø 38mm salida ø 38mm tipo 2/123 FA31 230V 60Hz fases 1 0.59kW L 240mm dirección de rodadura derecho condensador 10µF INSERTSTAR		
Para modelos:	AD-120, AD-120B, AD-120C, AD-120CW, AD-48, AD-48W, AD-64, AD-64CW, AD-72, AD-72W, AD-90, AD-90BA, AD-90BDD, AD-90DD, ADE-120, ADE-120B, EASY-500, EASY-500B, EASY-500DD, EASY-500HP, EASY-500HPWBDD, ECO-120, ECO-1200, ECO-120B, ECO-160D, ECO-160I, ECO-200D, ECO-200HD, ECO-200HI, ECO-200I, ECO-370D, ECO-370I, ECO-550D, ECO-550I, FI-100, FI-100AR, FI-100B, FI-100BTT-UK, FI-120, FI-1200, FI-120AR+DD, FI-120B, FI-120C, FI-120HY-CLINIC, FI-120W, FI-160AR, FI-160D, FI-160I, FI-200AR, FI-200D...(Otros modelos se puede ver en la tienda web)		
repuestos para	499075		
	código	510693	referencia 12018735 Z201081
	sello mecánico para árbol ø 12mm anillo deslizante ø ext. 24mm anillo deslizante H 15.5mm anillo deslizante ø int. 11mm contraarandela montaje ø 24mm altura contraarandela 8mm contraarandela ø int. 13.5mm		
	código	521000	referencia 12019782 Z201085
	cubierta de bomba FAGOR entrada ø 38mm salida ø 38mm		
	código	532491	referencia —
	junta tórica EPDM espesor 3.53mm int.ø 120.2mm UE 1 pzs		
	código	650238	referencia —
	rotor ø 77mm H 32mm tipo bomba 2/123 FA31 soporte de eje ø 8mm dirección de rodadura derecho rosca M8L para INSERTSTAR árbol ø 12mm longitud árbol 26mm palas 6		
accesorios para	499075		
	código	365015	referencia 12024376 V321300
	condensador de servicio capacidad 10µF 400V tolerancia 5%Hz temperatura ambiente máx. -25 a + 85°C ø 35.5mm L 59mm M8 plástico empalme conector Faston 6,3mm protección		

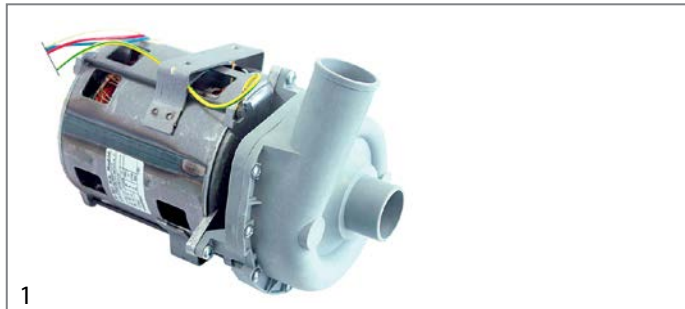

1

código	500320	referencia	12024265 Z201001 Z201011
descripción	bomba entrada ø 38mm salida ø 38mm tipo 2/123/FA30 230V 50Hz fases 1 0.59kW 0.8PS L 235mm dirección de rodadura derecho condensador 10µF INSERTSTAR		
Para modelos:	AD-120, AD-120B, AD-120BBTDD-UK, AD-120C, AD-120HY, AD-45BBT, AD-48, AD-48B, AD-48BDD, AD-48C, AD-48D, AD-48DD, AD-48HY, AD-64, AD-64B, AD-64BBT, AD-64BDD, AD-64BTDD, AD-64C, AD-64D, AD-64DD, AD-64HY, AD-72, AD-90, AD-90BA, AD-90BBT, AD-90BDD, AD-90DD, ADE-120, ADE-120B, EASY-500, EASY-500B, EASY-500DD, EASY-500HP, EASY-500HPWBDD, ECO-120, ECO-1200, ECO-120B, ECO-160, ECO-1600, ECO-160D, ECO-160I, ECO-200, ECO-200D, ECO-200H, ECO-200HD, ECO-200HI, ECO-200I, ECO-2300, ECO-3000...(Otros modelos se puede ver en la tienda web)		
repuestos para	500320		
	código	510693	referencia 12018735 Z201081
	sello mecánico para árbol ø 12mm anillo deslizando ø ext. 24mm anillo deslizando H 15.5mm anillo deslizando ø int. 11mm contraarandela montaje ø 24mm altura contraarandela 8mm contraarandela ø int. 13.5mm		
	código	521000	referencia 12019782 Z201085
	cubierta de bomba FAGOR entrada ø 38mm salida ø 38mm		
	código	521255	referencia 12018550 Z201082
	rotor ø 88mm H 33mm M8L tipo bomba 2/123/FA30 árbol ø 12mm		
	código	532491	referencia —
	junta tórica EPDM espesor 3.53mm int.ø 120.2mm UE 1 pzs		
accesorios para	500320		
	código	365015	referencia 12024376 V321300
	condensador de servicio capacidad 10µF 400V tolerancia 5%Hz temperatura ambiente máx. -25 a + 85°C ø 35.5mm L 59mm M8 plástico empalme conector Faston 6,3mm protección		
	código	551227	referencia —
	conector Faston hembra tamaño 6,3x0,8mm 1,0-2,5mm ² recto CuZn gal Sn T máx 110°C UE 10 pzs		

bombas de aumento de presión I



1

código	499155	referencia	12023344 Z209508
descripción	bomba entrada ø 1" F salida ø 1" F tipo PRISMA15 230V 50Hz 0.6kW L 400mm condensador 12µF		
Para modelos:	ECO-120, ECO-1200, FI-100, FI-120, FI-1200, FI-120W, FI-30, FI-30AR, FI-30AR+DD, FI-30-UK, FI-48, FI-48AR, FI-48B, FI-48B-BT-UK, FI-48C, FI-48D, FI-48HY-CLINIC, FI-48W, FI-50, FI-64, FI-64AR, FI-64B, FI-64B-BT-UK, FI-64C, FI-64D, FI-64HY-CLINIC, FI-64W, FI-72, FI-72AR, FI-72W, FI-900, MF-48, MF-64		



1

código	499073	referencia	12017575 12017826 12024708
descripción	bomba entrada ø 31 salida ø 27 tipo 887084885 230V 50Hz 0.75kW L 146mm condensador 2.5µF NIDEC		
Para modelos:	APE-061, APE-101, APE-102, APG-061, APG-101, APG-102, FI-30B-BT-UK, FI-48B-BT-UK, FI-48HY-CLINIC, FI-64B-BT-UK, FI-64HY-CLINIC, VPE-061, VPE-101		

bombas de salida

COPRECI



1

código	500322	referencia	12024273 Z220901
descripción	bomba de desagüe entrada ø 25mm salida ø 22mm 230V 30W 50Hz COPRECI		
Para modelos:	AD-20C-UK, AD-21B, AD-21BDD, AD-21C, AD-45BBT, AD-48B, AD-48BDD, AD-48C, AD-48HY, AD-64B, AD-64BBT, AD-64BDD, AD-64C, AD-64HY, FI-30, FI-30AR, FI-30AR+DD, FI-30B, FI-30B-BT-UK, FI-30-UK, FI-48, FI-48AR, FI-48B, FI-48B-BT-UK, FI-48C, FI-48D, FI-48HY-CLINIC, FI-48W, FI-64, FI-64AR, FI-64B, FI-64B-BT-UK, FI-64C, FI-64D, FI-64HY-CLINIC, FI-64W, GA-20, GA-20D, GA-40, GA-40D, HEM-10-21, HEM-20-21, HEP-10-21, HEP-20-21, HGP-10-21, HGP-20-21, HGV-10-21, HGV-20-21, LVC-21B, LVC-21C...(Otros modelos se puede ver en la tienda web)		



HANNING



1

código	500573	referencia	12029471 RT4400207P
descripción	bomba de desagüe 30W 4 piezas 230V entrada ø 24/30mm salida ø 24mm 50Hz HANNING tipo DPS25-032 1x bomba, 3x tapa		



1

código	501561	referencia	12094265
descripción	bomba de desagüe 38W 200-240V entrada ø 30mm salida ø 24mm 50/60Hz tipo DP25R-396 HANNING		
Para modelos:	AD-505, AD-505-SOFT, CO-350-B, CO-350-B-DD, CO-350-COLD-B, CO-350-COLD-B-DD, CO-352-COLD-B, CO-352-COLD-B-DD, CO-400-B, CO-400-B-DD, CO-400-COLD-B, CO-400-COLD-B-DD, CO-402-COLD-B, CO-402-COLD-B-DD, CO-402W, CO-500B, CO-500BDD, CO-501B, CO-501BDD, CO-502B, CO-502BDD, CO-502W, COP-503B, COP-503BDD, COP-504B, COP-504BDD, COP-504W, EASY-500B, EASY-500DD		



1

código	500737	referencia	12023456 Z711007
descripción	bomba de desagüe 95W 230V entrada ø 24mm salida ø 24mm 50Hz tipo BE38B5-017 HANNING		
Para modelos:	AD-120B, AD-120BBTDD-UK, AD-120C, AD-120HY, AD-125, AD-125HRS, AD-125-SOFT, AD-90BA, AD-90BBT, AD-90BDD, ADE-120B, CO-110B, CO-110BDD, CO-112B, CO-112BDD, CO-170B, CO-170BDD, CO-172B, CO-172BDD, COP-173B, COP-173BDD, COP-174B, COP-174BDD, ECO-120B, FI-100, FI-100AR, FI-100B, FI-100BBT-UK, FI-120B, FI-120C, FI-120HY-CLINIC, FI-80BBT-UK		

kits de servicio



1

código	500573	referencia	12029471 RT4400207P
descripción	bomba de desagüe 30W 4 piezas 230V entrada ø 24/30mm salida ø 24mm 50Hz HANNING tipo DPS25-032 1x bomba, 3x tapa		

accesorios

soportes



1

código	500735	referencia	12022664 Z430902
descripción	escuadra de sujeción para bomba de salida		
Para modelos:	AD-20C-UK, AD-21B, AD-21BDD, AD-21C, AD-21W, LVC-21B, LVC-21C, LVC-21W, LVR-20B, MF-21		



1

código	500736	referencia	12022443 Z220904
descripción	escuadra de sujeción para bomba de salida		
Para modelos:	AD-45BBT, AD-48B, AD-48BDD, AD-48C, AD-48HY, AD-48W, AD-64B, AD-64BBT, AD-64BDD, AD-64C, AD-64CW, AD-64HY, FI-30, FI-30AR, FI-30AR+DD, FI-30B, FI-30B-BT-UK, FI-30-UK, FI-48, FI-48AR, FI-48B, FI-48B-BT-UK, FI-48C, FI-48D, FI-48HY-CLINIC, FI-48W, FI-64, FI-64AR, FI-64B, FI-64B-BT-UK, FI-64C, FI-64D, FI-64HY-CLINIC, FI-64W, MF-48, MF-64		



bombas de aumento de presión II

accesorios

			
1			
código	365015	referencia	12024376 V321300
descripción	condensador de servicio capacidad 10µF 400V tolerancia 5%Hz temperatura ambiente máx. -25 a + 85°C ø 35.5mm L 59mm M8 plástico empalme conector Faston 6,3mm protección		
Para modelos:	AD-120, AD-120B, AD-120BBTDD-UK, AD-120C, AD-120CW, AD-120HY, AD-125, AD-125HRS, AD-125-SOFT, AD-45BBT, AD-48, AD-48B, AD-48BDD, AD-48C, AD-48D, AD-48DD, AD-48HY, AD-48W, AD-505, AD-505-SOFT, AD-64, AD-64B, AD-64BBT, AD-64BDD, AD-64BTDD, AD-64C, AD-64CW, AD-64D, AD-64DD, AD-64HY, AD-72, AD-72W, AD-90, AD-90BA, AD-90BBT, AD-90BDD, AD-90DD, ADE-120, ADE-120B, CO-110, CO-110B, CO-110BDD, CO-110DD, CO-112, CO-112B, CO-112BDD, CO-112DD, CO-142W, CO-142WDD, CO-170...(Otros modelos se puede ver en la tienda web)		

			
1			
código	365012	referencia	SAM4420032
descripción	condensador de servicio capacidad 6.3µF 450V tolerancia 5% 50Hz temperatura ambiente máx. -25 a + 85°C ø 30mm L 61mm M8 plástico empalme conector Faston 6,3mm protección		

			
1			
código	365020	referencia	12020898 R293000
descripción	condensador de servicio capacidad 14µF 400V tolerancia 5%Hz temperatura ambiente máx. -25 a + 85°C ø 35mm L 70mm M8 plástico empalme conector Faston 6,3mm protección		
Para modelos:	HCG-10-11, HCG-10-21, HCG-2-10-11, HCG-6-11, HCV-10-11, HCV-10-21, HCV-2-10-21, HCV-5-11, HCV-6-11, HE-5-11, HG-10-11, HG-10-21, HG-2-10-11, HMG-10-11, HMG-10-11UL, HMG-10-21, HMG-10-21UL, HMG-2-10-11, HMG-6-11, HVG-10-11, HVG-10-11UL, HVG-10-21, HVG-10-21UL, HVG-2-10-11, MFHVG-10-11, MFHVG-10-21		

			
1			
código	365012	referencia	SAM4420032
descripción	condensador de servicio capacidad 6.3µF 450V tolerancia 5% 50Hz temperatura ambiente máx. -25 a + 85°C ø 30mm L 61mm M8 plástico empalme conector Faston 6,3mm protección		

			
1			
código	365093	referencia	12024346 V817100
descripción	condensador de servicio capacidad 6µF 400V tolerancia 5% 50/60Hz temperatura ambiente máx. -25 a + 85°C ø 31.5mm L 55mm M8 plástico empalme conector Faston 6,3mm protección		
Para modelos:	AD-120BBTDD-UK, AD-120HY, AD-15, AD-15D, AD-20C-UK, AD-21, AD-21B, AD-21BDD, AD-21C, AD-21D, AD-21DD, AD-21W, AD-90BBT, ADE-120, ADE-120B, CO-350, CO-350-B, CO-350-B-DD, CO-350-COLD, CO-350-COLD-B, CO-350-COLD-B-DD, CO-350-COLD-DD, CO-350-DD, CO-352-COLD, CO-352-COLD-B, CO-352-COLD-B-DD, CO-352-COLD-DD, CO-400, CO-400-B, CO-400-B-DD, CO-400-COLD, CO-400-COLD-B, CO-400-COLD-B-DD, CO-400-COLD-DD, CO-400-DD, CO-400-SOFT, CO-402-COLD, CO-402-COLD-B, CO-402-COLD-B-DD, CO-402-COLD-DD, CO-402W, ECO-120, ECO-120B, ECO-160, ECO-160D, ECO-160L, ECO-200, ECO-200D, ECO-200H, ECO-200HD...(Otros modelos se puede ver en la tienda web)		

condensadores y filtros antiparasitarios

condensadores de servicio

plástico

			
1			
código	365015	referencia	12024376 V321300
descripción	condensador de servicio capacidad 10µF 400V tolerancia 5%Hz temperatura ambiente máx. -25 a + 85°C ø 35.5mm L 59mm M8 plástico empalme conector Faston 6,3mm protección		
Para modelos:	AD-120, AD-120B, AD-120BBTDD-UK, AD-120C, AD-120CW, AD-120HY, AD-125, AD-125HRS, AD-125-SOFT, AD-45BBT, AD-48, AD-48B, AD-48BDD, AD-48C, AD-48D, AD-48DD, AD-48HY, AD-48W, AD-505, AD-505-SOFT, AD-64, AD-64B, AD-64BBT, AD-64BDD, AD-64BTDD, AD-64C, AD-64CW, AD-64D, AD-64DD, AD-64HY, AD-72, AD-72W, AD-90, AD-90BA, AD-90BBT, AD-90BDD, AD-90DD, ADE-120, ADE-120B, CO-110, CO-110B, CO-110BDD, CO-110DD, CO-112, CO-112B, CO-112BDD, CO-112DD, CO-142W, CO-142WDD, CO-170...(Otros modelos se puede ver en la tienda web)		

metal

			
1			
código	365139	referencia	12032744 EU206002
descripción	condensador de servicio capacidad 10µF 450V tolerancia 5% 60Hz temperatura ambiente máx. -25 a +70°C ø 40mm L 83mm M8 aluminio empalme conector Faston 6,3mm C.87.8BF2 MKP protección		



fusibles

fusibles finos

componentes eléctricos



código	358671	referencia	12039844 R663101
descripción	fusible fino medida $\phi 5 \times 20 \text{mm}$ 1A rápido nominal 250V UE 10 pzs		
Para modelos:	HME-10-11, HME-10-21, HME-20-11, HME-20-21, HME-2-10-11, HME-2-20-11, HME-6-11, HMP-10-11, HMP-10-21, HMP-20-11, HMP-20-21, HMP-2-10-11, HMP-6-11		



código	358677	referencia	12024333 12035393 P184011 RT30190112
descripción	fusible fino medida $\phi 5 \times 20 \text{mm}$ 4A rápido nominal 250V UE 10 pzs		
Para modelos:	CE-15, CE-9, ECO-160, ECO-1600, ECO-160D, ECO-160I, ECO-200, ECO-200D, ECO-200H, ECO-200HD, ECO-200HI, ECO-200I, ECO-2300, ECO-280D, ECO-280I, ECO-3000, ECO-370D, ECO-370I, ECO-460D, ECO-460I, ECO-550D, ECO-550I, FF-35, FI-160, FI-1600, FI-160AR, FI-160D, FI-160I, FI-200, FI-200AR, FI-200D, FI-200H, FI-200HD, FI-200HI, FI-200I, FI-200W, FI-2300, FI-280D, FI-280I, FI-3000, FI-370D, FI-370I, FI-460D, FI-460I, FI-550D, FI-550I, GA-20, GA-40, HCV-10-11, HCV-10-21... (Otros modelos se puede ver en la tienda web)		



código	358603	referencia	12034888 RT30190120
descripción	fusible fino medida $\phi 5 \times 20 \text{mm}$ 2A retardado nominal 250V UE 10 pzs		



código	358792	referencia	12035115 RT40010225
descripción	fusible fino medida $\phi 6,3 \times 32 \text{mm}$ 10A retardado nominal 250V UE 10 pzs		



código	358791	referencia	12037374 RT40010224
descripción	fusible fino medida $\phi 6,3 \times 32 \text{mm}$ 6.3A retardado nominal 250V UE 10 pzs		

portafusibles



código	550536	referencia	12025158 R073005
descripción	portafusibles fusible adaptable $\phi 10 \times 38 \text{mm}$ 30A nominal 600V		
Para modelos:	ACE-061, ACE-101, ACE-102, ACE-201, ACE-202, ACG-061, ACG-101, ACG-102, ACG-201, ACG-202, AD-120, AD-120B, AD-120BTTDD-UK, AD-120C, AD-120CW, AD-120HY, AD-125, AD-125HRS, AD-125-SOFT, AD-90, AD-90BA, AD-90BBT, AD-90BDD, AD-90DD, ADE-120, ADE-120B, AE-061, AE-061W, AE-101, AE-101W, AE-102, AE-102W, AE-201, AE-202, AG-061, AG-061W, AG-101, AG-101W, AG-102, AG-102W, APE-061, APE-061W, APE-101, APE-101W, APE-102, APE-102W, APE-201, APE-202, APG-061, APG-061W... (Otros modelos se puede ver en la tienda web)		

fusibles de rosca

sistema D0 (NEOZED)



código	358043	referencia	12033846 RT30190401
descripción	fusible medida D01 16A nominal 250/400V E14 $\phi 11 \text{mm}$ L 36mm UE 10 pzs		



código	358047	referencia	12032709 RT30190405
descripción	fusible medida D02 63A nominal 250/400V E18 $\phi 15 \text{mm}$ L 36mm UE 10 pzs		

suplementos de ajuste (NEOZED)



código	358064	referencia	12037278 RT40011238
descripción	suplemento de ajuste medida D02 apto para 16A		



portafusibles

			
1			
código	358060	referencia	12032263 RT40011234
descripción	portafusibles fusible adaptable D02 3 polos nominal 400V		

			
1			
código	358061	referencia	12036497 RT40011235
descripción	portafusibles fusible adaptable D02 ø 25mm montaje ø 18mm nominal 400V L 30mm		

accesorios eléctricos

cables

accesorios

tubos flexibles protectores

JOHN GUEST

			
1			
código	550788	referencia	12008694 X033027
descripción	unión roscada int.ø 14mm para tubo de protección plástico UE 1 pzs rosca PG11		
Para modelos:	FE7-05-1C, FE7-05-2C, FE-710, FE7-10-2C, FE7-10-4C, FE-71-15, FE-720, FE9-05, FE9-05-1C, FE9-05-2C, FE9-05AD, FE9-05PLUS, FE9-05PLUS-S, FE9-05S, FE9-05S-1C, FE9-05S-2C, FE9-05S-AD, FE9-05USMC, FE9-10, FE9-10-2C, FE9-10-4C, FE9-10AD, FE9-10PLUS, FE-91-20, FE-920, FG-710, FG-720, FI-200W		

otros

			
1			
código	550787	referencia	11000146 3712300
descripción	tubo de protección int.ø 23mm ø ext. 28mm UE 1m plástico para cable		
Para modelos:	ECO-120, ECO-120B, ECO-160, ECO-160D, ECO-160I, ECO-200, ECO-200D, ECO-200H, ECO-200HD, ECO-200HI, ECO-200I, ECO-2700D, ECO-2700I, ECO-280D, ECO-280I, ECO-370D, ECO-370I, ECO-4000D, ECO-4000I, ECO-460D, ECO-460I, ECO-550D, ECO-550I, ECO-6000D, ECO-6000I, FE7-05-1C, FE7-05-2C, FE-710, FE7-10-2C, FE7-10-4C, FE-720, FE9-05, FE9-05-1C, FE9-05-2C, FE9-05AD, FE9-05PLUS, FE9-05PLUS-S, FE9-05S, FE9-05S-1C, FE9-05S-2C, FE9-05S-AD, FE9-05USMC, FE9-10, FE9-10-2C, FE9-10-4C, FE9-10AD, FE9-10PLUS, FI-160, FI-160AR, FI-160D...(Otros modelos se puede ver en la tienda web)		

pasacables

			
1			
código	551102	referencia	6003010082
descripción	boquilla pasacables int.ø 10mm montaje ø 12mm Neoprene -30 a +120°C UE 1 pzs		
Para modelos:	ATM-031, ATM-031-60Hz, ATM-051VCH, ATM-051VCH-60Hz, ATM-081VCH, ATM-081VCH-60Hz, ATM-101VCH, ATM-101VCH-60Hz, ATM-121VCH, ATM-121VCH-60Hz, ATM-121VCHP, ATM-161VCH		

			
1			
código	550311	referencia	12018128 N023064
descripción	boquilla pasacables int.ø 6mm montaje ø 9mm ø ext. 14mm Neoprene -30 a +90°C UE 10 pzs		
Para modelos:	ECO-120, ECO-120B, FI-100, FI-100AR, FI-100B, FI-120, FI-120B, FI-120W, FI-30, FI-48, FI-48B, FI-48W, FI-50, FI-64, FI-64B, FI-64W, FI-72, MF-120, MF-48, MF-64		

racores para cables

tuercas de fijación

			
1			
código	550974	referencia	12010063 R023025
descripción	tuerca rosca PG21 EC 34 plástico UE 1 pzs espesor 7.5mm montaje ømm ø cablemm		
Para modelos:	ACE-061, ACE-101, AE-061, AE-101, AE-101W, APE-061, APE-101, APE-101W, CE9-20, CE9-20AD, CE9-20PLUS, CE9-40, CE9-40AD, CE9-40PLUS, CE9-41, CGE9-41, COE-061, CPE7-05, CPE7-05NC, CPE9-05, CPE9-05AD, CPE9-05AD-S, CPE9-05NC, CPE9-05PLUS, CPE9-05PLUS-S, CPE9-05S, CPE9-05SNC, CPG9-05, CPG9-05NC, CPG9-05S, CPG9-05SNC, ECO-160, ECO-160D, ECO-160I, ECO-200, ECO-200D, ECO-200H, ECO-200HD, ECO-200HI, ECO-200I, ECO-2700D, ECO-2700I, ECO-280D, ECO-280I, ECO-370D, ECO-370I, ECO-4000D, ECO-4000I, ECO-460D, ECO-460I...(Otros modelos se puede ver en la tienda web)		

			
1			
código	550578	referencia	12009764 Q223016
descripción	tuerca rosca PG21 H 4.6mm EC 32 latón niquelado UE 1 pzs montaje ømm ø cablemm		
Para modelos:	ECO-120, ECO-120B, FI-100, FI-100AR, FI-100B, FI-120, FI-120B, FI-120W, FI-30, FI-48, FI-48B, FI-48W, FI-50, FI-64, FI-64B, FI-64W, FI-72, FI-80, FI-80W, LA-13M, LA-18MP, LA-AC-10M, LA-AC-10MA, LA-AC-10MP, LA-AC-13M, LA-AC-13MA, LA-AC-13MP, LA-AC-18M, LA-AC-18MA, LA-AC-18MP, LA-AC-25M, LA-AC-25MA, LA-AC-25MP, LA-E-10M, LA-E-10MA, LA-E-10MP, LA-E-13M, LA-E-13MA, LA-E-13MP, LA-E-18M, LA-E-18MA, LA-E-18MP, LA-E-25M, LA-E-25MA, LA-E-25MP, LA-V-10M, LA-V-10MP, LA-V-13M, LA-V-13MP, LA-V-18M...(Otros modelos se puede ver en la tienda web)		



compensadores de tracción



1

código	506222	referencia	12024230 Z203020
descripción	pasacables		
Para modelos:	AD-15, AD-15D, AD-20C-UK, AD-21, AD-21B, AD-21BDD, AD-21C, AD-21D, AD-21DD, AD-21W, AD-45BBT, AD-48, AD-48B, AD-48BDD, AD-48C, AD-48D, AD-48DD, AD-48HY, AD-48W, AD-505, AD-505-SOFT, AD-64, AD-64B, AD-64BBT, AD-64BDD, AD-64BTDD, AD-64C, AD-64D, AD-64DD, AD-64HY, AD-72, CG-210G, CG-310G, CO-350, CO-350-B, CO-350-B-DD, CO-350-COLD, CO-350-COLD-B, CO-350-COLD-B-DD, CO-350-COLD-DD, CO-350-DD, CO-352-COLD, CO-352-COLD-B, CO-352-COLD-B-DD, CO-352-COLD-DD, CO-400, CO-400-B, CO-400-B-DD, CO-400-COLD, CO-400-COLD-B...(Otros modelos se puede ver en la tienda web)		

cables de cinta plana

grupo 1



1

código	402970	referencia	12034267 EU41523
descripción	cable de cinta plana 10 polos L 1200mm tipo de conector 2 filas codificado UE 1m		

mazos de cables



1

código	691855	referencia	Z743001
descripción	mazo de cables para lavavajillas		
Para modelos:	FI-80		

terminales

clemas



1

código	550239	referencia	12025086 Z743006
descripción	bornera 12 polos sección nominal 16mm ² máx. 75A máx. 500V resis.a la temp. 150°C		
Para modelos:	AD-90, AD-90DD, ADE-120, ADE-120B, ECO-120, ECO-120B, FI-80, FI-80AR, FI-80BBT-UK, FI-80W		

regletas de bornes a tornillo/con contactos de enchufe



1

código	505212	referencia	12024110 Z603025
descripción	borne de conexión 2 polos máx. 20A máx. 600V empalme ø2,5mm ² / F6,3 resis.a la temp. 150°C sección nominal 4mm ²		
Para modelos:	AD-15, AD-15D, AD-20C-UK, AD-21, AD-21B, AD-21BDD, AD-21C, AD-21D, AD-21DD, AD-21W, AD-505, AD-505-SOFT, CG-210G, CG-310G, CO-500, CO-500B, CO-500BDD, CO-500DD, CO-501, CO-501B, CO-501BDD, CO-501DD, CO-501-SOFT, CO-502B, CO-502BDD, CO-502DD, CO-502W, COP-503, COP-503B, COP-503BDD, COP-503DD, COP-503-SOFT, COP-504, COP-504B, COP-504BDD, COP-504DD, COP-504W, LVC-12, LVC-15, LVC-15D, LVC-21, LVC-21B, LVC-21C, LVC-21D, LVC-21W, LVR-10, LVR-14, LVR-14D, LVR-20, LVR-20B...(Otros modelos se puede ver en la tienda web)		



1

código	550278	referencia	12024382 U183046
descripción	borne de conexión 3 polos máx. 40A máx. 400V empalme ø6mm ² / F6,3 resis.a la temp. 150°C sección nominal 6mm ²		
Para modelos:	BME6-05, BME7-05, BME9-05, BME9-05AD, BME9-05PLUS, BME9-05V-T, CE-410, CO-350, CO-350-B, CO-350-B-DD, CO-350-COLD, CO-350-COLD-B, CO-350-COLD-B-DD, CO-350-COLD-DD, CO-350-DD, CO-352-COLD, CO-352-COLD-B, CO-352-COLD-B-DD, CO-352-COLD-DD, CO-400, CO-400-B, CO-400-B-DD, CO-400-COLD, CO-400-COLD-B, CO-400-COLD-B-DD, CO-400-COLD-DD, CO-400-DD, CO-400-SOFT, CO-402-COLD, CO-402-COLD-B, CO-402-COLD-B-DD, CO-402-COLD-DD, CO-402W, CPG9-05, CPG9-05NC, CPG9-05S, CPG9-05SNC, CV6-20, CV6-40, FE-4, FG7-05-1C, FG7-05-2C, FG-710, FG7-10-2C, FG7-104C, FG7-10-4C, FG-720, FG9-05, FG9-05-1C, FG9-05-2C...(Otros modelos se puede ver en la tienda web)		



1

código	550411	referencia	12025183 12034943 EU220011 R253044
descripción	borne de conexión 6 polos máx. 40A máx. 450V empalme ø6mm ² / F6,3 resis.a la temp. 150°C sección nominal 6mm ²		
Para modelos:	AD-45BBT, AD-48, AD-48B, AD-48BDD, AD-48C, AD-48D, AD-48DD, AD-48HY, AD-48W, AD-505, AD-505-SOFT, AD-64, AD-64B, AD-64BBT, AD-64BDD, AD-64BTDD, AD-64C, AD-64CW, AD-64D, AD-64DD, AD-64HY, AD-72, AD-72W, BME7-10, BME9-10, BME9-10AD, BME9-10PLUS, BME9-10V-T, CE6-20, CE6-40, CE6-41, CE7-20, CE7-20Q, CE7-40, CE7-40Q, CE7-41, CE7-41Q, CGE6-41, CGE7-231, C19-20AD, C19-20PLUS, C19-40AD, C19-40PLUS, CMF6-05, CO-500, CO-500B, CO-500BDD, CO-500DD, CO-501, CO-501B...(Otros modelos se puede ver en la tienda web)		

bloques de bornes

WEIDMÜLLER

bornes de paso



código	550792	referencia	12024229 Z103029
descripción	borne seccionable 2.5mm ² para barra DIN 35mm gris 1 polos		
Para modelos:	ECO-160, ECO-1600, ECO-160D, ECO-160I, ECO-200, ECO-200D, ECO-200H, ECO-200HD, ECO-200HI, ECO-200I, ECO-2300, ECO-2700D, ECO-2700I, ECO-280D, ECO-280I, ECO-3000, ECO-370D, ECO-370I, ECO-4000D, ECO-4000I, ECO-460D, ECO-460I, ECO-550D, ECO-550I, ECO-6000D, ECO-6000I, FI-160, FI-1600, FI-160AR, FI-160D, FI-160I, FI-200, FI-200AR, FI-200D, FI-200H, FI-200HD, FI-200HI, FI-200I, FI-200W, FI-200WL, FI-200WR, FI-2300, FI-2700D, FI-2700I, FI-280D, FI-280I, FI-3000, FI-370D, FI-370I, FI-4000D...(Otros modelos se puede ver en la tienda web)		



código	551230	referencia	12024942 R143011
descripción	borne seccionable 70mm ² para barra DIN 35mm gris 1 polos		
Para modelos:	ACE-202, AE-202, APE-202, COE-202, ECO-280D, ECO-280I, ECO-370D, ECO-370I, ECO-460D, ECO-460I, ECO-550D, ECO-550I, FI-160, FI-160AR, FI-160D, FI-160I, FI-200, FI-200AR, FI-200D, FI-200H, FI-200HD, FI-200HI, FI-200I, FI-200W, FI-200WL, FI-200WR, FI-2700D, FI-2700I, FI-280D, FI-280I, FI-370D, FI-370I, FI-4000D, FI-4000I, FI-460D, FI-460I, FI-550D, FI-550I, FI-6000D, FI-6000I, HEI-20-21, HEM-20-21, HEP-20-21, HME-20-21, HME-2-20-11, HMM-20-21, HMM-20-21UL, HMM-40-11-USMC, HMP-20-21, VE-202...(Otros modelos se puede ver en la tienda web)		

accesorios



código	550789	referencia	12024199 Z263303
descripción	borne seccionable gris para barra DIN 35mm		
Para modelos:	ACG-061, ACG-101, ACG-102, ACG-201, ACG-202, AD-125, AD-125HRS, AD-125-SOFT, AG-061, AG-061W, AG-101, AG-101W, AG-102, AG-102W, AG-201, AG-202, APG-061, APG-061W, APG-101, APG-101W, APG-102, APG-102W, APG-201, APG-202, CE6-20, CE6-40, CE6-41, CE7-20, CE7-20Q, CE7-40, CE7-40Q, CE7-41, CE9-20, CE9-20AD, CE9-20PLUS, CGE6-41, CGE7-211, CGE7-41, CGE7-41H, CGE9-11, CGE9-41, CGE9-41AD, CGE9-41PLUS, CO-110, CO-110B, CO-110BDD, CO-110DD, CO-112, CO-112B, CO-112BDD...(Otros modelos se puede ver en la tienda web)		

WIELAND

bloques de bornes tipo 9700A



código	550374	referencia	12025191 12035926 RT40011250 Z683097
descripción	borne seccionable WIELAND tipo 9700A/10 S35 1,5-16mm ² riel de sombrero 35mm azul An 10mm L 49mm		
Para modelos:	AD-120, AD-120B, AD-120BBTDD-UK, AD-120C, AD-120HY, AD-90, AD-90BA, AD-90BBT, AD-90BDD, AD-90DD, ADE-120, ADE-120B, CE6-20, CE6-40, CE6-41, CE7-41, CE9-40, FE9-05, FE9-05-1C, FE9-05-2C, FE9-05AD, FE9-05PLUS, FE9-05PLUS-S, FE9-05S, FE9-05S-1C, FE9-05S-2C, FE9-05S-AD, FE9-05USMC, FE9-10, FE9-10-2C, FE9-10-4C, FE9-10AD, FE9-10PLUS, FE-920, FI-100, FI-100AR, FI-100B, FI-100BBT-UK, FI-120, FI-1200, FI-120AR+DD, FI-120B, FI-120C, FI-120HY-CLINIC, FI-120W, FI-80BBT-UK, FI-80W, FI-900, FI-E-100, FTE9-10L...(Otros modelos se puede ver en la tienda web)		





código	550373	referencia	12025214 12035988 RT40011202 Z683069
descripción	borne seccionable WIELAND tipo 9700A/10 S35 1,5-16mm ² riel de sombrero 35mm gris An 10mm L 49mm		
Para modelos:	AD-120, AD-120B, AD-120BBTDD-UK, AD-120C, AD-120HY, AD-90, AD-90BA, AD-90BBT, AD-90BDD, AD-90DD, ADE-120, ADE-120B, CE-410, CE9-40, CE9-41, CE9-41AD, CE9-41PLUS, FE9-05, FE9-05-1C, FE9-05-2C, FE9-05AD, FE9-05PLUS, FE9-05PLUS-S, FE9-05S, FE9-05S-1C, FE9-05S-2C, FE9-05S-AD, FE9-05USMC, FE9-10, FE9-10-2C, FE9-10-4C, FE9-10AD, FE9-10PLUS, FE-920, FI-100, FI-100AR, FI-100B, FI-100BBT-UK, FI-120, FI-1200, FI-120AR+DD, FI-120B, FI-120C, FI-120HY-CLINIC, FI-120W, FI-650R, FI-80BBT-UK, FI-80W, FI-900, FI-E-100...(Otros modelos se puede ver en la tienda web)		



código	550375	referencia	12023727 Z683070
descripción	borne seccionable WIELAND tipo 9700A/10 SL2 S35 1,5-16mm ² riel de sombrero 35mm amarillo/verde An 10mm L 53mm		
Para modelos:	AD-120, AD-120B, AD-120BBTDD-UK, AD-120C, AD-120CW, AD-120HY, AD-90, AD-90BA, AD-90BBT, AD-90BDD, AD-90DD, ADE-120, ADE-120B, CE-410, CE9-40, FE9-05, FE9-05-1C, FE9-05-2C, FE9-05AD, FE9-05PLUS, FE9-05PLUS-S, FE9-05S, FE9-05S-1C, FE9-05S-2C, FE9-05S-AD, FE9-05USMC, FE9-10, FE9-10-2C, FE9-10-4C, FE9-10AD, FE9-10PLUS, FE-920, FI-100, FI-100AR, FI-100B, FI-100BBT-UK, FI-120, FI-1200, FI-120AR+DD, FI-120B, FI-120C, FI-120HY-CLINIC, FI-120W, FI-650R, FI-80BBT-UK, FI-80W, FI-900, FI-E-100, FTE9-10L, FTE9-10L+R...(Otros modelos se puede ver en la tienda web)		



			
1			
código	550378	referencia	12033543 RT40011233
descripción	borne seccionable WIELAND tipo 9700A/16 SL2 S35 2,5-35mm ² riel de sombrero 35mm amarillo/verde An 16mm L 53mm		

			
1			
código	550381	referencia	12023373 P453025
descripción	borne seccionable WIELAND tipo 9700A/8 S35 1,0-10mm ² riel de sombrero 35mm gris An 8mm L 46.6mm		
Para modelos:	ACE-061, AD-125, AD-125HRS, AD-125-SOFT, AE-061, AE-061W, APE-061, APE-061W, CE6-20, CE6-40, CE6-41, CE7-20, CE7-20Q, CE7-40, CE7-40Q, CE7-41, CE9-20, CE9-20AD, CE9-20PLUS, CGE6-41, CGE7-208, CGE7-41, CGE7-41H, CGE9-11, CGE9-41, CGE9-41AD, CGE9-41PLUS, CO-110, CO-110B, CO-110BDD, CO-110DD, CO-112, CO-112B, CO-112BDD, CO-112DD, CO-142W, CO-142WDD, CO-170, CO-170B, CO-170BDD, CO-170DD, CO-170HRS, CO-170HRSDD, CO-170HRS-SOFT, CO-170-SOFT, CO-172, CO-172B, CO-172BDD, CO-172DD, COE-061...(Otros modelos se puede ver en la tienda web)		

accesorios

rótulos

			
1			
código	505000	referencia	12017607 12023957 Z213005 Z743005
descripción	placa de denominación R/S/T/N		
Para modelos:	AD-45BBT, AD-48, AD-48B, AD-48BDD, AD-48C, AD-48D, AD-48DD, AD-48HY, AD-48W, AD-64, AD-64B, AD-64BBT, AD-64BDD, AD-64BTDD, AD-64C, AD-64CW, AD-64D, AD-64DD, AD-64HY, AD-72, AD-72W, ECO-120, ECO-120B, FI-48, FI-48AR, FI-48B, FI-48B-BT-UK, FI-48C, FI-48D, FI-48HY-CLINIC, FI-48W, FI-50, FI-60DD, FI-64, FI-64AR, FI-64B, FI-64B-BT-UK, FI-64C, FI-64D, FI-64HY-CLINIC, FI-64W, FI-72, FI-72AR, FI-72W, FI-80, FI-80W, MF-48, MF-64		

barras DIN

			
1			
código	551017	referencia	12022603 Z103084
descripción	carril DIN An 35mm L 138mm dist. del agujero 118mm		
Para modelos:	COE-102, ECO-1600, ECO-2300, ECO-3000, FI-1600, FI-2300, FI-3000, FI-48, FI-48B, FI-48W, FI-50, FI-64, FI-64B, FI-64W, FI-72, HEI-10-21, HEM-10-11, HEM-10-21, HEM-20-11, HEM-6-11, HEP-10-11, HEP-10-21, HEP-20-11, HEP-6-11, HGC-10-21, HGP-10-21, HGV-10-21, HME-10-11, HME-10-21, HME-20-11, HME-2-10-11, HME-6-11, HMM-10-11, HMM-10-11UL, HMM-10-21, HMM-10-21UL, HMM-20-11, HMM-20-11UL, HMM-2-10-11, HMM-6-11, HMM-6-11UL, HMP-10-11, HMP-10-21, HMP-20-11, HMP-2-10-11, HMP-6-11, LC-AC-10, LC-AC-10A, LC-AC-14, LC-AC-14A...(Otros modelos se puede ver en la tienda web)		

			
1			
código	551016	referencia	12022790 Z123018
descripción	carril DIN An 35mm L 55mm dist. del agujero 35mm		
Para modelos:	CE6-41, CE7-41, CGE6-41, CGE7-220, CGE7-41, CGE7-41H, CMF6-05, COE-102, COE-202, CPE6-05, ECO-1600, ECO-2300, ECO-3000, FE6-05, FE6-05TE, FE6-10, FE6-10TE, FI-1600, FI-2300, FI-30, FI-3000, FI-30AR+DD, FI-30B-BT-UK, FI-30-UK, FI-48, FI-48B, FI-48B-BT-UK, FI-48D, FI-48HY-CLINIC, FI-48W, FI-50, FI-64W, FTE6-05L, FTE6-05R, FTE6-10L, FTE6-10L+R, FTE6-10R, FTE7-05, FTE7-05L, FTE7-05R, FTE7-10, FTE7-10L, FTE7-10L+R, FTE7-10R, FTE9-05L, FTE9-05L-AD, FTE9-05PLUS-CL, FTE9-05PLUS-CR, FTE9-05PLUS-L, FTE9-05PLUS-R...(Otros modelos se puede ver en la tienda web)		

			
1			
código	551018	referencia	12022528 Z103083
descripción	carril DIN An 35mm L 72mm dist. del agujero 52mm		
Para modelos:	ACE-061, ACE-101, ACE-102, ACE-201, ACE-202, AD-120, AD-120B, AD-120BBTDD-UK, AD-120C, AD-120CW, AD-120HY, AD-90, AD-90BA, AD-90BBT, AD-90BDD, AD-90DD, ADE-120, ADE-120B, AE-061, AE-101, AE-102, AE-201, AE-202, APE-061, APE-101, APE-102, APE-201, APE-202, CE6-20, CE6-40, CE6-41, CE7-20, CE7-20Q, CE7-40, CE7-40Q, CE7-41, CE7-41Q, CE9-20, CE9-40, CGE6-41, CGE7-207, CGE7-41, CGE7-41H, ECO-120, ECO-120B, ECO-1600, ECO-2300, ECO-3000, FF-35, FI-100...(Otros modelos se puede ver en la tienda web)		

cadenas

elementos de unión

			
1			
código	693276	referencia	12023767 Z105012
descripción	elemento de empalme simple DIN/ISO 08 B-1 división 1/2" eslabones 1 L 23mm anchura interior 11.8mm rodilloø 4.3mm metal		
Para modelos:	ECO-160, ECO-1600, ECO-160D, ECO-160L, ECO-200, ECO-200D, ECO-200H, ECO-200HD, ECO-200HI, ECO-200L, ECO-2300, ECO-2700D, ECO-2700L, ECO-280D, ECO-280L, ECO-3000, ECO-370D, ECO-370L, ECO-4000D, ECO-4000L, ECO-460D, ECO-460L, ECO-550D, ECO-550L, ECO-6000D, ECO-6000L, FI-160, FI-1600, FI-160AR, FI-160D, FI-160L, FI-200, FI-200AR, FI-200D, FI-200H, FI-200HD, FI-200HI, FI-200L, FI-200W, FI-200WL, FI-200WR, FI-2300, FI-2700D, FI-2700L, FI-280D, FI-280L, FI-3000, FI-370D, FI-370L, FI-4000D...(Otros modelos se puede ver en la tienda web)		



unidades de infusión			
juntas pra portafiltro			
juntas tóricas			
			
1			
código	510409	referencia	12010040 Q307044
descripción	junta tórica EPDM espesor 5.34mm int.ø 56.52mm UE 1 pzs		
Para modelos:	ECO-160, ECO-1600, ECO-160D, ECO-160I, ECO-200, ECO-200D, ECO-200H, ECO-200HD, ECO-200HI, ECO-200I, ECO-2300, ECO-2700D, ECO-2700I, ECO-280D, ECO-280I, ECO-3000, ECO-370D, ECO-370I, ECO-4000D, ECO-4000I, ECO-460D, ECO-460I, ECO-550D, ECO-550I, ECO-6000D, ECO-6000I, FI-160, FI-1600, FI-160AR, FI-160D, FI-160I, FI-200, FI-200AR, FI-200D, FI-200H, FI-200HD, FI-200HI, FI-200I, FI-200W, FI-200WL, FI-200WR, FI-2300, FI-2700D, FI-2700I, FI-280D, FI-280I, FI-3000, FI-370D, FI-370I, FI-4000D...(Otros modelos se puede ver en la tienda web)		

sistema de limpieza			
boquillas			
			
1			
código	505230	referencia	12017281 Z651931
descripción	boquilla de aclarado H 12mm rosca M10x1 EC 14 agujero ø 1.6mm		
Para modelos:	FI-300B, FI-300R, FI-650R, HCV-10-11, HCV-10-21, HCV-2-10-21, HCV-6-11, HEM-10-11, HEM-20-11, HEM-6-11, HEP-10-11, HEP-20-11, HEP-6-11, HME-10-11, HME-10-21, HME-20-11, HME-20-21, HME-2-10-11, HME-2-20-11, HME-6-11, HMM-10-11, HMM-10-11UL, HMM-10-21, HMM-10-21UL, HMM-20-11, HMM-20-11UL, HMM-20-21, HMM-20-21UL, HMM-2-10-11, HMM-2-20-11, HMM-40-11-USMC, HMM-6-11, HMM-6-11UL, HMP-10-11, HMP-10-21, HMP-20-11, HMP-20-21, HMP-2-10-11, HMP-2-20-11, HMP-6-11		

			
1			
código	505232	referencia	12021186 Z651932
descripción	difusor rotacional H 10.7mm ø 6mm 1.5mm H1 5mm		
Para modelos:	FI-300B, FI-300R, FI-650R, HCV-10-11, HCV-10-21, HCV-2-10-21, HCV-6-11, HEM-10-11, HEM-20-11, HEM-6-11, HEP-10-11, HEP-20-11, HEP-6-11, HME-10-11, HME-10-21, HME-20-11, HME-20-21, HME-2-10-11, HME-2-20-11, HME-6-11, HMM-10-11, HMM-10-11UL, HMM-10-21, HMM-10-21UL, HMM-20-11, HMM-20-11UL, HMM-20-21, HMM-20-21UL, HMM-2-10-11, HMM-2-20-11, HMM-40-11-USMC, HMM-6-11, HMM-6-11UL, HMP-10-11, HMP-10-21, HMP-20-11, HMP-20-21, HMP-2-10-11, HMP-2-20-11, HMP-6-11		

otros			
			
1			
código	696553	referencia	12017801 Z883001
descripción	resorte de compresión ø 7.5mm L 23mm espesor de hilo 0.7mm		
Para modelos:	ECO-280D, ECO-280I, ECO-370D, ECO-370I, ECO-460D, ECO-460I, ECO-550D, ECO-550I, FI-280D, FI-280I, FI-370D, FI-370I, FI-460D, FI-460I, FI-550D, FI-550I, HEI-10-11, HEI-20-11, HEI-6-11, HEM-10-11, HEM-20-11, HEM-6-11, HEP-10-11, HEP-20-11, HEP-6-11, HME-10-11, HME-10-21, HME-20-11, HME-20-21, HME-2-10-11, HME-2-20-11, HME-6-11, HMI-10-11, HMI-10-11UL, HMI-10-21, HMI-10-21UL, HMI-2-10-11, HMI-6-11, HMI-6-11UL, HMM-10-11, HMM-10-11UL, HMM-10-21, HMM-10-21UL, HMM-20-11, HMM-20-11UL, HMM-20-21, HMM-20-21UL, HMM-2-10-11, HMM-2-20-11, HMM-40-11-USMC...(Otros modelos se puede ver en la tienda web)		

			
1			
código	696427	referencia	12009970 Q222011
descripción	tuerca de remache rosca M5 DN 4mm L 12mm inox UE 1 pzs ø 7mm EC 6		
Para modelos:	ACE-061, ACE-101, ACE-102, ACE-201, ACE-202, ACG-061, ACG-101, ACG-102, ACG-201, ACG-202, AD-45BBT, AD-48HY, AD-64BBT, AD-64BTDD, AD-64HY, AE-061, AE-061W, AE-101, AE-101W, AE-102, AE-102W, AE-201, AE-202, AG-061, AG-061W, AG-101, AG-101W, AG-102, AG-102W, AG-201, AG-202, APE-061, APE-061W, APE-101, APE-101W, APE-102, APE-102W, APE-201, APE-202, APG-061, APG-061W, APG-101, APG-101W, APG-102, APG-102W, APG-201, APG-202, CE9-40, CE9-41, CG-2000...(Otros modelos se puede ver en la tienda web)		

para lavavajillas			
componentes de salida/aspiración			
FAGOR			
cuerpo de salida/aspiración			
			
1			
código	519617	referencia	12023627 Z330787000
descripción	cuerpo de aspiración ø ext. 48mm H 49mm int.ø 30mm		
Para modelos:	ECO-160D, ECO-160I, ECO-200D, ECO-200HD, ECO-200HI, ECO-200I, ECO-280D, ECO-280I, ECO-370D, ECO-370I, ECO-460D, ECO-460I, ECO-550D, ECO-550I, FI-160AR, FI-160D, FI-160I, FI-200AR, FI-200D, FI-200HD, FI-200HI, FI-200I, FI-200WL, FI-200WR, FI-280D, FI-280I, FI-370D, FI-370I, FI-460D, FI-460I, FI-550D, FI-550I		

			
1			
código	524780	referencia	12025261 Z710903
descripción	cuerpo de aspiración rosca 1½" ø ext. 60mm H 42mm tubo ø 38mm		
Para modelos:	AD-120, AD-120B, AD-120BBTDD-UK, AD-120C, AD-120CW, AD-120HY, AD-90, AD-90BA, AD-90BBT, AD-90BDD, AD-90DD, ADE-120, ADE-120B, ECO-120, ECO-120B, ECO-160, ECO-160D, ECO-160I, ECO-200, ECO-200D, ECO-200H, ECO-200HD, ECO-200HI, ECO-200I, ECO-370D, ECO-370I, ECO-550D, ECO-550I, FI-100, FI-100AR, FI-100B, FI-100BBT-UK, FI-120, FI-120AR+DD, FI-120B, FI-120C, FI-120HY-CLINIC, FI-120W, FI-160, FI-160AR, FI-160D, FI-160I, FI-200, FI-200AR, FI-200D, FI-200H, FI-200HD, FI-200HI, FI-200I, FI-200WL...(Otros modelos se puede ver en la tienda web)		

componentes mecánicos y accesorios aparatos



1

código	505160	referencia	12025225 Z600905
descripción	cuerpo de aspiración rosca 1½" ø ext. 71mm int.ø 36mm		
Para modelos:	ECO-1200, ECO-2700D, ECO-2700I, ECO-280D, ECO-280I, ECO-3000, ECO-370D, ECO-370I, ECO-4000D, ECO-4000I, ECO-460D, ECO-460I, ECO-550D, ECO-550I, ECO-6000D, ECO-6000I, FI-1200, FI-2700D, FI-2700I, FI-280D, FI-280I, FI-370D, FI-370I, FI-4000D, FI-4000I, FI-460D, FI-460I, FI-550D, FI-550I, FI-6000D, FI-6000I, FI-900		



1

código	505162	referencia	12025238 Z602101
descripción	empalme de desagüe ø ext. 45/27mm int.ø 21/18mm		
Para modelos:	ECO-1200, ECO-1600, ECO-2300, ECO-2700D, ECO-2700I, ECO-280D, ECO-280I, ECO-3000, ECO-370D, ECO-370I, ECO-4000D, ECO-4000I, ECO-460D, ECO-460I, ECO-550D, ECO-550I, ECO-6000D, ECO-6000I, FI-1200, FI-1600, FI-2300, FI-2700D, FI-2700I, FI-280D, FI-280I, FI-3000, FI-300R, FI-370D, FI-370I, FI-4000D, FI-4000I, FI-460D, FI-460I, FI-550D, FI-550I, FI-6000D, FI-6000I, FI-650R, FI-900		



1

código	515000	referencia	12037642 6003010062
descripción	empalme de desagüe para mesas frías rosca 1/2" int.ø 146mm L 93.5mm		
Para modelos:	ADMFCN-135, ADMFCN-180, ADMFCN-225, ADMFCP-135, ADMFCP-180, ADMFCP-225, ADMFN-135, ADMFN-180, ADMFN-225, ADMFP-135, ADMFP-135-GR, ADMFP-135HD, ADMFP-135HH, ADMFP-135PC, ADMFP-180, ADMFP-180-GR, ADMFP-180HDD, ADMFP-180HHD, ADMFP-180HHH, ADMFP-180PC, ADMFP-225, ADMFP-225-GR, ADMFP-225HDDD, ADMFP-225HHDD, ADMFP-225HHHD, ADMFP-225HHH, ADMFP-225PC, ATA-061, ATA-061-60Hz, ATA-101, ATA-101-60Hz, ATM-051ECO, ATM-051VCH, ATM-051VCH-60Hz, ATM-081VCH, ATM-081VCH-60Hz, ATM-101VCH, ATM-101VCH-60Hz, ATM-121VCH, ATM-121VCH-60Hz, ATM-121VCHP, ATM-161VCH, MCP-135-AD, MCP-180-AD, MCP-225-AD, MEP-100, MEP-100G, MFP-135-AD, MFP-135-AD-2C, MFP-135-AD-4C...(Otros modelos se puede ver en la tienda web)		



1

código	505222	referencia	12009817 Q307026
descripción	junta cónico ø ext. 72mm int.ø 45mm		
Para modelos:	BMG-9045, ECO-1200, ECO-1600, ECO-2300, ECO-2700D, ECO-2700I, ECO-280D, ECO-280I, ECO-3000, ECO-370D, ECO-370I, ECO-4000D, ECO-4000I, ECO-460D, ECO-460I, ECO-550D, ECO-550I, ECO-6000D, ECO-6000I, FI-1200, FI-1600, FI-2300, FI-2700D, FI-2700I, FI-280D, FI-280I, FI-3000, FI-300B, FI-300R, FI-370D, FI-370I, FI-4000D, FI-4000I, FI-460D, FI-460I, FI-550D, FI-550I, FI-6000D, FI-6000I, FI-650R, FI-900		



1

código	505249	referencia	12009936 Q307011
descripción	junta ø ext. 56mm int.ø 39mm espesor 1mm UE 1 pzs		
Para modelos:	ECO-1600, ECO-2300, ECO-280D, ECO-280I, ECO-3000, ECO-370D, ECO-370I, ECO-460D, ECO-460I, ECO-550D, ECO-550I, FI-1600, FI-2300, FI-280D, FI-280I, FI-3000, FI-370D, FI-370I, FI-460D, FI-460I, FI-550D, FI-550I		



1

código	515018	referencia	12009947 Q307032
descripción	junta plana goma ø ext. 32mm int.ø 21mm espesor 3mm UE 1 pzs		
Para modelos:	AD-120, AD-120B, AD-120BBTDD-UK, AD-120C, AD-120CW, AD-120HY, AD-90, AD-90BA, AD-90BBT, AD-90BDD, AD-90DD, ADE-120, ADE-120B, BME7-05, BME7-10, BME9-05, BME9-05AD, BME9-05PLUS, BME9-05V-T, BME9-10, BME9-10AD, BME9-10PLUS, BME9-10V-T, BMG7-10, BMG9-05, BMG9-05V-T, BMG9-10, BMG9-10V-T, CO-142W, CO-142WDD, COP-174W, COP-174WHR, ECO-120, ECO-1200, ECO-120B, ECO-160, ECO-1600, ECO-160D, ECO-160I, ECO-200, ECO-200D, ECO-200H, ECO-200HD, ECO-200HI, ECO-200I, ECO-2300, ECO-2700D, ECO-2700I, ECO-280D, ECO-280I...(Otros modelos se puede ver en la tienda web)		



1

código	505161	referencia	12010028 Q307027
descripción	junta plana goma ø ext. 45mm int.ø 35mm espesor 2mm UE 1 pzs		
Para modelos:	BMG-9045, ECO-1200, ECO-1600, ECO-2300, ECO-2700D, ECO-2700I, ECO-280D, ECO-280I, ECO-3000, ECO-370D, ECO-370I, ECO-4000D, ECO-4000I, ECO-460D, ECO-460I, ECO-550D, ECO-550I, ECO-6000D, ECO-6000I, FI-1200, FI-1600, FI-2300, FI-2700D, FI-2700I, FI-280D, FI-280I, FI-3000, FI-300B, FI-300R, FI-370D, FI-370I, FI-4000D, FI-4000I, FI-460D, FI-460I, FI-550D, FI-550I, FI-6000D, FI-6000I, FI-650R, FI-900		





1

código	505224	referencia	12009960 Q307058
descripción	junta plana goma ø ext. 60mm int.ø 44mm espesor 2mm UE 1 pzs		
Para modelos:	AD-120, AD-120B, AD-120BBTDD-UK, AD-120C, AD-120CW, AD-120HY, AD-90, AD-90BA, AD-90BBT, AD-90BDD, AD-90DD, ADE-120, ADE-120B, ECO-120, ECO-120B, ECO-160, ECO-160D, ECO-160I, ECO-200, ECO-200D, ECO-200H, ECO-200HD, ECO-200HI, ECO-200I, ECO-370D, ECO-370I, ECO-550D, ECO-550I, FI-100, FI-100AR, FI-100B, FI-100BBT-UK, FI-120, FI-120AR+DD, FI-120B, FI-120C, FI-120HY-CLINIC, FI-120W, FI-160, FI-160AR, FI-160D, FI-160I, FI-200, FI-200AR, FI-200D, FI-200H, FI-200HD, FI-200HI, FI-200I, FI-200W...(Otros modelos se puede ver en la tienda web)		



			
1			
código	505223	referencia	12009939 Q307009
descripción	junta plana goma ø ext. 70mm int.ø 48mm espesor 1.5mm UE 1 pzs		
Para modelos:	BMG-9045, ECO-1200, ECO-1600, ECO-2300, ECO-2700D, ECO-2700I, ECO-280D, ECO-280I, ECO-3000, ECO-370D, ECO-370I, ECO-4000D, ECO-4000I, ECO-460D, ECO-460I, ECO-550D, ECO-550I, ECO-6000D, ECO-6000I, FI-1200, FI-1600, FI-2300, FI-2700D, FI-2700I, FI-280D, FI-280I, FI-3000, FI-300B, FI-300R, FI-370D, FI-370I, FI-4000D, FI-4000I, FI-460D, FI-460I, FI-550D, FI-550I, FI-6000D, FI-6000I, FI-650R, FI-900		

			
1			
código	505194	referencia	12009937 Q307059
descripción	junta plana goma ø ext. 72mm int.ø 57mm espesor 2mm UE 1 pzs		
Para modelos:	AD-120, AD-120B, AD-120BBTDD-UK, AD-120C, AD-120CW, AD-120HY, AD-90, AD-90BA, AD-90BBT, AD-90BDD, AD-90DD, ADE-120, ADE-120B, ECO-120, ECO-120B, ECO-160, ECO-160D, ECO-160I, ECO-200, ECO-200D, ECO-200H, ECO-200HD, ECO-200HI, ECO-200I, ECO-2700D, ECO-2700I, ECO-280D, ECO-280I, ECO-370D, ECO-370I, ECO-4000D, ECO-4000I, ECO-460D, ECO-460I, ECO-550D, ECO-550I, ECO-6000D, ECO-6000I, FI-100, FI-100AR, FI-100B, FI-100BBT-UK, FI-120, FI-120AR+DD, FI-120B, FI-120C, FI-120HY-CLINIC, FI-120W, FI-160, FI-160AR...(Otros modelos se puede ver en la tienda web)		

			
1			
código	510832	referencia	12023571 Z310902
descripción	junta plana goma ø ext. 92mm int.ø 66mm espesor 2mm UE 1 pzs núm. Ref. 200906/33456		
Para modelos:	ECO-2700D, ECO-2700I, ECO-280D, ECO-280I, ECO-370D, ECO-370I, ECO-4000D, ECO-4000I, ECO-460D, ECO-460I, ECO-550D, ECO-550I, ECO-6000D, ECO-6000I, FI-2700D, FI-2700I, FI-280D, FI-280I, FI-370D, FI-370I, FI-4000D, FI-4000I, FI-460D, FI-460I, FI-550D, FI-550I, FI-6000D, FI-6000I		

			
1			
código	505259	referencia	12024339 Z102104
descripción	pileta de desagüe rosca 1½" H 42mm		
Para modelos:	ECO-1600, ECO-2300, ECO-2700D, ECO-2700I, ECO-280D, ECO-280I, ECO-3000, ECO-370D, ECO-370I, ECO-4000D, ECO-4000I, ECO-460D, ECO-460I, ECO-550D, ECO-550I, ECO-6000D, ECO-6000I, FI-1600, FI-2300, FI-2700D, FI-2700I, FI-280D, FI-280I, FI-3000, FI-370D, FI-370I, FI-4000D, FI-4000I, FI-460D, FI-460I, FI-550D, FI-550I, FI-6000D, FI-6000I		

			
1			
código	505193	referencia	12024234 Z710902
descripción	pileta de desagüe rosca 1¾" int.ø 44mm		
Para modelos:	AD-120, AD-120B, AD-120BBTDD-UK, AD-120C, AD-120CW, AD-120HY, AD-90, AD-90BA, AD-90BBT, AD-90BDD, AD-90DD, ADE-120, ADE-120B, ECO-120, ECO-120B, ECO-160, ECO-160D, ECO-160I, ECO-200, ECO-200D, ECO-200H, ECO-200HD, ECO-200HI, ECO-200I, ECO-2700D, ECO-2700I, ECO-280D, ECO-280I, ECO-370D, ECO-370I, ECO-4000D, ECO-4000I, ECO-460D, ECO-460I, ECO-550D, ECO-550I, ECO-6000D, ECO-6000I, FI-100, FI-100AR, FI-100B, FI-100BBT-UK, FI-120, FI-120AR+DD, FI-120B, FI-120C, FI-120HY-CLINIC, FI-120W, FI-160, FI-160AR...(Otros modelos se puede ver en la tienda web)		

			
1			
código	505156	referencia	12024315 Z702101
descripción	tuerca rosca 1½"		
Para modelos:	BMG-9045, ECO-1200, ECO-1600, ECO-2300, ECO-2700D, ECO-2700I, ECO-280D, ECO-280I, ECO-3000, ECO-370D, ECO-370I, ECO-4000D, ECO-4000I, ECO-460D, ECO-460I, ECO-550D, ECO-550I, ECO-6000D, ECO-6000I, FI-1200, FI-1600, FI-2300, FI-2700D, FI-2700I, FI-280D, FI-280I, FI-3000, FI-300B, FI-300R, FI-370D, FI-370I, FI-4000D, FI-4000I, FI-460D, FI-460I, FI-550D, FI-550I, FI-6000D, FI-6000I, FI-650R, FI-900		

			
1			
código	505163	referencia	12025276 Z602102
descripción	tuerca rosca 1½"		
Para modelos:	ECO-1200, ECO-1600, ECO-2300, ECO-2700D, ECO-2700I, ECO-280D, ECO-280I, ECO-3000, ECO-370D, ECO-370I, ECO-4000D, ECO-4000I, ECO-460D, ECO-460I, ECO-550D, ECO-550I, ECO-6000D, ECO-6000I, FI-1200, FI-1600, FI-2300, FI-2700D, FI-2700I, FI-280D, FI-280I, FI-3000, FI-300B, FI-300R, FI-370D, FI-370I, FI-4000D, FI-4000I, FI-460D, FI-460I, FI-550D, FI-550I, FI-6000D, FI-6000I, FI-650R, FI-900		



1

código	518080	referencia	12023537 Z710708
descripción	tuerca rosca 1½" EC 50 conducto espesor 15mm		
Para modelos:	AD-120, AD-120B, AD-120BBTDD-UK, AD-120C, AD-120CW, AD-120HY, AD-90, AD-90BA, AD-90BBT, AD-90BDD, AD-90DD, ADE-120, ADE-120B, ECO-120, ECO-120B, ECO-160, ECO-160D, ECO-160I, ECO-200, ECO-200D, ECO-200H, ECO-200HD, ECO-200HI, ECO-200I, ECO-370D, ECO-370I, ECO-550D, ECO-550I, FI-100, FI-100AR, FI-100B, FI-100BBT-UK, FI-120, FI-120AR+DD, FI-120B, FI-120C, FI-120HY-CLINIC, FI-120W, FI-160, FI-160AR, FI-160D, FI-160I, FI-200, FI-200AR, FI-200D, FI-200H, FI-200HD, FI-200HI, FI-200I, FI-200W...(Otros modelos se puede ver en la tienda web)		
repuestos para	518080		
	código	507425	referencia
			12018740 Z710707
	orificio de paso D1 ø 38mm D2 ø 45mm L 72mm ø int. 1 31mm ø int. 2 39mm		



1

código	505155	referencia	12009844 Q220001
descripción	tuerca rosca 1¾"		
Para modelos:	AD-120, AD-120B, AD-120BBTDD-UK, AD-120C, AD-120CW, AD-120HY, AD-90, AD-90BA, AD-90BBT, AD-90BDD, AD-90DD, ADE-120, ADE-120B, ECO-120, ECO-120B, ECO-160, ECO-160D, ECO-160I, ECO-200, ECO-200D, ECO-200H, ECO-200HD, ECO-200HI, ECO-200I, ECO-2700D, ECO-2700I, ECO-280D, ECO-280I, ECO-370D, ECO-370I, ECO-4000D, ECO-4000I, ECO-460D, ECO-460I, ECO-550D, ECO-550I, ECO-6000D, ECO-6000I, FI-100, FI-100AR, FI-100B, FI-100BBT-UK, FI-120, FI-120AR+DD, FI-120B, FI-120C, FI-120HY-CLINIC, FI-120W, FI-160, FI-160AR...(Otros modelos se puede ver en la tienda web)		



1

código	517432	referencia	12025231 Z310903
descripción	tuerca rosca 2¼"		
Para modelos:	ECO-2700D, ECO-2700I, ECO-280D, ECO-280I, ECO-370D, ECO-370I, ECO-4000D, ECO-4000I, ECO-460D, ECO-460I, ECO-550D, ECO-550I, ECO-6000D, ECO-6000I, FI-2700D, FI-2700I, FI-280D, FI-280I, FI-370D, FI-370I, FI-4000D, FI-4000I, FI-460D, FI-460I, FI-550D, FI-550I, FI-6000D, FI-6000I		



1

código	505244	referencia	12009949 Q228006
descripción	tuerca rosca M39x3		
Para modelos:	ECO-1600, ECO-2300, ECO-280D, ECO-280I, ECO-3000, ECO-370D, ECO-370I, ECO-460D, ECO-460I, ECO-550D, ECO-550I, FI-1600, FI-2300, FI-280D, FI-280I, FI-3000, FI-370D, FI-370I, FI-460D, FI-460I, FI-550D, FI-550I		



1

código	505159	referencia	12009815 Q228005
descripción	tuerca rosca M48x1,5		
Para modelos:	ECO-1200, ECO-2700D, ECO-2700I, ECO-280D, ECO-280I, ECO-370D, ECO-370I, ECO-4000D, ECO-4000I, ECO-460D, ECO-460I, ECO-550D, ECO-550I, ECO-6000D, ECO-6000I, FI-1200, FI-2700D, FI-2700I, FI-280D, FI-280I, FI-370D, FI-370I, FI-4000D, FI-4000I, FI-460D, FI-460I, FI-550D, FI-550I, FI-6000D, FI-6000I, FI-900		



1

código	505104	referencia	12024603 Z220902
descripción	unidad de desagüe ø ext. 32/56mm		
Para modelos:	AD-45BBT, AD-48B, AD-48BDD, AD-48C, AD-48HY, AD-48W, AD-64B, AD-64BBT, AD-64BDD, AD-64C, AD-64CW, AD-64HY, FI-30, FI-30AR, FI-30AR+DD, FI-30B, FI-30B-BT-UK, FI-30-UK, FI-48, FI-48AR, FI-48B, FI-48B-BT-UK, FI-48C, FI-48D, FI-48HY-CLINIC, FI-48W, FI-64, FI-64AR, FI-64B, FI-64B-BT-UK, FI-64C, FI-64D, FI-64HY-CLINIC, FI-64W, MF-48, MF-64		



1

código	505085 ¹	referencia	12024914 Z430901
descripción	unidad de desagüe tubo ø 32/38mm		
Para modelos:	AD-20C-UK, AD-21B, AD-21BDD, AD-21C, AD-21W, LVC-21B, LVC-21C, LVC-21W, LVR-20B, MF-21		

¹para bomba de desagüe



1

código	518609	referencia	12023618 Z310901
descripción	válvula de aspiración rosca 2¼" ø ext. 90mm H 131mm		
Para modelos:	ECO-2700D, ECO-2700I, ECO-280D, ECO-280I, ECO-370D, ECO-370I, ECO-4000D, ECO-4000I, ECO-460D, ECO-460I, ECO-550D, ECO-550I, ECO-6000D, ECO-6000I, FI-2700D, FI-2700I, FI-280D, FI-280I, FI-370D, FI-370I, FI-4000D, FI-4000I, FI-460D, FI-460I, FI-550D, FI-550I, FI-6000D, FI-6000I		



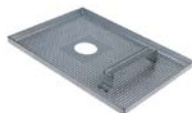

filtros			
			
1			
código	505012	referencia	12023617 Z400901
descripción	cubeta para filtro ø 158mm H 67mm		
Para modelos:	AD-15, AD-15D, AD-20C-UK, AD-21, AD-21B, AD-21BDD, AD-21C, AD-21D, AD-21DD, AD-21W, LVC-12, LVC-15, LVC-15D, LVC-21, LVC-21B, LVC-21C, LVC-21D, LVC-21W, LVR-10, LVR-14, LVR-14D, LVR-20, LVR-20B, LVR-20D, MF-21		

			
1			
código	505137	referencia	12003450 12038499 Z270801
descripción	filtro plano H 15mm L 315mm An 225mm		
Para modelos:	ECO-160, ECO-160D, ECO-160I, ECO-200, ECO-200D, ECO-200H, ECO-200HD, ECO-200HI, ECO-200I, FI-160, FI-160AR, FI-160D, FI-160I, FI-200, FI-200AR, FI-200D, FI-200H, FI-200HD, FI-200HI, FI-200I, FI-200W, FI-200WL, FI-200WR		

			
1			
código	505013	referencia	12024367 Z200906
descripción	cubeta para filtro ø 220mm H 67mm		
Para modelos:	AD-45BBT, AD-48, AD-48B, AD-48BDD, AD-48C, AD-48D, AD-48DD, AD-48HY, AD-48W, AD-64, AD-64B, AD-64BBT, AD-64BDD, AD-64BTDD, AD-64C, AD-64CW, AD-64D, AD-64DD, AD-64HY, AD-72, AD-72W, EASY-500, EASY-500B, EASY-500DD, EASY-500HP, EASY-500HPWBDD, FI-30, FI-30AR, FI-30AR+DD, FI-30B, FI-30B-BT-UK, FI-30-UK, FI-48, FI-48AR, FI-48B, FI-48B-BT-UK, FI-48C, FI-48D, FI-48HY-CLINIC, FI-48W, FI-50, FI-60DD, FI-64, FI-64AR, FI-64B, FI-64B-BT-UK, FI-64C, FI-64D, FI-64HY-CLINIC, FI-64W...(Otros modelos se puede ver en la tienda web)		

			
1			
código	505187	referencia	12003519 12038373 12Z7108010
descripción	filtro plano H 16mm L 630mm An 220mm		
Para modelos:	AD-120, AD-120B, AD-120BBTDD-UK, AD-120C, AD-120CW, AD-120HY, AD-90, AD-90BA, AD-90BBT, AD-90BDD, AD-90DD, ADE-120, ADE-120B, ECO-120, ECO-120B, FI-100, FI-100AR, FI-100B, FI-100BBT-UK, FI-120, FI-120AR+DD, FI-120B, FI-120C, FI-120HY-CLINIC, FI-120W, FI-80, FI-80AR, FI-80BBT-UK, FI-80W, FI-E-100, LABP-1000, LABP-1200, LABP-800, MF-120		

			
1			
código	505274	referencia	12025229 Z310906
descripción	filtro aspiración ø 88mm H 82mm		
Para modelos:	ECO-2700D, ECO-2700I, ECO-280D, ECO-280I, ECO-370D, ECO-370I, ECO-4000D, ECO-4000I, ECO-460D, ECO-460I, ECO-550D, ECO-550I, ECO-6000D, ECO-6000I, FI-2700D, FI-2700I, FI-280D, FI-280I, FI-370D, FI-370I, FI-4000D, FI-4000I, FI-460D, FI-460I, FI-550D, FI-550I, FI-6000D, FI-6000I		

			
1			
código	505142	referencia	12004370 12011137 12022559 12Z2108010
descripción	filtro plano H 8mm L 263mm An 200mm		
Para modelos:	AD-45BBT, AD-48, AD-48B, AD-48BDD, AD-48C, AD-48D, AD-48DD, AD-48HY, AD-48W, AD-64, AD-64B, AD-64BBT, AD-64BDD, AD-64BTDD, AD-64C, AD-64CW, AD-64D, AD-64DD, AD-64HY, AD-72, AD-72W, EASY-500HP, EASY-500HPWBDD, FI-48, FI-48AR, FI-48B, FI-48B-BT-UK, FI-48C, FI-48D, FI-48HY-CLINIC, FI-48W, FI-50, FI-64, FI-64AR, FI-64B, FI-64B-BT-UK, FI-64C, FI-64D, FI-64HY-CLINIC, FI-64W, FI-72, FI-72AR, FI-72W, MF-48, MF-64		

			
1			
código	505141	referencia	12003451 Z270803
descripción	filtro plano H 15mm L 315mm An 223mm		
Para modelos:	ECO-160, ECO-160D, ECO-160I, ECO-200, ECO-200D, ECO-200H, ECO-200HD, ECO-200HI, ECO-200I, FI-160, FI-160AR, FI-160D, FI-160I, FI-200, FI-200AR, FI-200D, FI-200H, FI-200HD, FI-200HI, FI-200I, FI-200W, FI-200WL, FI-200WR		

			
1			
código	505186	referencia	12003428 12038374 Z710804
descripción	filtro rectangular H 73mm L 150mm An 100mm		
Para modelos:	AD-120, AD-120B, AD-120BBTDD-UK, AD-120C, AD-120CW, AD-120HY, AD-90, AD-90BA, AD-90BBT, AD-90BDD, AD-90DD, ADE-120, ADE-120B, ECO-120, ECO-120B, FI-100, FI-100AR, FI-100B, FI-100BBT-UK, FI-120, FI-120AR+DD, FI-120B, FI-120C, FI-120HY-CLINIC, FI-120W, FI-80, FI-80AR, FI-80BBT-UK, FI-80W, FI-E-100, LABP-1000, LABP-1200, LABP-800, MF-120		

componentes mecánicos y accesorios aparatos





1

código	505234	referencia	12016636 12025219 Z400920
descripción	filtro redondo ø 143mm H 125mm		
Para modelos:	AD-15, AD-15D, AD-20C-UK, AD-21, AD-21B, AD-21BDD, AD-21C, AD-21D, AD-21DD, AD-21W, LVC-12, LVC-15, LVC-15D, LVC-21, LVC-21B, LVC-21C, LVC-21D, LVC-21W		



1

código	505098	referencia	12024410 Z200922
descripción	filtro redondo ø 204mm H 140mm		
Para modelos:	AD-45BBT, AD-48, AD-48B, AD-48BDD, AD-48C, AD-48D, AD-48DD, AD-48HY, AD-48W, AD-64, AD-64B, AD-64BBT, AD-64BDD, AD-64BTDD, AD-64C, AD-64CW, AD-64D, AD-64DD, AD-64HY, AD-72, AD-72W, EASY-500, EASY-500B, EASY-500DD, EASY-500HP, FI-30, FI-30AR, FI-30AR+DD, FI-30B, FI-30B-BT-UK, FI-30-UK, FI-48, FI-48AR, FI-48B, FI-48B-BT-UK, FI-48C, FI-48D, FI-48HY-CLINIC, FI-48W, FI-60DD, FI-64, FI-64AR, FI-64B, FI-64B-BT-UK, FI-64C, FI-64D, FI-64HY-CLINIC, FI-64W, FI-72, FI-72AR...(Otros modelos se puede ver en la tienda web)		
accesorios para	505098		
	código	505071	referencia 12024323 12153291 Z200909
tubo de rebose L 180mm ø 40mm			



1

código	505164	referencia	12024284 Z600906
descripción	filtro redondo ø 80mm H 63mm		
Para modelos:	ECO-1200, ECO-2700D, ECO-2700I, ECO-280D, ECO-280I, ECO-370D, ECO-370I, ECO-4000D, ECO-4000I, ECO-460D, ECO-460I, ECO-550D, ECO-550I, ECO-6000D, ECO-6000I, FI-1200, FI-2700D, FI-2700I, FI-280D, FI-280I, FI-370D, FI-370I, FI-4000D, FI-4000I, FI-460D, FI-460I, FI-550D, FI-550I, FI-6000D, FI-6000I, FI-900		



1

código	505078	referencia	12024556 Z200907
descripción	junta altura exterior 23.5mm para cubeta ø ext. 225mm int.ø 200mm		
Para modelos:	AD-45BBT, AD-48, AD-48B, AD-48BDD, AD-48C, AD-48D, AD-48DD, AD-48HY, AD-48W, AD-64, AD-64B, AD-64BBT, AD-64BDD, AD-64BTDD, AD-64C, AD-64CW, AD-64D, AD-64DD, AD-64HY, AD-72, AD-72W, EASY-500, EASY-500B, EASY-500DD, EASY-500HP, FI-30, FI-30AR, FI-30AR+DD, FI-30B, FI-30B-BT-UK, FI-30-UK, FI-48, FI-48AR, FI-48B, FI-48B-BT-UK, FI-48C, FI-48D, FI-48HY-CLINIC, FI-48W, FI-50, FI-60DD, FI-64, FI-64AR, FI-64B, FI-64B-BT-UK, FI-64C, FI-64D, FI-64HY-CLINIC, FI-64W, FI-72...(Otros modelos se puede ver en la tienda web)		



1

código	505077	referencia	12024113 Z400902
descripción	junta altura exterior 23mm para cubeta		
Para modelos:	AD-15, AD-15D, AD-20C-UK, AD-21, AD-21B, AD-21BDD, AD-21C, AD-21D, AD-21DD, AD-21W, CO-350, CO-350-B, CO-350-B-DD, CO-350-COLD, CO-350-COLD-B, CO-350-COLD-B-DD, CO-350-COLD-DD, CO-350-DD, CO-352-COLD, CO-352-COLD-B, CO-352-COLD-B-DD, CO-352-COLD-DD, CO-400, CO-400-B, CO-400-B-DD, CO-400-COLD, CO-400-COLD-B, CO-400-COLD-B-DD, CO-400-COLD-DD, CO-400-DD, CO-400-SOFT, CO-402-COLD, CO-402-COLD-B, CO-402-COLD-B-DD, CO-402-COLD-DD, CO-402W, LVC-12, LVC-15, LVC-15D, LVC-21, LVC-21B, LVC-21C, LVC-21D, LVC-21W, LVR-10, LVR-14, LVR-14D, LVR-20, LVR-20B, LVR-20D...(Otros modelos se puede ver en la tienda web)		

tubos de rebose





1

código	505073	referencia	12010282 Q307041
descripción	junta tórica EPDM espesor 2.62mm int.ø 20.63mm UE 1 pzs		
Para modelos:	AD-15, AD-15D, AD-20C-UK, AD-21, AD-21B, AD-21BDD, AD-21C, AD-21D, AD-21W, CG-1002, CG-1502, CG-2000, CG-2000-2P, CG-2002, CG-2002P, CG9-11, CG9-11AD, CG9-11PLUS, CG9-31PLUS-D, CG9-31PLUS-I, CG9-41, CG9-41AD, CG9-41AD-H, CG9-41H, CG9-41PLUS, CG9-41PLUS-H, CG9-51L, CG9-51LC, CG9-51R, CG9-51RC, CG9-61, CG9-61AD, CG9-61AD-H, CG9-61H, CG9-61OP, CG9-61PLUS, CG9-61PLUS-H, CG9-82, CG9-82AD, CG9-82PLUS, CGF9-121D, CGF9-121D-AD, CGF9-121I, CGF9-121PLUS-D, CGF9-121PLUS-I, FF-35, FI-5420, FI-7630, FTG9-11L, FTG9-11L+R...(Otros modelos se puede ver en la tienda web)		





			
1			
código	532494	referencia	12010165 Q307051 Q307061
descripción	junta tórica EPDM espesor 2.62mm int.ø 36.14mm UE 1 pzs		
Para modelos:	AD-120, AD-120B, AD-120BBTDD-UK, AD-120C, AD-120CW, AD-120HY, AD-45BBT, AD-48, AD-48B, AD-48BDD, AD-48C, AD-48D, AD-48DD, AD-48HY, AD-48W, AD-64, AD-64B, AD-64BBT, AD-64BDD, AD-64BTDD, AD-64C, AD-64CW, AD-64D, AD-64DD, AD-64HY, AD-72, AD-72W, AD-90, AD-90BA, AD-90BBT, AD-90BDD, AD-90DD, ADE-120, ADE-120B, EASY-500, EASY-500B, EASY-500DD, EASY-500HP, ECO-120, ECO-120B, ECO-160, ECO-160D, ECO-160I, ECO-200, ECO-200D, ECO-200H, ECO-200HD, ECO-200HI, ECO-200I, ECO-2700D...(Otros modelos se puede ver en la tienda web)		

			
2			
código	505158	referencia	12040035 Z62104
descripción	tubo de reboso		

			
1			
código	518608	referencia	12023593 Z652101
descripción	tubo de reboso L 150mm ø 42mm		
Para modelos:	ECO-280D, ECO-280I, ECO-370D, ECO-370I, ECO-460D, ECO-460I, ECO-550D, ECO-550I, FI-280D, FI-280I, FI-300R, FI-370D, FI-370I, FI-460D, FI-460I, FI-550D, FI-550I, FI-650R		

			
1			
código	691024	referencia	12019791 R205018
descripción	tubo de reboso L 165mm ø 20mm		
Para modelos:	BME7-05, BME7-10, BME9-05, BME9-10, BMG7-10, BMG9-05, BMG9-10		



			
1			
código	505070	referencia	12025249 Z400907
descripción	tubo de reboso L 165mm ø 25mm		
Para modelos:	AD-15, AD-15D, AD-20C-UK, AD-21, AD-21B, AD-21BDD, AD-21C, AD-21D, AD-21DD, AD-21W, LVC-12, LVC-15, LVC-15D, LVC-21, LVC-21B, LVC-21C, LVC-21D, LVC-21W, LVR-10, LVR-14, LVR-14D, LVR-20, LVR-20B, LVR-20D, MF-21		
accesorios para	505070		
	código	505073	referencia 12010282 Q307041
junta tórica EPDM espesor 2.62mm int.ø 20.63mm UE 1 pzs			

			
1			
código	501337	referencia	12008044 H216111
descripción	tubo de reboso L 172mm ø 16mm		
Para modelos:	BME7-05, BME7-10, BMG7-10		

			
1			
código	505071	referencia	12024323 12153291 Z200909
descripción	tubo de reboso L 180mm ø 40mm		
Para modelos:	AD-45BBT, AD-48, AD-48B, AD-48BDD, AD-48C, AD-48D, AD-48DD, AD-48HY, AD-48W, AD-64, AD-64B, AD-64BBT, AD-64BDD, AD-64C, AD-64CW, AD-64D, AD-64DD, AD-64HY, AD-72, AD-72W, EASY-500, EASY-500DD, EASY-500HP, FI-30, FI-30AR, FI-30AR+DD, FI-30B, FI-30B-BT-UK, FI-30-UK, FI-48, FI-48AR, FI-48B, FI-48B-BT-UK, FI-48C, FI-48D, FI-48HY-CLINIC, FI-48W, FI-50, FI-60DD, FI-64, FI-64AR, FI-64B, FI-64B-BT-UK, FI-64C, FI-64D, FI-64HY-CLINIC, FI-64W, FI-72, FI-72AR, FI-72W... (Otros modelos se puede ver en la tienda web)		
accesorios para	505071		
	código	505098	referencia 12024410 Z200922
filtro redondo ø 204mm H 140mm			
	código	517004	referencia —
junta tórica EPDM espesor 2.62mm int.ø 34.6mm UE 1 pzs			

			
1			
código	512022	referencia	12016680 Z682101
descripción	tubo de reboso L 195mm ø 42mm plástico lavavajillas		
Para modelos:	ECO-1200, FI-1200, FI-900		

componentes mecánicos y accesorios aparatos

			
1			
código	505072	referencia	12023658 Z710901
descripción	tubo de rebose L 395mm ø 42mm		
Para modelos:	AD-120, AD-120B, AD-120BBTDD-UK, AD-120C, AD-120CW, AD-120HY, AD-90, AD-90BA, AD-90BBT, AD-90BDD, AD-90DD, ADE-120, ADE-120B, ECO-120, ECO-120B, FI-100, FI-100AR, FI-100B, FI-100BBT-UK, FI-120, FI-120AR+DD, FI-120B, FI-120C, FI-120HY-CLINIC, FI-120W, FI-80, FI-80AR, FI-80BBT-UK, FI-80W, FI-E-100, LABP-1000, LABP-1200, LABP-800, MF-120		
accesorios para	505072		
			
código	532494	referencia	12010165 Q307051 Q307061
descripción	junta tórica EPDM espesor 2.62mm int.ø 36.14mm UE 1 pzs		

			
1			
código	518607	referencia	12024449 Z270901
descripción	tubo de rebose L 480mm ø 44mm		
Para modelos:	ECO-160, ECO-160D, ECO-160I, ECO-200, ECO-200D, ECO-200H, ECO-200HD, ECO-200HI, ECO-200I, FI-160, FI-160AR, FI-160D, FI-160I, FI-200, FI-200AR, FI-200D, FI-200H, FI-200HD, FI-200HI, FI-200I, FI-200W, FI-200WL, FI-200WR		

árboles de accionamiento			
			
1			
código	692327	referencia	12024595 Z275011
descripción	árbol D1 ø 16.5mm sistemas de lavado ø 20mm L 165mm D2 ø 20mm FAGOR		
Para modelos:	ECO-160, ECO-160D, ECO-160I, ECO-200, ECO-200D, ECO-200H, ECO-200HD, ECO-200HI, ECO-200I, FI-160, FI-160AR, FI-160D, FI-160I, FI-200, FI-200AR, FI-200D, FI-200H, FI-200HD, FI-200HI, FI-200I, FI-200W, FI-200WL, FI-200WR		





contenedores			
tapas de recipientes			
			
1			
código	510001	referencia	12018055 Z211108
descripción	tapa ø 66mm apto para recipiente abrillantador		

recipientes de dosificación			
			
1			
código	505263	referencia	12021190
descripción	recipiente de dosificación L 90mm An 80mm H 105mm		

recipientes de sal			
			
1			
código	505229	referencia	12023847 Z471105
descripción	filtro L 71mm ø 10mm recipiente de sal cónico		
Para modelos:	AD-15D, AD-21D, AD-48D, AD-64D, FI-48, FI-48AR, FI-48B, FI-48B-BT-UK, FI-48C, FI-48D, FI-48HY-CLINIC, FI-48W, FI-64, FI-64AR, FI-64B, FI-64B-BT-UK, FI-64C, FI-64D, FI-64HY-CLINIC, FI-64W, LVC-15D, LVC-21D		



			
1			
código	505220	referencia	12025267 12047154 Z471107
descripción	junta plana para contenedor de sal goma espesor 3.9mm int.ø 68mm ø ext. 86mm		
Para modelos:	AD-15D, AD-21D, AD-48D, AD-64D, CO-400-SOFT, FI-48, FI-48AR, FI-48B, FI-48B-BT-UK, FI-48C, FI-48D, FI-48HY-CLINIC, FI-48W, FI-64, FI-64AR, FI-64B, FI-64B-BT-UK, FI-64C, FI-64D, FI-64HY-CLINIC, FI-64W, LVC-15D, LVC-21D		

			
2			
código	505101	referencia	12025142 Z471102
descripción	recipiente de sal ø 90mm H 86mm		
Para modelos:	AD-15D, AD-21D, AD-48D, AD-64D, FI-48, FI-48AR, FI-48B, FI-48B-BT-UK, FI-48C, FI-48D, FI-48HY-CLINIC, FI-48W, FI-64, FI-64AR, FI-64B, FI-64B-BT-UK, FI-64C, FI-64D, FI-64HY-CLINIC, FI-64W, LVC-15D, LVC-21D, LVR-14D, LVR-20D		
accesorios para	505101		
	código	referencia	12025267 12047154 Z471107
	505220		
	junta plana para contenedor de sal goma espesor 3.9mm int.ø 68mm ø ext. 86mm		
	código	referencia	12024031 Z471109
	506015		
	junta tórica EPDM espesor 3.53mm int.ø 39.69mm UE 1 pzs		
	código	referencia	12025272 Z471106
	517401		
	tuerca ø 92mm H 10.5mm para contenedor de sal int.ø 64.5mm		
	código	referencia	12025273 Z471108
	524177		
	tapa ø 69mm H 20mm para contenedor de sal int.ø 50mm		

			
1			
código	524177	referencia	12025273 Z471108
descripción	tapa ø 69mm H 20mm para contenedor de sal int.ø 50mm		
Para modelos:	AD-15D, AD-21D, AD-48D, AD-64D, CO-400-SOFT, FI-48, FI-48AR, FI-48B, FI-48B-BT-UK, FI-48C, FI-48D, FI-48HY-CLINIC, FI-48W, FI-64, FI-64AR, FI-64B, FI-64B-BT-UK, FI-64C, FI-64D, FI-64HY-CLINIC, FI-64W, LVC-15D, LVC-21D		
accesorios para	524177		
	código	referencia	—
	524148		
	junta tórica EPDM espesor 3.53mm int.ø 40.86mm UE 1 pzs		

			
1			
código	517401	referencia	12025272 Z471106
descripción	tuerca ø 92mm H 10.5mm para contenedor de sal int.ø 64.5mm		
Para modelos:	AD-15D, AD-21D, AD-48D, AD-64D, CO-400-SOFT, FI-48, FI-48AR, FI-48B, FI-48B-BT-UK, FI-48C, FI-48D, FI-48HY-CLINIC, FI-48W, FI-64, FI-64AR, FI-64B, FI-64B-BT-UK, FI-64C, FI-64D, FI-64HY-CLINIC, FI-64W, LVC-15D, LVC-21D		

calentadores de agua

calentadores de agua para lavavajillas

			
1			
código	505209	referencia	1200002017 12022893 12038284 Z401701 Z401730
descripción	calentador de agua ø 130mm L 310mm		
Para modelos:	AD-15, AD-15D, AD-20C-UK, AD-21, AD-21B, AD-21BDD, AD-21C, AD-21D, AD-21DD, AD-21W, LVC-12, LVC-15, LVC-15D, LVC-21, LVC-21B, LVC-21C, LVC-21D, LVC-21W, LVR-10, LVR-14, LVR-14D, LVR-20, LVR-20B, LVR-20D, MF-21		

componentes mecánicos y accesorios aparatos



1

código	505210	referencia	1200005017 12022943 12038293 Z201701 Z201710
descripción	calentador de agua ø 150mm L 460mm entrada ø 10		
Para modelos:	AD-120, AD-120B, AD-120C, AD-120CW, AD-48, AD-48B, AD-48BDD, AD-48C, AD-48D, AD-48DD, AD-48W, AD-64, AD-64B, AD-64BDD, AD-64C, AD-64CW, AD-64D, AD-64DD, AD-72, AD-72W, AD-90, AD-90BA, AD-90BDD, AD-90DD, EASY-500, EASY-500B, EASY-500DD, EASY-500HP, FI-100, FI-100AR, FI-100B, FI-120, FI-120AR+DD, FI-120B, FI-120C, FI-120W, FI-30, FI-30AR, FI-30AR+DD, FI-30B, FI-30-UK, FI-48, FI-48AR, FI-48B, FI-48C, FI-48D, FI-48W, FI-50, FI-60DD, FI-64...(Otros modelos se puede ver en la tienda web)		



1

código	505296	referencia	12038196 WX0116204
descripción	calentador de agua ø 180mm L 410mm		

juntas



1

código	699343	referencia	12048366
descripción	junta L 118mm An 73mm H 9mm espesor 9mm		
Para modelos:	AD-125, AD-125HRS, AD-125-SOFT, CO-110, CO-110B, CO-110BDD, CO-110DD, CO-112, CO-112B, CO-112BDD, CO-112DD, CO-170, CO-170B, CO-170BDD, CO-170DD, CO-170HRS, CO-170HRSDD, CO-170HRS-SOFT, CO-170-SOFT, CO-172, CO-172B, CO-172BDD, CO-172DD, COP-173, COP-173B, COP-173BDD, COP-173DD, COP-173HRS, COP-173HRSDD, COP-173-SOFT, COP-174, COP-174B, COP-174BDD, COP-174DD, COP-174HRS, COP-174HRSDD		

platos giratorios

platos giratorios



1

código	505144	referencia	12019337 12020267 Z645901 Z645920
descripción	plato giratorio		



1

código	505170	referencia	12019954 Z405901
descripción	plato giratorio ø 290mm plástico soporte ø 22mm altura total 54mm		
Para modelos:	LVR-10, LVR-14, LVR-14D, LVR-20, LVR-20B, LVR-20D		

aros giratorios



1

código	505165	referencia	12019578 12039828 Z605911
descripción	cojinete plato giratorio		



			
1			
código	505154	referencia	12019027 Z645909
descripción	cojinete plato giratorio completo		

cartuchos descalcificadores

columnas descalcificadoras

			
1			
código	505102	referencia	12024874 Z471101
descripción	descalcificador cuádruple L 380mm An 180mm		
Para modelos:	AD-15D, AD-21D, AD-48D, AD-64D, CO-400-SOFT, FI-48, FI-48AR, FI-48B, FI-48B-BT-UK, FI-48C, FI-48D, FI-48HY-CLINIC, FI-48W, FI-64, FI-64AR, FI-64B, FI-64B-BT-UK, FI-64C, FI-64D, FI-64HY-CLINIC, FI-64W, LVC-15D, LVC-21D, LVR-14D, LVR-20D		

			
1			
código	530000	referencia	270064
descripción	descalcificador cuádruple L 380mm An 180mm		

recambios y accesorios

			
1			
código	691865	referencia	12018145 Z643013
descripción	accionador para puerta para interruptor L 102mm ø ext. 11.4		
Para modelos:	FI-300B, FI-300R, FI-650R		

			
1			
código	530905	referencia	12024487 Z105055000
descripción	casquillo distanciador para accionamiento L 24.5mm int.ø 17.5mm ø ext. 20mm para FAGOR		
Para modelos:	ECO-160D, ECO-160I, ECO-200D, ECO-200HD, ECO-200HI, ECO-200I, FI-160AR, FI-160D, FI-160I, FI-200AR, FI-200D, FI-200HD, FI-200HI, FI-200I, FI-200WL, FI-200WR		

cajas y paneles frontales

escuadra de sujeción

			
1			
código	505239	referencia	12021876 Z276354
descripción	escuadra de sujeción L 80mm An 80mm H 38mm		
Para modelos:	ECO-120, ECO-120B, ECO-160, ECO-160D, ECO-160I, ECO-200, ECO-200D, ECO-200H, ECO-200HD, ECO-200HI, ECO-200I, ECO-280D, ECO-280I, ECO-370D, ECO-370I, ECO-460D, ECO-460I, ECO-550D, ECO-550I, FI-100, FI-100AR, FI-100B, FI-120, FI-120B, FI-120W, FI-160, FI-160AR, FI-160D, FI-160I, FI-200, FI-200AR, FI-200D, FI-200H, FI-200HD, FI-200HI, FI-200I, FI-200W, FI-200WL, FI-200WR, FI-280D, FI-280I, FI-370D, FI-370I, FI-460D, FI-460I, FI-550D, FI-550I, FI-80, FI-80W, MF-120		

			
1			
código	505325	referencia	12023093 Z850111
descripción	pletina sujeción para termostato acero inoxidable L 48mm An 35mm espesor 1.2mm H 17mm		
Para modelos:	ECO-160, ECO-160D, ECO-160I, ECO-200, ECO-200D, ECO-200H, ECO-200HD, ECO-200HI, ECO-200I, ECO-2300, ECO-2700D, ECO-2700I, ECO-280D, ECO-280I, ECO-3000, ECO-370D, ECO-370I, ECO-4000D, ECO-4000I, ECO-460D, ECO-460I, ECO-550D, ECO-550I, ECO-6000D, ECO-6000I, FI-160, FI-160D, FI-160AR, FI-160D, FI-160I, FI-200, FI-200AR, FI-200D, FI-200H, FI-200HD, FI-200HI, FI-200I, FI-200W, FI-200WL, FI-200WR, FI-2300, FI-2700D, FI-2700I, FI-280D, FI-280I, FI-3000, FI-370D, FI-370I, FI-4000D...(Otros modelos se puede ver en la tienda web)		

			
1			
código	650103	referencia	12015774 Z400106
descripción	travesaño L 380mm An 50mm H 10mm distancia de sujeción 355mm		
Para modelos:	LVC-12, LVC-15, LVC-15D, LVR-10, LVR-14, LVR-14D		

paneles



código	505337	referencia	12025012 Z208918
descripción	membrana de teclado para lavavajillas FI-48C L 583mm An 62mm		
Para modelos:	FI-48AR, FI-48C		

puertas abatibles



código	505241	referencia	12014320 Z212902
descripción	puerta para depósito detergente An 120mm H 110mm espesor 8mm		
Para modelos:	FI-30, FI-48, FI-48B, FI-50, FI-64, FI-64B, FI-72		



código	505235	referencia	1200002020 12038297
descripción	puerta abatible para lavavajillas An 460mm H 340mm espesor 25mm		
Para modelos:	AD-21W, LVC-21, LVC-21B, LVC-21C, LVC-21D, LVC-21W		

mecanismos de capota para lavavajillas

pernos



código	505219	referencia	12023966 Z710542
descripción	eje para rueda de rodadura		
Para modelos:	AD-120, AD-120B, AD-120BBTDD-UK, AD-120C, AD-120CW, AD-120HY, AD-90, AD-90BA, AD-90BBT, AD-90BDD, AD-90DD, ADE-120, ADE-120B, ECO-120, ECO-120B, FI-100, FI-100AR, FI-100B, FI-100BBT-UK, FI-120, FI-120AR+DD, FI-120B, FI-120C, FI-120HY-CLINIC, FI-120W, FI-80, FI-80AR, FI-80BBT-UK, FI-80W, FI-E-100, LABP-1000, LABP-1200, LABP-800, MF-120		

casquillos



código	505272	referencia	12025255 Z710515
descripción	casquillo ø ext. 22mm int.ø 10mm L 7mm plástico		
Para modelos:	AD-120, AD-120B, AD-120BBTDD-UK, AD-120C, AD-120CW, AD-120HY, AD-125, AD-125HRS, AD-125-SOFT, AD-90, AD-90BA, AD-90BBT, AD-90BDD, AD-90DD, ADE-120, ADE-120B, CO-110, CO-110B, CO-110BDD, CO-110DD, CO-112, CO-112B, CO-112BDD, CO-112DD, CO-142W, CO-142WDD, CO-170, CO-170B, CO-170BDD, CO-170DD, CO-170HRS, CO-170HRSDD, CO-170HRS-SOFT, CO-170-SOFT, CO-172, CO-172B, CO-172BDD, CO-172DD, COP-173, COP-173B, COP-173BDD, COP-173DD, COP-173HRS, COP-173HRSDD, COP-173-SOFT, COP-174, COP-174B, COP-174BDD, COP-174DD, COP-174HRS...(Otros modelos se puede ver en la tienda web)		

soporte de muelle



código	505261	referencia	12023671 Z270512
descripción	soporte de muelle mecanismo de campana D1 ø 46mm D2 ø 36mm An 27mm		
Para modelos:	ECO-160, ECO-160D, ECO-160I, ECO-200, ECO-200D, ECO-200H, ECO-200HD, ECO-200HI, ECO-200I, ECO-2700D, ECO-2700I, ECO-280D, ECO-280I, ECO-370D, ECO-370I, ECO-4000D, ECO-4000I, ECO-460D, ECO-460I, ECO-550D, ECO-550I, ECO-6000D, ECO-6000I, FI-160, FI-160AR, FI-160D, FI-160I, FI-200, FI-200AR, FI-200D, FI-200H, FI-200HD, FI-200HI, FI-200I, FI-200W, FI-200WL, FI-200WR, FI-2700D, FI-2700I, FI-280D, FI-280I, FI-370D, FI-370I, FI-4000D, FI-4000I, FI-460D, FI-460I, FI-550D, FI-550I, FI-6000D...(Otros modelos se puede ver en la tienda web)		



varillaje			
código	501482	referencia	12019124 Z680522
descripción	barra de tracción L 500mm para mecanismos de capota para lavavajillas		
Para modelos:	ECO-1200, FI-1200, FI-900		

anillos de fricción			
código	505226	referencia	12018644 Q308009
descripción	anillo deslizante PTFE ø ext. 19mm int.ø 7.5mm espesor 2mm UE 1 pzs		
Para modelos:	FI-300B, FI-300R, FI-650R		

código	505225	referencia	12009922 Q308012
descripción	anillo deslizante PTFE ø ext. 30mm int.ø 10mm espesor 3mm para bisagra de campana UE 1 pzs		
Para modelos:	AD-120, AD-120B, AD-120BBTDD-UK, AD-120C, AD-120CW, AD-120HY, AD-90, AD-90BA, AD-90BBT, AD-90BDD, AD-90DD, ADE-120, ADE-120B, ECO-120, ECO-120B, FI-100, FI-100AR, FI-100B, FI-100BBT-UK, FI-120, FI-120AR+DD, FI-120B, FI-120C, FI-120HY-CLINIC, FI-120W, FI-80, FI-80AR, FI-80BBT-UK, FI-80W, FI-E-100, LABP-1000, LABP-1200, LABP-800, MF-120		

ruedas de rodadura			
código	505218	referencia	12025210 Z710546
descripción	rollo ø 37mm H 12mm plástico agujero ø 12.1mm		
Para modelos:	AD-120, AD-120B, AD-120BBTDD-UK, AD-120C, AD-120CW, AD-120HY, AD-90, AD-90BA, AD-90BBT, AD-90BDD, AD-90DD, ADE-120, ADE-120B, ECO-120, ECO-120B, FI-100, FI-100AR, FI-100B, FI-100BBT-UK, FI-120, FI-120AR+DD, FI-120B, FI-120C, FI-120HY-CLINIC, FI-120W, FI-80, FI-80AR, FI-80BBT-UK, FI-80W, FI-E-100, LABP-1000, LABP-1200, LABP-800, MF-120		

otros			
código	529240	referencia	12010068 Q308000
descripción	arandela ø ext. 16.5mm int.ø 8.2mm plástico espesor 4mm		
Para modelos:	AD-120, AD-120B, AD-120BBTDD-UK, AD-120C, AD-120CW, AD-120HY, AD-90, AD-90BA, AD-90BBT, AD-90BDD, AD-90DD, ADE-120, ADE-120B, ECO-120, ECO-1200, ECO-120B, ECO-160, ECO-1600, ECO-160D, ECO-160I, ECO-200, ECO-200D, ECO-200H, ECO-200HD, ECO-200HI, ECO-200I, ECO-2300, ECO-280D, ECO-280I, ECO-3000, ECO-370D, ECO-370I, ECO-460D, ECO-460I, ECO-550D, ECO-550I, FI-100, FI-100AR, FI-100B, FI-100BBT-UK, FI-120, FI-1200, FI-120AR+DD, FI-120B, FI-120C, FI-120HY-CLINIC, FI-120W, FI-160, FI-1600, FI-160D... (Otros modelos se puede ver en la tienda web)		

código	529241	referencia	12010132 Q308002
descripción	arandela para lavavajillas ø ext. 13mm int.ø 6mm plástico espesor 3.5mm		
Para modelos:	AD-120, AD-120B, AD-120BBTDD-UK, AD-120C, AD-120CW, AD-120HY, AD-90, AD-90BA, AD-90BBT, AD-90BDD, AD-90DD, ADE-120, ADE-120B, CE-15, CE-9, EASY-500, EASY-500B, EASY-500DD, EASY-500HP, EASY-500HPWBDD, ECO-120, ECO-120B, ECO-160, ECO-1600, ECO-160D, ECO-160I, ECO-200, ECO-200D, ECO-200H, ECO-200HD, ECO-200HI, ECO-200I, ECO-2300, ECO-2700D, ECO-2700I, ECO-280D, ECO-280I, ECO-3000, ECO-370D, ECO-370I, ECO-4000D, ECO-4000I, ECO-460D, ECO-460I, ECO-550D, ECO-550I, ECO-6000D, ECO-6000I, FI-100, FI-100AR... (Otros modelos se puede ver en la tienda web)		

código	517431	referencia	12011392 Z270515
descripción	soporte para resorte enrollado ømm L 105mm An 44mm H 20mm		
Para modelos:	ECO-160, ECO-160D, ECO-160I, ECO-200, ECO-200D, ECO-200H, ECO-200HD, ECO-200HI, ECO-200I, FI-160, FI-160AR, FI-160D, FI-160I, FI-200, FI-200AR, FI-200D, FI-200H, FI-200HD, FI-200HI, FI-200I, FI-200W, FI-200WL, FI-200WR		

código	691890	referencia	12023973 Z270516
descripción	tope de goma D1 ø 13mm D2 ø 7mm H 10mm		
Para modelos:	ECO-160, ECO-160D, ECO-160I, ECO-200, ECO-200D, ECO-200H, ECO-200HD, ECO-200HI, ECO-200I, ECO-280D, ECO-280I, ECO-370D, ECO-370I, ECO-460D, ECO-460I, ECO-550D, ECO-550I, FI-160, FI-160AR, FI-160D, FI-160I, FI-200, FI-200AR, FI-200D, FI-200H, FI-200HD, FI-200HI, FI-200I, FI-200W, FI-200WL, FI-200WR, FI-280D, FI-280I, FI-370D, FI-370I, FI-460D, FI-460I, FI-550D, FI-550I		



guías para cestos

barras guía



1

código	505329	referencia	12038483 12Z3150290
descripción	guía de cesto L 593mm H 75mm		
Para modelos:	ECO-280D, ECO-280I, ECO-370D, ECO-370I, ECO-460D, ECO-460I, ECO-550D, ECO-550I, FI-280D, FI-280I, FI-370D, FI-370I, FI-460D, FI-460I, FI-550D, FI-550I		

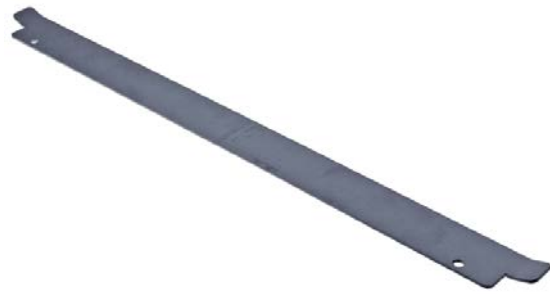

1

código	971056	referencia	12014772 12021776 Z710317 Z710326
descripción	guía de cesto pos. de montaje arriba L 490mm H 36mm agujero ø 6mm dist. del agujero 400mm		
Para modelos:	AD-120, AD-120B, AD-120BBTDD-UK, AD-120C, AD-120CW, AD-120HY, AD-90, AD-90BA, AD-90BBT, AD-90BDD, AD-90DD, ADE-120, ADE-120B, ECO-120, ECO-120B, FI-100, FI-100AR, FI-100B, FI-100BBT-UK, FI-120, FI-120AR+DD, FI-120B, FI-120C, FI-120HY-CLINIC, FI-120W, FI-80, FI-80AR, FI-80BBT-UK, FI-80W, FI-E-100, LABP-1000, LABP-1200, LABP-800, MF-120		



1

código	505328	referencia	12038478 12Z3350050
descripción	guía de cesto pos. de montaje derecho abajo L 590mm H 70mm		
Para modelos:	ECO-370D, ECO-550D, FI-370D, FI-550D		



1

código	505327	referencia	12041428 12Z3350250
descripción	guía de cesto pos. de montaje izquierdo abajo L 590mm H 70mm		
Para modelos:	ECO-370I, ECO-550I, FI-370I, FI-550I		

soportes para cestos



1

código	504248	referencia	12023365 Z312509
descripción	soporte para cestos L 435m An 420mm H 90mm 90°		

otros



1

código	970861	referencia	12024644 Z105027
descripción	casquillo para carro para cestas pos. de montaje plato giratorio ø ext. 40 int. ø 33.5mm H 31.5mm latón		
Para modelos:	ECO-160, ECO-1600, ECO-160D, ECO-160I, ECO-200, ECO-200D, ECO-200H, ECO-200HD, ECO-200HI, ECO-200I, ECO-2300, ECO-280D, ECO-280I, ECO-3000, ECO-370D, ECO-370I, ECO-460D, ECO-460I, ECO-550D, ECO-550I, FI-160, FI-1600, FI-160AR, FI-160D, FI-160I, FI-200, FI-200AR, FI-200D, FI-200H, FI-200HD, FI-200HI, FI-200I, FI-200W, FI-200WL, FI-200WR, FI-2300, FI-280D, FI-280I, FI-3000, FI-370D, FI-370I, FI-460D, FI-460I, FI-550D, FI-550I		





componentes mecánicos y accesorios aparatos





			
1			
código	524591	referencia	12024307 Z275041 Z275075
descripción	pieza deslizante para barra guía L 50mm An 27mm H 16mm		
Para modelos:	ECO-160, ECO-160D, ECO-160I, ECO-200, ECO-200D, ECO-200H, ECO-200HD, ECO-200HI, ECO-200I, ECO-280D, ECO-280I, ECO-370D, ECO-370I, ECO-460D, ECO-460I, ECO-550D, ECO-550I, FI-160, FI-160AR, FI-160D, FI-160I, FI-200, FI-200AR, FI-200D, FI-200H, FI-200HD, FI-200HI, FI-200I, FI-200W, FI-200WL, FI-200WR, FI-280D, FI-280I, FI-370D, FI-370I, FI-460D, FI-460I, FI-550D, FI-550I		

cámaras de aire

cámaras de aire

			
1			
código	505094	referencia	12024350 Z203011
descripción	cámara de aire		
Para modelos:	AD-120, AD-120B, AD-120BBTDD-UK, AD-120C, AD-120CW, AD-120HY, AD-15, AD-15D, AD-20C-UK, AD-21, AD-21B, AD-21BDD, AD-21C, AD-21D, AD-21DD, AD-21W, AD-45BBT, AD-48, AD-48B, AD-48BDD, AD-48C, AD-48D, AD-48DD, AD-48HY, AD-48W, AD-64, AD-64B, AD-64BBT, AD-64BDD, AD-64BTDD, AD-64C, AD-64CW, AD-64D, AD-64DD, AD-64HY, AD-72, AD-72W, AD-90, AD-90BA, AD-90BBT, AD-90BDD, AD-90DD, ADE-120, ADE-120B, EASY-500, EASY-500B, EASY-500DD, EASY-500HP, EASY-500HPWBDD, ECO-120...(Otros modelos se puede ver en la tienda web)		
accesorios para	505094		
	código	505096	referencia
			12024157 Z201312 Z203012
	codo		
	código	505184	referencia
			12024222 Z203013
	armella		
	código	529412	referencia
			12009873 Q307003
	junta tórica EPDM espesor 2.62mm int.ø 10.78mm UE 1 pzs		

			
1			
código	510103	referencia	12090549 12134442
descripción	cámara de aire L 85mm An 20mm H 80mm tubo ø 6mm plástico		
Para modelos:	CO-350, CO-350-B, CO-350-B-DD, CO-350-COLD, CO-350-COLD-B, CO-350-COLD-B-DD, CO-350-COLD-DD, CO-350-DD, CO-352-COLD, CO-352-COLD-B, CO-352-COLD-B-DD, CO-352-COLD-DD, CO-400, CO-400-B, CO-400-B-DD, CO-400-COLD, CO-400-COLD-B, CO-400-COLD-B-DD, CO-400-COLD-DD, CO-400-DD, CO-400-SOFT, CO-402-COLD, CO-402-COLD-B, CO-402-COLD-B-DD, CO-402-COLD-DD, CO-402W		
repuestos para	510103		
	código	505045	referencia
			12009912 Q307036
	junta tórica EPDM espesor 1.78mm int.ø 5.28mm UE 1 pzs		

repuestos para	510103		
	código	505094	referencia
			12024350 Z203011
	cámara de aire		
	código	510016	referencia
			—
	armella para empalme de recipiente abrillantador		
	código	510105	referencia
			—
	empalme de tubo para cámara de aire		

mecánicas para lavavajillas de cinta transportadora

			
1			
código	505240	referencia	12018670 Z331202
descripción	accionador		
Para modelos:	ECO-370D, ECO-550D, FI-370D, FI-550D		

			
1			
código	519525	referencia	12023176 Z275021
descripción	brida para árbol de accionamiento ø 44mm int.ø 35mm ø ext. 119mm para FAGOR		
Para modelos:	ECO-160, ECO-160D, ECO-160I, ECO-200, ECO-200D, ECO-200H, ECO-200HD, ECO-200HI, ECO-200I, FI-160, FI-160AR, FI-160D, FI-160I, FI-200, FI-200AR, FI-200D, FI-200H, FI-200HD, FI-200HI, FI-200I, FI-200W, FI-200WL, FI-200WR		

			
1			
código	530905	referencia	12024487 Z105055000
descripción	casquillo distanciador para accionamiento L 24.5mm int.ø 17.5mm ø ext. 20mm para FAGOR		
Para modelos:	ECO-160D, ECO-160I, ECO-200D, ECO-200HD, ECO-200HI, ECO-200I, FI-160AR, FI-160D, FI-160I, FI-200AR, FI-200D, FI-200HD, FI-200HI, FI-200I, FI-200WL, FI-200WR		

componentes mecánicos y accesorios aparatos

1 

código	517826	referencia	12024682 Z270336 Z270336000
descripción	guía de puerta L 620mm An 37mm H 13mm pos. de montaje derecho		
Para modelos:	ECO-160, ECO-160D, ECO-160I, ECO-200, ECO-200D, ECO-200H, ECO-200HD, ECO-200HI, ECO-200I, ECO-280D, ECO-280I, ECO-370D, ECO-370I, ECO-460D, ECO-460I, ECO-550D, ECO-550I, FI-160, FI-160AR, FI-160D, FI-160I, FI-200, FI-200AR, FI-200D, FI-200H, FI-200HD, FI-200HI, FI-200I, FI-200W, FI-200WL, FI-200WR, FI-280D, FI-280I, FI-370D, FI-370I, FI-460D, FI-460I, FI-550D, FI-550I		

2 

código	505333	referencia	1200000140 12038281 Z335011
descripción	marco de soporte L 595mm An 480mm H 40mm		
Para modelos:	ECO-370D, ECO-370I, ECO-550D, ECO-550I, FI-370D, FI-370I, FI-550D, FI-550I		

1 

código	504451	referencia	12009828 12021015 Q362000 Z105026
descripción	pasador elástico ø 6.3mm L 50mm Inox		
Para modelos:	ECO-160, ECO-160D, ECO-160I, ECO-200, ECO-200D, ECO-200H, ECO-200HD, ECO-200HI, ECO-200I, ECO-2300, ECO-280D, ECO-280I, ECO-3000, ECO-370D, ECO-370I, ECO-460D, ECO-460I, ECO-550D, ECO-550I, FI-160, FI-160D, FI-160AR, FI-160I, FI-200, FI-200AR, FI-200D, FI-200H, FI-200HD, FI-200HI, FI-200I, FI-200W, FI-200WL, FI-200WR, FI-2300, FI-280D, FI-280I, FI-3000, FI-370D, FI-370I, FI-460D, FI-460I, FI-550D, FI-550I		

1 

código	504387	referencia	12024391 Z271204
descripción	resorte derecho para sistema de transporte alojamiento del ejem ø 10.5mm L 36mm Anmm Hmm espesor de hilo 1.4mm		
Para modelos:	ECO-160, ECO-160D, ECO-160I, ECO-200, ECO-200D, ECO-200H, ECO-200HD, ECO-200HI, ECO-200I, ECO-280D, ECO-280I, ECO-370D, ECO-370I, ECO-460D, ECO-460I, ECO-550D, ECO-550I, FI-160, FI-160AR, FI-160D, FI-160I, FI-200, FI-200AR, FI-200D, FI-200H, FI-200HD, FI-200HI, FI-200I, FI-200W, FI-200WL, FI-200WR, FI-280D, FI-280I, FI-370D, FI-370I, FI-460D, FI-460I, FI-550D, FI-550I		

1 

código	505332	referencia	12033009 6020000447
descripción	rollo corto L 100mm ø 40mm		

1 

código	505330	referencia	12031651 12048195 INXC401001
descripción	rollo L 500mm ø 40mm plástico eje ø 10mm eje L 15mm		

1 

código	505331	referencia	12032894 6020000446
descripción	rollo L 505mm ø 40mm rosca M8		

1 

código	697775	referencia	12024102 Z275007
descripción	rueda dentada DIN/ISO 08 B-1x26T división 1/2" dientes 26 soporte de eje ø 20mm H 28mm ø cubo 43mm		
Para modelos:	ECO-160, ECO-160D, ECO-160I, ECO-200HD, ECO-200HI, ECO-280D, ECO-280I, FI-160, FI-160AR, FI-160D, FI-160I, FI-200HD, FI-200HI, FI-200WL, FI-200WR, FI-280D, FI-280I		



1 

código	505338	referencia	12002678 1222712130
descripción	soporte L 70mm An 70mm H 30mm rosca M5		
Para modelos:	ECO-160, ECO-160D, ECO-160I, ECO-200, ECO-200D, ECO-200H, ECO-200HD, ECO-200HI, ECO-200I, ECO-280D, ECO-280I, ECO-370D, ECO-370I, ECO-460D, ECO-460I, ECO-550D, ECO-550I, FI-160, FI-160AR, FI-160D, FI-160I, FI-200, FI-200AR, FI-200D, FI-200H, FI-200HD, FI-200HI, FI-200I, FI-200W, FI-200WL, FI-200WR, FI-280D, FI-280I, FI-370D, FI-370I, FI-460D, FI-460I, FI-550D, FI-550I		



			
1			
código	505321	referencia	12022145 Z271206
descripción	soporte de imán para sistema de transporte ø 35mm agujero ø 6mm dist. del agujero 21mm espesor 2mm		
Para modelos:	ECO-160, ECO-160D, ECO-160I, ECO-200, ECO-200D, ECO-200H, ECO-200HD, ECO-200HI, ECO-200I, ECO-280D, ECO-280I, ECO-370D, ECO-370I, ECO-460D, ECO-460I, ECO-550D, ECO-550I, FI-160, FI-160AR, FI-160D, FI-160I, FI-200, FI-200AR, FI-200D, FI-200H, FI-200HD, FI-200HI, FI-200I, FI-200W, FI-200WL, FI-200WR, FI-280D, FI-280I, FI-370D, FI-370I, FI-460D, FI-460I, FI-550D, FI-550I		

			
1			
código	516101	referencia	12024568 Z231106
descripción	bloqueo antirretorno lavavajillas tubo ø 12mm		
Para modelos:	AD-120, AD-120B, AD-120C, AD-20C-UK, AD-21, AD-21B, AD-21BDD, AD-21C, AD-21DD, AD-21W, AD-48, AD-48B, AD-48BDD, AD-48C, AD-48DD, AD-48W, AD-64, AD-64B, AD-64BDD, AD-64C, AD-64CW, AD-64D, AD-64DD, AD-72, AD-72W, AD-90, AD-90BA, AD-90BDD, AD-90DD, CO-110, CO-110B, CO-110BDD, CO-110DD, CO-112, CO-112B, CO-112BDD, CO-112DD, CO-170, CO-170B, CO-170BDD, CO-170DD, CO-170HRS, CO-170HRSDD, CO-170HRS-SOFT, CO-170-SOFT, CO-172, CO-172B, CO-172BDD, CO-172DD, CO-350...(Otros modelos se puede ver en la tienda web)		
repuestos para	516101		
	código	506367	referencia
			—
	 junta plana goma ø ext. 40mm int.ø 28mm espesor 1.8mm UE 1 pzs		

			
2			
código	504450	referencia	12024681 Z275022 Z275025
descripción	tirante para sistema de transporte L 98mm int.ø 45mm ø ext. 50/34mm		
Para modelos:	ECO-160, ECO-160D, ECO-160I, ECO-200, ECO-200D, ECO-200H, ECO-200HD, ECO-200HI, ECO-200I, ECO-280D, ECO-280I, ECO-370D, ECO-370I, ECO-460D, ECO-460I, ECO-550D, ECO-550I, FI-160, FI-160AR, FI-160D, FI-160I, FI-200, FI-200AR, FI-200D, FI-200H, FI-200HD, FI-200HI, FI-200I, FI-200W, FI-200WL, FI-200WR, FI-280D, FI-280I, FI-370D, FI-370I, FI-460D, FI-460I, FI-550D, FI-550I		
accesorios para	504450		
	código	504451	referencia
			12009828 12021015 Q362000 Z105026
	 pasador elástico ø 6.3mm L 50mm Inox		

otros			
			
1			
código	506160	referencia	Q231450000
descripción	arandela int.ø 8.6mm ø ext. 16mm espesor 1.5mm inox UE 1 pzs		

			
1			
código	505151	referencia	Z850603
descripción	pasador plástico		

bloqueos antirretorno

bloqueos antirretorno

			
1			
código	505183	referencia	12023857 1210305189 Z718418
descripción	bloqueo antirretorno lavavajillas		
Para modelos:	AD-120CW, CO-142W, CO-142WDD, FI-120W, FI-200W, FI-200WL, FI-200WR, FI-48, FI-48B, FI-48W, FI-64, FI-64B, FI-64W, FI-80W, MF-120, MF-48, MF-64		

componentes mecánicos y accesorios aparatos

macánica de puertas

muelles

resortes enrollados

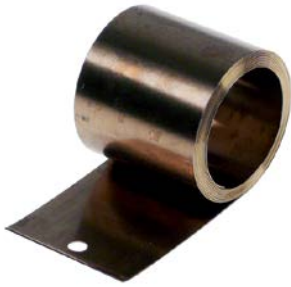

1

código	519451	referencia	12024689 Z270513
descripción	resorte enrollado An 40mm int.ø 35mm longitud de lengüeta 50mm		
Para modelos:	ECO-160, ECO-160D, ECO-160I, ECO-200, ECO-200D, ECO-200H, ECO-200HD, ECO-200HI, ECO-200I, ECO-2700D, ECO-2700I, ECO-280D, ECO-280I, ECO-370D, ECO-370I, ECO-4000D, ECO-4000I, ECO-460D, ECO-460I, ECO-550D, ECO-550I, ECO-6000D, ECO-6000I, FI-160, FI-160AR, FI-160D, FI-160I, FI-200, FI-200AR, FI-200D, FI-200H, FI-200HD, FI-200HI, FI-200I, FI-200W, FI-200WL, FI-200WR, FI-2700D, FI-2700I, FI-280D, FI-280I, FI-370D, FI-370I, FI-4000D, FI-4000I, FI-460D, FI-460I, FI-550D, FI-550I, FI-6000D...(Otros modelos se puede ver en la tienda web)		

placas de fricción



1

código	505195	referencia	12024180 Z200310
descripción	placa de fricción placa de fricción		
Para modelos:	AD-20C-UK, AD-21, AD-21B, AD-21BDD, AD-21C, AD-21D, AD-21DD, AD-21W, AD-45BBT, AD-48, AD-48B, AD-48BDD, AD-48C, AD-48D, AD-48DD, AD-48HY, AD-48W, AD-64, AD-64B, AD-64BDD, AD-64BDD, AD-64BTDD, AD-64C, AD-64CW, AD-64D, AD-64DD, AD-64HY, AD-72, AD-72W, EASY-500, EASY-500B, EASY-500DD, EASY-500HP, EASY-500HPWBDD, FI-30, FI-30AR, FI-30AR+DD, FI-30B, FI-30B-BT-UK, FI-30-UK, FI-48, FI-48AR, FI-48B, FI-48B-BT-UK, FI-48C, FI-48D, FI-48HY-CLINIC, FI-48W, FI-50, FI-60DD...(Otros modelos se puede ver en la tienda web)		

bisagras



1

código	505006	referencia	12022325 Z400515
descripción	bisagra de puerta bisagra/ derecha pos. de montaje derecho		
Para modelos:	AD-15, AD-15D, AD-20C-UK, AD-21, AD-21B, AD-21BDD, AD-21C, AD-21D, AD-21DD, AD-21W, AD-45BBT, AD-48, AD-48B, AD-48BDD, AD-48C, AD-48D, AD-48DD, AD-48HY, AD-48W, AD-64, AD-64B, AD-64BDD, AD-64BDD, AD-64BTDD, AD-64C, AD-64CW, AD-64D, AD-64DD, AD-64HY, AD-72, AD-72W, EASY-500, EASY-500B, EASY-500DD, EASY-500HP, EASY-500HPWBDD, FI-30, FI-30AR, FI-30AR+DD, FI-30B, FI-30B-BT-UK, FI-30-UK, FI-48, FI-48AR, FI-48B, FI-48B-BT-UK, FI-48C, FI-48D, FI-48HY-CLINIC, FI-48W...(Otros modelos se puede ver en la tienda web)		



1

código	505005	referencia	12022324 Z400514
descripción	bisagra de puerta bisagra/ izquierda pos. de montaje izquierdo		
Para modelos:	AD-15, AD-15D, AD-20C-UK, AD-21, AD-21B, AD-21BDD, AD-21C, AD-21D, AD-21DD, AD-21W, AD-45BBT, AD-48, AD-48B, AD-48BDD, AD-48C, AD-48D, AD-48DD, AD-48HY, AD-48W, AD-64, AD-64B, AD-64BDD, AD-64BDD, AD-64BTDD, AD-64C, AD-64CW, AD-64D, AD-64DD, AD-64HY, AD-72, AD-72W, EASY-500, EASY-500B, EASY-500DD, EASY-500HP, EASY-500HPWBDD, FI-30, FI-30AR, FI-30AR+DD, FI-30B, FI-30B-BT-UK, FI-30-UK, FI-48, FI-48AR, FI-48B, FI-48B-BT-UK, FI-48C, FI-48D, FI-48HY-CLINIC, FI-48W...(Otros modelos se puede ver en la tienda web)		
repuestos para	505005		
		código	700818
		referencia	12024071 Z400516
	perno de bisagra L 32mm acero inoxidable D1 ø 7.8mm D2 ø 12mm		



1

código	501479	referencia	12036714 12037269 6009990017 A169090003
descripción	bisagra de puerta L 130mm para frigorífico FAGOR		
Para modelos:	AEP-1402, AEP-1403, AEP-1404, AEP-1602, AEP-1603, AEP-1604, AEP-702, AEP-802, AF-1403-C, AF-1403-P, AF-1404-C, AF-1404-P, AF-1603-C, AF-1603-P, AF-1604-C, AF-1604-P, AF-2104-C, AF-2104-P, AF-2105-C, AF-2105-P, AF-2106-C, AF-2106-P, AFN-1402, AFN-1403, AFN-1404, AFN-1603, AFN-1604, AFN-702, AFN-802, AFP-1402, AFP-1403, AFP-1403-C, AFP-1403-FORZ, AFP-1403-P, AFP-1404, AFP-1404-C, AFP-1404-FORZ, AFP-1404-P, AFP-1603, AFP-1603-2, AFP-1604, AFP-2104, AFP-2104-C, AFP-2104-P, AFP-2105, AFP-2105-C, AFP-2105-P, AFP-2106, AFP-2106-C, AFP-2106-P...(Otros modelos se puede ver en la tienda web)		



puertas

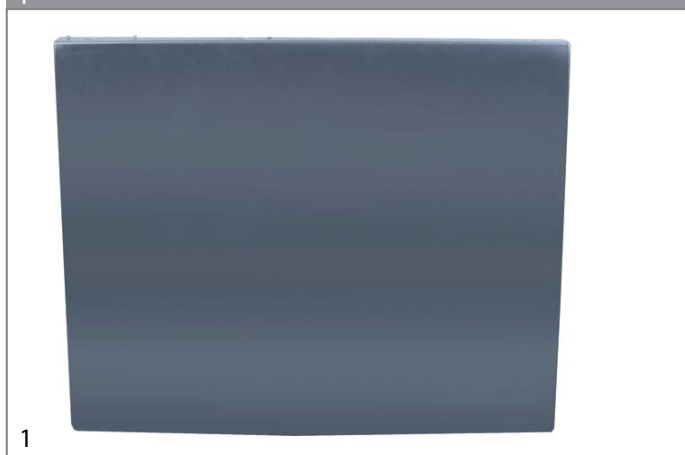

1

código	691912	referencia	12015781 Z420511
descripción	parte interior de puerta An 405mm H 340mm espesor 18mm FAGOR apto para LVC / LVR		
Para modelos:	LVC-21, LVC-21B, LVC-21D, LVC-21W, LVR-20, LVR-20B, LVR-20D, MF-21		



1

código	507443	referencia	12015782 Z420531
descripción	puerta An 455mm H 370mm espesor 35mm FAGOR apto para LVC / LVR		
Para modelos:	LVC-21, LVC-21B, LVC-21D, LVC-21W, LVR-20, LVR-20B, LVR-20D, MF-21		



1

código	507442	referencia	1200005030 12006603 12013502 12038302 12Z2005410
descripción	puerta An 585mm H 430mm espesor 50mm completo FAGOR		
Para modelos:	FI-30, FI-30AR, FI-30AR+DD, FI-30B, FI-30B-BT-UK, FI-30-UK, FI-48, FI-48AR, FI-48B, FI-48B-BT-UK, FI-48C, FI-48D, FI-48HY-CLINIC, FI-48W, FI-64, FI-64AR, FI-64B, FI-64B-BT-UK, FI-64C, FI-64D, FI-64HY-CLINIC, FI-64W		

guías de puertas



1

código	517826	referencia	12024682 Z270336 Z270336000
descripción	guía de puerta L 620mm An 37mm H 13mm pos. de montaje derecho		
Para modelos:	ECO-160, ECO-160D, ECO-160I, ECO-200, ECO-200D, ECO-200H, ECO-200HD, ECO-200HI, ECO-200I, ECO-280D, ECO-280I, ECO-370D, ECO-370I, ECO-460D, ECO-460I, ECO-550D, ECO-550I, FI-160, FI-160AR, FI-160D, FI-160I, FI-200, FI-200AR, FI-200D, FI-200H, FI-200HD, FI-200HI, FI-200I, FI-200W, FI-200WL, FI-200WR, FI-280D, FI-280I, FI-370D, FI-370I, FI-460D, FI-460I, FI-550D, FI-550I		



marco de puerta

			
1			
código	504239	referencia	12024295 Z200524
descripción	marco de puerta L 360mm An 15mm H 14mm plástico L-Form distancia de sujeción 150mm		
Para modelos:	AD-45BBT, AD-48, AD-48B, AD-48BDD, AD-48C, AD-48D, AD-48DD, AD-48HY, AD-48W, AD-64, AD-64B, AD-64BBT, AD-64BDD, AD-64BTDD, AD-64C, AD-64CW, AD-64D, AD-64DD, AD-64HY, EASY-500, EASY-500B, EASY-500DD, EASY-500HP, EASY-500HPWBDD, FI-30, FI-30AR, FI-30AR+DD, FI-30B, FI-30B-BT-UK, FI-30-UK, FI-48, FI-48AR, FI-48B, FI-48B-BT-UK, FI-48C, FI-48D, FI-48HY-CLINIC, FI-48W, FI-50, FI-60DD, FI-64, FI-64AR, FI-64B, FI-64B-BT-UK, FI-64C, FI-64D, FI-64HY-CLINIC, FI-64W, MF-48, MF-64		

soportes para barra de puerta

			
1			
código	505238	referencia	12008904 623600000
descripción	gancho L 245mm		
Para modelos:	CG-1002, CG-1502, CG-2002, CG-2002P, CG-210, CG-210G, CG-310, CG-310G		

topes de puerta

			
1			
código	506266	referencia	12016638 Z105042
descripción	tope de puerta H 28mm L 66mm An 7.5mm pos. de montaje puerta plástico		
Para modelos:	ECO-1600, ECO-2300, ECO-3000, FI-1600, FI-2300, FI-3000		

			
1			
código	505149	referencia	12024299 Z200522
descripción	tope de puerta tope de puerta		
Para modelos:	AD-20C-UK, AD-21, AD-21B, AD-21BDD, AD-21C, AD-21D, AD-21DD, AD-21W, AD-45BBT, AD-48, AD-48B, AD-48BDD, AD-48C, AD-48D, AD-48DD, AD-48HY, AD-48W, AD-64, AD-64B, AD-64BBT, AD-64BDD, AD-64BTDD, AD-64C, AD-64CW, AD-64D, AD-64DD, AD-64HY, AD-72, AD-72W, EASY-500, EASY-500B, EASY-500DD, EASY-500HP, EASY-500HPWBDD, FI-30, FI-30AR, FI-30AR+DD, FI-30B, FI-30B-BT-UK, FI-30-UK, FI-48, FI-48AR, FI-48B, FI-48B-BT-UK, FI-48C, FI-48D, FI-48HY-CLINIC, FI-48W, FI-50, FI-60DD...(Otros modelos se puede ver en la tienda web)		

cierres

			
1			
código	505196	referencia	12024235 Z200601
descripción	cierre de puerta		
Para modelos:	AD-15, AD-15D, AD-20C-UK, AD-21, AD-21B, AD-21BDD, AD-21C, AD-21D, AD-21DD, AD-21W, AD-45BBT, AD-48, AD-48B, AD-48BDD, AD-48C, AD-48D, AD-48DD, AD-48HY, AD-48W, AD-64, AD-64B, AD-64BBT, AD-64BDD, AD-64BTDD, AD-64C, AD-64CW, AD-64D, AD-64DD, AD-64HY, AD-72, AD-72W, EASY-500, EASY-500B, EASY-500DD, EASY-500HP, EASY-500HPWBDD, ECO-2700D, ECO-2700I, ECO-4000D, ECO-4000I, ECO-6000D, ECO-6000I, FI-2700D, FI-2700I, FI-30, FI-30AR, FI-30AR+DD, FI-30B, FI-30B-BT-UK, FI-30-UK...(Otros modelos se puede ver en la tienda web)		

			
1			
código	505007	referencia	12003212 12003363 12Z2006070
descripción	cierre de puerta cierre de puerta		
Para modelos:	AD-15, AD-15D, AD-20C-UK, AD-21, AD-21B, AD-21BDD, AD-21C, AD-21D, AD-21DD, AD-21W, AD-45BBT, AD-48, AD-48B, AD-48BDD, AD-48C, AD-48D, AD-48DD, AD-48HY, AD-48W, AD-64, AD-64B, AD-64BBT, AD-64BDD, AD-64BTDD, AD-64C, AD-64CW, AD-64D, AD-64DD, AD-64HY, AD-72, AD-72W, EASY-500, EASY-500B, EASY-500DD, EASY-500HP, EASY-500HPWBDD, ECO-2700D, ECO-2700I, ECO-4000D, ECO-4000I, ECO-6000D, ECO-6000I, FI-2700D, FI-2700I, FI-30, FI-30AR, FI-30AR+DD, FI-30B, FI-30B-BT-UK, FI-30-UK...(Otros modelos se puede ver en la tienda web)		

otros

			
1			
código	508396	referencia	12021923 Z710543
descripción	barra elástica recto acero inoxidable L 140mm An 24mm		
Para modelos:	AD-120, AD-120B, AD-120BBTDD-UK, AD-90, AD-90BA, AD-90BBT, AD-90BDD, AD-90DD, ADE-120, ADE-120B, ECO-120, ECO-120B, FI-100, FI-100AR, FI-100B, FI-100BBT-UK, FI-120, FI-120AR+DD, FI-120B, FI-120C, FI-120HY-CLINIC, FI-120W, FI-80, FI-80AR, FI-80BBT-UK, FI-80W, FI-E-100, LABP-1000, LABP-1200, LABP-800, MF-120		



			
1			
código	505008	referencia	12025166 Z710529
descripción	gancho tensor gancho tensor		
Para modelos:	AD-120, AD-120B, AD-120BBTDD-UK, AD-90, AD-90BA, AD-90BBT, AD-90BDD, AD-90DD, ADE-120, ADE-120B, ECO-120, ECO-120B, FI-100, FI-100AR, FI-100B, FI-100BBT-UK, FI-120, FI-120AR+DD, FI-120B, FI-120C, FI-120HY-CLINIC, FI-120W, FI-80, FI-80AR, FI-80BBT-UK, FI-80W, FI-E-100, LABP-1000, LABP-1200, LABP-800, MF-120		

			
1			
código	505010	referencia	12023624 Z710544
descripción	tornillo tornillo		
Para modelos:	AD-120, AD-120B, AD-120BBTDD-UK, AD-90, AD-90BA, AD-90BBT, AD-90BDD, AD-90DD, ADE-120, ADE-120B, ECO-120, ECO-120B, FI-100, FI-100AR, FI-100B, FI-100BBT-UK, FI-120, FI-120AR+DD, FI-120B, FI-120C, FI-120HY-CLINIC, FI-120W, FI-80, FI-80AR, FI-80BBT-UK, FI-80W, FI-E-100, LABP-1000, LABP-1200, LABP-800, MF-120		

uniones roscadas

			
1			
código	505163	referencia	12025276 Z602102
descripción	tuerca rosca 1½"		
Para modelos:	ECO-1200, ECO-1600, ECO-2300, ECO-2700D, ECO-2700I, ECO-280D, ECO-280I, ECO-3000, ECO-370D, ECO-370I, ECO-4000D, ECO-4000I, ECO-460D, ECO-460I, ECO-550D, ECO-550I, ECO-6000D, ECO-6000I, FI-1200, FI-1600, FI-2300, FI-2700D, FI-2700I, FI-280D, FI-280I, FI-3000, FI-300B, FI-300R, FI-370D, FI-370I, FI-4000D, FI-4000I, FI-460D, FI-460I, FI-550D, FI-550I, FI-6000D, FI-6000I, FI-650R, FI-900		

			
1			
código	504369	referencia	12007871 Q223023
descripción	tuerca rosca 5/8" tubo (22,7mm) H 7.3mm EC 32 latón UE 1 pzs		
Para modelos:	AD-120, AD-120B, AD-120BBTDD-UK, AD-120C, AD-120CW, AD-120HY, AD-90, AD-90BA, AD-90BBT, AD-90BDD, AD-90DD, ADE-120, ADE-120B, CO-142W, CO-142WDD, COP-174W, COP-174WHR, ECO-120, ECO-1200, ECO-120B, ECO-160, ECO-1600, ECO-160D, ECO-160I, ECO-200, ECO-200D, ECO-200H, ECO-200HD, ECO-200HI, ECO-200I, ECO-2300, ECO-2700D, ECO-2700I, ECO-280D, ECO-280I, ECO-3000, ECO-370D, ECO-370I, ECO-4000D, ECO-4000I, ECO-460D, ECO-460I, ECO-550D, ECO-550I, ECO-6000D, ECO-6000I, FI-100, FI-100AR, FI-100B, FI-100BBT-UK...(Otros modelos se puede ver en la tienda web)		

cortinas

cortinas

			
1			
código	533002	referencia	12039834 Z106405
descripción	cortina An 615mm H 400mm goma espesor 2.7mm		
Para modelos:	ECO-1600, ECO-2300, ECO-3000, FI-1600, FI-2300, FI-3000		

			
1			
código	533015	referencia	12003701 12006760 12012962 12Z2764290 Z276410
descripción	cortina An 620mm H 410mm espesor 1.6mm sistemas de lavado		
Para modelos:	ECO-160, ECO-160D, ECO-160I, ECO-200, ECO-200D, ECO-200H, ECO-200HD, ECO-200HI, ECO-200I, ECO-2700D, ECO-2700I, ECO-280D, ECO-280I, ECO-370D, ECO-370I, ECO-4000D, ECO-4000I, ECO-460D, ECO-460I, ECO-550D, ECO-550I, ECO-6000D, ECO-6000I, FI-160, FI-160AR, FI-160D, FI-160I, FI-200, FI-200AR, FI-200D, FI-200H, FI-200HD, FI-200HI, FI-200I, FI-200W, FI-200WL, FI-200WR, FI-2700D, FI-2700I, FI-280D, FI-280I, FI-370D, FI-370I, FI-4000D, FI-4000I, FI-460D, FI-460I, FI-550D, FI-550I, FI-6000D...(Otros modelos se puede ver en la tienda web)		

			
1			
código	533014	referencia	12006850 12012916 12Z2764190 Z276401
descripción	cortina An 620mm H 500mm espesor 1.4mm sistemas de lavado		
Para modelos:	ECO-160, ECO-160D, ECO-160I, ECO-200, ECO-200D, ECO-200H, ECO-200HD, ECO-200HI, ECO-200I, ECO-2700D, ECO-2700I, ECO-280D, ECO-280I, ECO-370D, ECO-370I, ECO-4000D, ECO-4000I, ECO-460D, ECO-460I, ECO-550D, ECO-550I, ECO-6000D, ECO-6000I, FI-160, FI-160D, FI-160I, FI-200, FI-200D, FI-200H, FI-200HD, FI-200HI, FI-200I, FI-200W, FI-2700D, FI-2700I, FI-280D, FI-280I, FI-370D, FI-370I, FI-4000D, FI-4000I, FI-460D, FI-460I, FI-550D, FI-550I, FI-6000D, FI-6000I		

sistemas de lavado y aclarado



1

código	505184	referencia	12024222 Z203013
descripción	armella		
Para modelos:	AD-120, AD-120B, AD-120BBTDD-UK, AD-120C, AD-120CW, AD-120HY, AD-15, AD-15D, AD-20C-UK, AD-21, AD-21B, AD-21BDD, AD-21C, AD-21D, AD-21DD, AD-21W, AD-45BBT, AD-48, AD-48B, AD-48BDD, AD-48C, AD-48D, AD-48DD, AD-48HY, AD-48W, AD-64, AD-64B, AD-64BBT, AD-64BDD, AD-64BTDD, AD-64C, AD-64CW, AD-64D, AD-64DD, AD-64HY, AD-72, AD-72W, AD-90, AD-90BA, AD-90BBT, AD-90BDD, AD-90DD, ADE-120, ADE-120B, EASY-500, EASY-500B, EASY-500DD, EASY-500HP, EASY-500HPWBDD, ECO-120...(Otros modelos se puede ver en la tienda web)		



1

código	505040	referencia	12023726 12110631 Z650704
descripción	casquillo para brazo de lavado		
Para modelos:	AD-45BBT, AD-48, AD-48B, AD-48BDD, AD-48C, AD-48D, AD-48DD, AD-48HY, AD-48W, AD-505, AD-505-SOFT, AD-64, AD-64B, AD-64BBT, AD-64BDD, AD-64BTDD, AD-64C, AD-64CW, AD-64D, AD-64DD, AD-64HY, AD-72, AD-72W, AD-90, AD-90BA, AD-90BBT, AD-90BDD, AD-90DD, CO-110, CO-110B, CO-110BDD, CO-110DD, CO-112, CO-112B, CO-112BDD, CO-112DD, CO-500, CO-500B, CO-500BDD, CO-500DD, CO-501, CO-501B, CO-501BDD, CO-501DD, CO-501-SOFT, CO-502B, CO-502BDD, CO-502DD, CO-502W, COP-503...(Otros modelos se puede ver en la tienda web)		



1

código	505041	referencia	12025116 Z710712
descripción	casquillo para brazo de lavado		
Para modelos:	AD-120, AD-120B, AD-120BBTDD-UK, AD-120C, AD-120CW, AD-120HY, AD-125, AD-125HRS, AD-125-SOFT, ADE-120, ADE-120B, CO-142W, CO-142WDD, CO-170, CO-170B, CO-170BDD, CO-170DD, CO-170HRS, CO-170HRSDD, CO-170HRS-SOFT, CO-170-SOFT, CO-172, CO-172B, CO-172BDD, CO-172DD, COP-173, COP-173B, COP-173BDD, COP-173DD, COP-173HRS, COP-173HRSDD, COP-173-SOFT, COP-174, COP-174B, COP-174BDD, COP-174DD, COP-174HRS, COP-174HRSDD, COP-174W, COP-174WHRS, ECO-120, ECO-120B, FI-100, FI-100AR, FI-100B, FI-100BBT-UK, FI-120, FI-120AR+DD, FI-120B, FI-120C...(Otros modelos se puede ver en la tienda web)		



1

código	501483	referencia	12024859 Z310753
descripción	distribuidor de lavabo cuádruple para lavavajillas H 29mm ø 45mm int.ø 30mm agujero ø 18mm rosca L 20mm		
Para modelos:	ECO-2700D, ECO-2700I, ECO-280D, ECO-280I, ECO-370D, ECO-370I, ECO-4000D, ECO-4000I, ECO-460D, ECO-460I, ECO-550D, ECO-550I, ECO-6000D, ECO-6000I, FI-2700D, FI-2700I, FI-280D, FI-280I, FI-370D, FI-370I, FI-4000D, FI-4000I, FI-460D, FI-460I, FI-550D, FI-550I, FI-6000D, FI-6000I		



1

código	505227	referencia	12019816 Z270731
descripción	junta para brazo de lavado ø 55mm int.ø 39mm espesor 10mm		
Para modelos:	ECO-160, ECO-160D, ECO-160I, ECO-200, ECO-200D, ECO-200H, ECO-200HD, ECO-200HI, ECO-200I, FI-160, FI-160D, FI-160I, FI-200, FI-200D, FI-200H, FI-200HD, FI-200HI, FI-200I, FI-200W		



1

código	507425	referencia	12018740 Z710707
descripción	orificio de paso D1 ø 38mm D2 ø 45mm L 72mm ø int. 1 31mm ø int. 2 39mm		
Para modelos:	ECO-120, ECO-120B, ECO-160D, ECO-160I, ECO-200D, ECO-200I, FI-100, FI-100AR, FI-100B, FI-120, FI-120AR+DD, FI-120B, FI-120C, FI-120HY-CLINIC, FI-120W, FI-160D, FI-160I, FI-200D, FI-200I, FI-E-100, MF-120		
repuestos para	507425	código	518080
		referencia	12023537 Z710708
	tuerca rosca 1½" EC 50 conducto espesor 15mm		



1

código	505089	referencia	12017331 Z401913
descripción	soporte de brazo de aclarado pos. de montaje arriba		
Para modelos:	LVR-10, LVR-14, LVR-20, LVR-20B		

componentes mecánicos y accesorios aparatos



1			
código	505134	referencia	12023115 12038952 Z821910
descripción	soporte de brazo de aclarado rosca M23x1,75 L 61mm EC 32 tubo ø 10mm		
Para modelos:	ECO-1200, ECO-1600, ECO-2300, ECO-2700D, ECO-2700I, ECO-280D, ECO-280I, ECO-3000, ECO-370D, ECO-370I, ECO-4000D, ECO-4000I, ECO-460D, ECO-460I, ECO-550D, ECO-550I, ECO-6000D, ECO-6000I, FI-1200, FI-1600, FI-2300, FI-2700D, FI-2700I, FI-280D, FI-280I, FI-3000, FI-370D, FI-370I, FI-4000D, FI-4000I, FI-460D, FI-460I, FI-550D, FI-550I, FI-6000D, FI-6000I, FI-900		

1			
código	501546	referencia	12048173
descripción	soporte de brazo de lavado pos. de montaje arriba ø 42mm H 78mm L1 340mm		
Para modelos:	AD-125, AD-125HRS, AD-125-SOFT, CO-110, CO-110B, CO-110BDD, CO-110DD, CO-112, CO-112B, CO-112BDD, CO-112DD, CO-170, CO-170B, CO-170BDD, CO-170DD, CO-170HRS, CO-170HRSDD, CO-170HRS-SOFT, CO-170-SOFT, CO-172, CO-172B, CO-172BDD, CO-172DD, COP-173, COP-173B, COP-173BDD, COP-173DD, COP-173HRS, COP-173HRSDD, COP-173-SOFT, COP-174, COP-174B, COP-174BDD, COP-174DD, COP-174HRS, COP-174HRSDD		

accesorios para	501546			
	código	532103	referencia	12049214
	junta tórica EPDM espesor 3.53mm int.ø 13.87mm UE 10 pzs			
	código	699343	referencia	12048366
	junta L 118mm An 73mm H 9mm espesor 9mm			

1				
código	505260	referencia	12024287 Z310721	
descripción	tapa terminal para brazo de lavado ø 32mm L 33mm para FAGOR			
Para modelos:	ECO-2700D, ECO-2700I, ECO-280D, ECO-280I, ECO-370D, ECO-370I, ECO-4000D, ECO-4000I, ECO-460D, ECO-460I, ECO-550D, ECO-550I, ECO-6000D, ECO-6000I, FI-2700D, FI-2700I, FI-280D, FI-280I, FI-370D, FI-370I, FI-4000D, FI-4000I, FI-460D, FI-460I, FI-550D, FI-550I, FI-6000D, FI-6000I			
accesorios para	505260			
	código	502036	referencia	—
	junta tórica EPDM espesor 2.62mm int.ø 28.25mm UE 1 pzs			

1			
código	505034	referencia	12009829 Q152016
descripción	tornillo de cabeza moleteada rosca M5 rosca L 7mm ø 20mm H 3mm inox		
Para modelos:	AD-120, AD-120B, AD-120BBTDD-UK, AD-120C, AD-120CW, AD-120HY, AD-15, AD-15D, AD-20C-UK, AD-21, AD-21B, AD-21BDD, AD-21C, AD-21D, AD-21DD, AD-21W, AD-45BBT, AD-48, AD-48B, AD-48BDD, AD-48C, AD-48D, AD-48DD, AD-48HY, AD-48W, AD-64, AD-64B, AD-64BBT, AD-64BDD, AD-64BTDD, AD-64C, AD-64CW, AD-64D, AD-64DD, AD-64HY, AD-72, AD-72W, AD-90, AD-90BA, AD-90BBT, AD-90BDD, AD-90DD, ADE-120, ADE-120B, CO-110, CO-110B, CO-110BDD, CO-110DD, CO-112, CO-112B...(Otros modelos se puede ver en la tienda web)		

1			
código	505181	referencia	12024059 Z410711
descripción	tubo de lavado L 530mm		
Para modelos:	AD-15, AD-15D, CO-350, CO-350-B, CO-350-B-DD, CO-350-COLD, CO-350-COLD-B, CO-350-COLD-B-DD, CO-350-COLD-DD, CO-350-DD, CO-352-COLD, CO-352-COLD-B, CO-352-COLD-B-DD, CO-352-COLD-DD, LVC-12, LVC-15, LVC-15D		

1			
código	505182	referencia	12025154 Z440711
descripción	tubo de lavado L 605mm		
Para modelos:	AD-20C-UK, AD-21, AD-21B, AD-21BDD, AD-21C, AD-21D, AD-21DD, AD-21W, CO-400, CO-400-B, CO-400-B-DD, CO-400-COLD, CO-400-COLD-B, CO-400-COLD-B-DD, CO-400-COLD-DD, CO-400-DD, CO-400-SOFT, CO-402-COLD, CO-402-COLD-B, CO-402-COLD-B-DD, CO-402-COLD-DD, CO-402W, LVC-21, LVC-21B, LVC-21C, LVC-21D, LVC-21W, MF-21		

1			
código	505169	referencia	12023699 Z200706
descripción	tubo de lavado L 681mm		
Para modelos:	AD-45BBT, AD-48, AD-48B, AD-48BDD, AD-48C, AD-48D, AD-48DD, AD-48HY, AD-48W, AD-64, AD-64B, AD-64BBT, AD-64BDD, AD-64BTDD, AD-64C, AD-64CW, AD-64D, AD-64DD, AD-64HY, EASY-500, EASY-500B, EASY-500DD, EASY-500HP, EASY-500HPWBDD, FI-30, FI-30AR, FI-30AR+DD, FI-30B, FI-30B-BT-UK, FI-30-UK, FI-48, FI-48AR, FI-48B, FI-48B-BT-UK, FI-48C, FI-48D, FI-48HY-CLINIC, FI-48W, FI-50, FI-60DD, FI-64, FI-64AR, FI-64B, FI-64B-BT-UK, FI-64C, FI-64D, FI-64HY-CLINIC, FI-64W, MF-48, MF-64		

componentes mecánicos y accesorios aparatos



código	505188	referencia	12024606 Z260701
descripción	tubo de lavado L 790mm		
Para modelos:	AD-72, AD-72W, FI-72, FI-72AR, FI-72W		



código	511991	referencia	12006587 12Z7107090
descripción	tubo de lavado ø 38mm L 730mm inox		
Para modelos:	AD-120, AD-120B, AD-120BBTDD-UK, AD-120C, AD-120CW, AD-120HY, AD-90, AD-90BA, AD-90BBT, AD-90BDD, AD-90DD, ADE-120, ADE-120B, ECO-120, ECO-120B, FI-100, FI-100AR, FI-100B, FI-100BBT-UK, FI-120, FI-120AR+DD, FI-120B, FI-120C, FI-120HY-CLINIC, FI-120W, FI-80, FI-80AR, FI-80BBT-UK, FI-80W, FI-E-100, LABP-1000, LABP-1200, LABP-800, MF-120		



código	505320	referencia	12040593 12Z3107010
descripción	tubo de lavado pos. de montaje abajo ø 53mm L 40mm apto para FAGOR		
Para modelos:	ECO-280D, ECO-280I, ECO-370D, ECO-370I, ECO-460D, ECO-460I, ECO-550D, ECO-550I, FI-280D, FI-280I, FI-370D, FI-370I, FI-460D, FI-460I, FI-550D, FI-550I		



código	505168	referencia	12017869 Z400708
descripción	tuerca		
Para modelos:	LVR-10, LVR-14, LVR-14D, LVR-20, LVR-20B, LVR-20D		



código	518080	referencia	12023537 Z710708
descripción	tuerca rosca 1½" EC 50 conducto espesor 15mm		
Para modelos:	AD-120, AD-120B, AD-120BBTDD-UK, AD-120C, AD-120CW, AD-120HY, AD-90, AD-90BA, AD-90BBT, AD-90BDD, AD-90DD, ADE-120, ADE-120B, ECO-120, ECO-120B, ECO-160, ECO-160D, ECO-160I, ECO-200, ECO-200D, ECO-200H, ECO-200HD, ECO-200HI, ECO-200I, ECO-370D, ECO-370I, ECO-550D, ECO-550I, FI-100, FI-100AR, FI-100B, FI-100BBT-UK, FI-120, FI-120AR+DD, FI-120B, FI-120C, FI-120HY-CLINIC, FI-120W, FI-160, FI-160AR, FI-160D, FI-160I, FI-200, FI-200AR, FI-200D, FI-200H, FI-200HD, FI-200HI, FI-200I, FI-200W...(Otros modelos se puede ver en la tienda web)		



código	505243	referencia	12009769 Q223108
descripción	tuerca de racor ø 14mm rosca M24x2,5		
Para modelos:	ECO-160, ECO-160D, ECO-160I, ECO-200, ECO-200D, ECO-200H, ECO-200HD, ECO-200HI, ECO-200I, ECO-2700D, ECO-2700I, ECO-280D, ECO-280I, ECO-370D, ECO-370I, ECO-4000D, ECO-4000I, ECO-460D, ECO-460I, ECO-550D, ECO-550I, ECO-6000D, ECO-6000I, FI-160, FI-160AR, FI-160D, FI-160I, FI-200, FI-200AR, FI-200D, FI-200H, FI-200HD, FI-200HI, FI-200I, FI-200W, FI-200WL, FI-200WR, FI-2700D, FI-2700I, FI-280D, FI-280I, FI-370D, FI-370I, FI-4000D, FI-4000I, FI-460D, FI-460I, FI-550D, FI-550I, FI-6000D...(Otros modelos se puede ver en la tienda web)		



código	505171	referencia	12017466 12020831 12024375 Z200705
descripción	tuerca moleteada rosca M14x1 ø 35mm H 5mm inox		
Para modelos:	AD-45BBT, AD-48, AD-48B, AD-48BDD, AD-48C, AD-48D, AD-48DD, AD-48HY, AD-48W, AD-64, AD-64B, AD-64BBT, AD-64BDD, AD-64BTDD, AD-64C, AD-64CW, AD-64D, AD-64DD, AD-64HY, AD-72, AD-72W, AD-90, AD-90BA, AD-90BBT, AD-90BDD, AD-90DD, EASY-500, EASY-500B, EASY-500DD, EASY-500HP, EASY-500HPWBDD, FI-30, FI-30AR, FI-30AR+DD, FI-30B, FI-30B-BT-UK, FI-30-UK, FI-48, FI-48AR, FI-48B, FI-48B-BT-UK, FI-48C, FI-48D, FI-48HY-CLINIC, FI-48W, FI-50, FI-60DD, FI-64, FI-64AR, FI-64B...(Otros modelos se puede ver en la tienda web)		

sistemas de lavado y aclarado (por fabricante)



FAGOR





código	505038	referencia	12011257 12025122 Z650716
descripción	brazo de lavado L 490mm boquillas 9 montaje ø 32mm pos. de montaje arriba/abajo		
Para modelos:	AD-45BBT, AD-48, AD-48B, AD-48BDD, AD-48C, AD-48D, AD-48DD, AD-48HY, AD-48W, AD-505, AD-505-SOFT, AD-64, AD-64B, AD-64BBT, AD-64BDD, AD-64BTDD, AD-64C, AD-64CW, AD-64D, AD-64DD, AD-64HY, AD-72, AD-72W, AD-90, AD-90BA, AD-90BBT, AD-90BDD, AD-90DD, CO-110, CO-110B, CO-110BDD, CO-110DD, CO-112, CO-112B, CO-112BDD, CO-112DD, CO-500, CO-500B, CO-500BDD, CO-500DD, CO-501, CO-501B, CO-501BDD, CO-501DD, CO-501-SOFT, CO-502B, CO-502BDD, CO-502DD, CO-502W, COP-503...(Otros modelos se puede ver en la tienda web)		





			
1			
código	505039	referencia	12003421 12038375 12Z7107010
descripción	brazo de lavado L 525mm boquillas 14 montaje ø 50mm pos. de montaje arriba/abajo		
Para modelos:	AD-120, AD-120B, AD-120BBTDD-UK, AD-120C, AD-120CW, AD-120HY, AD-125, AD-125HRS, AD-125-SOFT, ADE-120, ADE-120B, CO-142W, CO-142WDD, CO-170, CO-170B, CO-170BDD, CO-170DD, CO-170HRS, CO-170HRSDD, CO-170HRS-SOFT, CO-170-SOFT, CO-172, CO-172B, CO-172BDD, CO-172DD, COP-173, COP-173B, COP-173BDD, COP-173DD, COP-173HRS, COP-173HRSDD, COP-173-SOFT, COP-174, COP-174B, COP-174BDD, COP-174DD, COP-174HRS, COP-174HRSDD, COP-174W, COP-174WHRS, ECO-120, ECO-120B, FI-100, FI-100AR, FI-100B, FI-100BBT-UK, FI-120, FI-120AR+DD, FI-120B, FI-120C...(Otros modelos se puede ver en la tienda web)		

			
1			
código	505044	referencia	12024077 Z201905
descripción	boquilla de aclarado		
Para modelos:	AD-15, AD-15D, AD-90, AD-90BA, AD-90BBT, AD-90BDD, AD-90DD, EASY-500, EASY-500B, EASY-500DD, EASY-500HP, EASY-500HPWBDD, FI-30, FI-30AR, FI-30AR+DD, FI-30B, FI-30B-BT-UK, FI-30-UK, FI-48, FI-48AR, FI-48B, FI-48B-BT-UK, FI-48C, FI-48D, FI-48HY-CLINIC, FI-48W, FI-60DD, FI-80, FI-80AR, FI-80BBT-UK, FI-80W, FI-E-100, LABP-800, LVC-12, LVC-15, LVC-15D, LVC-21, LVC-21B, LVC-21C, LVC-21D, LVC-21W, LVR-10, LVR-14, LVR-20, LVR-20B, MF-21		
accesorios para	505044		
	código	505045	referencia
			12009912 Q307036
	junta tórica EPDM espesor 1.78mm int.ø 5.28mm UE 1 pzs		
	código	505046	referencia
			12024006 Z201906
	contrasporte boquilla de aclarado		

			
1			
código	505103	referencia	12024252 Z211903
descripción	boquilla de aclarado		
Para modelos:	AD-120, AD-120B, AD-120BBTDD-UK, AD-120C, AD-120CW, AD-120HY, AD-20C-UK, AD-21, AD-21B, AD-21BDD, AD-21C, AD-21D, AD-21DD, AD-21W, AD-45BBT, AD-48, AD-48B, AD-48BDD, AD-48C, AD-48D, AD-48DD, AD-48HY, AD-48W, AD-64, AD-64B, AD-64BBT, AD-64BDD, AD-64BTDD, AD-64C, AD-64CW, AD-64D, AD-64DD, AD-64HY, AD-72, AD-72W, AD-90, AD-90BA, AD-90BDD, AD-90DD, ADE-120, ADE-120B, CO-110, CO-110B, CO-110BDD, CO-110DD, CO-112, CO-112B, CO-112BDD, CO-112DD, CO-142W...(Otros modelos se puede ver en la tienda web)		

			
1			
código	505033	referencia	12023732 Z400709
descripción	boquilla de lavado		
Para modelos:	AD-15, AD-15D, AD-20C-UK, AD-21, AD-21B, AD-21BDD, AD-21C, AD-21D, AD-21DD, AD-21W, CO-350, CO-350-B, CO-350-B-DD, CO-350-COLD, CO-350-COLD-B, CO-350-COLD-B-DD, CO-350-COLD-DD, CO-350-DD, CO-352-COLD, CO-352-COLD-B, CO-352-COLD-B-DD, CO-352-COLD-DD, CO-400, CO-400-B, CO-400-B-DD, CO-400-COLD, CO-400-COLD-B, CO-400-COLD-B-DD, CO-400-COLD-DD, CO-400-DD, CO-400-SOFT, CO-402-COLD, CO-402-COLD-B, CO-402-COLD-B-DD, CO-402-COLD-DD, CO-402W, LVC-12, LVC-15, LVC-15D, LVC-21, LVC-21B, LVC-21C, LVC-21D, LVC-21W, LVR-10, LVR-14, LVR-14D, LVR-20, LVR-20B, LVR-20D...(Otros modelos se puede ver en la tienda web)		
accesorios para	505033		
	código	505031	referencia
			12023710 Z400711
	contrasporte		

			
1			
código	505065	referencia	12020476 Z411902
descripción	brazo de aclarado		
Para modelos:	CO-350, CO-350-B, CO-350-B-DD, CO-350-COLD, CO-350-COLD-B, CO-350-COLD-B-DD, CO-350-COLD-DD, CO-350-DD, CO-352-COLD, CO-352-COLD-B, CO-352-COLD-B-DD, CO-352-COLD-DD, LVC-12, LVC-15, LVC-15D		

			
1			
código	505042	referencia	12025253 Z461902
descripción	brazo de aclarado L 144mm boquillas 2 montaje ø 11.7mm pos. de montaje „A“		
Para modelos:	AD-15, AD-15D, LVC-12, LVC-15, LVC-15D		

			
1			
código	505063	referencia	12024137 Z461901
descripción	brazo de aclarado L 144mm boquillas 2 montaje ø 7mm pos. de montaje „B“		
Para modelos:	AD-15, AD-15D, LVC-12, LVC-15, LVC-15D		





			
1			
código	505066	referencia	12020475 Z411901
descripción	brazo de aclarado L 145mm		
Para modelos:	CO-350, CO-350-B, CO-350-B-DD, CO-350-COLD, CO-350-COLD-B, CO-350-COLD-B-DD, CO-350-COLD-DD, CO-350-DD, CO-352-COLD, CO-352-COLD-B, CO-352-COLD-B-DD, CO-352-COLD-DD, LVC-12, LVC-15, LVC-15D		

			
1			
código	505043	referencia	12022613 Z441901
descripción	brazo de aclarado L 166mm boquillas 2 montaje ø 11.5mm pos. de montaje „A“		
Para modelos:	AD-20C-UK, AD-21, AD-21B, AD-21BDD, AD-21C, AD-21D, AD-21DD, AD-21W, CO-400, CO-400-B, CO-400-B-DD, CO-400-COLD, CO-400-COLD-B, CO-400-COLD-B-DD, CO-400-COLD-DD, CO-400-DD, CO-400-SOFT, CO-402-COLD, CO-402-COLD-B, CO-402-COLD-B-DD, CO-402-COLD-DD, CO-402W, LVC-15D, LVC-21, LVC-21B, LVC-21C, LVC-21D, LVC-21W, MF-21		

			
1			
código	505064	referencia	12022710 Z441902
descripción	brazo de aclarado L 166mm boquillas 3 montaje ø 11.5mm pos. de montaje „B“		
Para modelos:	AD-20C-UK, AD-21, AD-21B, AD-21BDD, AD-21C, AD-21D, AD-21DD, AD-21W, CO-400, CO-400-B, CO-400-B-DD, CO-400-COLD, CO-400-COLD-B, CO-400-COLD-B-DD, CO-400-COLD-DD, CO-400-DD, CO-400-SOFT, CO-402-COLD, CO-402-COLD-B, CO-402-COLD-B-DD, CO-402-COLD-DD, CO-402W, LVC-15D, LVC-21, LVC-21B, LVC-21C, LVC-21D, LVC-21W, MF-21		

			
1			
código	505147	referencia	12019827 Z410706
descripción	brazo de lavado		
Para modelos:	CO-350, CO-350-B, CO-350-B-DD, CO-350-COLD, CO-350-COLD-B, CO-350-COLD-B-DD, CO-350-COLD-DD, CO-350-DD, CO-352-COLD, CO-352-COLD-B, CO-352-COLD-B-DD, CO-352-COLD-DD, LVC-12, LVC-15, LVC-15D		

			
1			
código	505054	referencia	12025251 Z460701
descripción	brazo de lavado L 140mm boquillas 2 montaje ø 21.5mm pos. de montaje „B“		
Para modelos:	AD-15, AD-15D, LVC-12, LVC-15, LVC-15D		

			
1			
código	505036	referencia	12024138 Z460702
descripción	brazo de lavado L 140mm boquillas 3 montaje ø 21.5mm pos. de montaje „A“		
Para modelos:	AD-15, AD-15D, LVC-12, LVC-15, LVC-15D		

			
1			
código	505037	referencia	12022381 Z440706
descripción	brazo de lavado L 163mm boquillas 3 montaje ø 18mm pos. de montaje „A“		
Para modelos:	AD-20C-UK, AD-21, AD-21B, AD-21BDD, AD-21C, AD-21D, AD-21DD, AD-21W, CO-400, CO-400-B, CO-400-B-DD, CO-400-COLD, CO-400-COLD-B, CO-400-COLD-B-DD, CO-400-COLD-DD, CO-400-DD, CO-400-SOFT, CO-402-COLD, CO-402-COLD-B, CO-402-COLD-B-DD, CO-402-COLD-DD, CO-402W, LVC-21, LVC-21B, LVC-21C, LVC-21D, LVC-21W, MF-21		



			
1			
código	505055	referencia	12022382 Z440707
descripción	brazo de lavado L 163mm boquillas 3 montaje ø 18mm pos. de montaje „B“		
Para modelos:	AD-20C-UK, AD-21, AD-21B, AD-21BDD, AD-21C, AD-21D, AD-21DD, AD-21W, CO-400, CO-400-B, CO-400-B-DD, CO-400-COLD, CO-400-COLD-B, CO-400-COLD-B-DD, CO-400-COLD-DD, CO-400-DD, CO-400-SOFT, CO-402-COLD, CO-402-COLD-B, CO-402-COLD-B-DD, CO-402-COLD-DD, CO-402W, LVC-21, LVC-21B, LVC-21C, LVC-21D, LVC-21W, MF-21		



			
código	505031	referencia	12023710 Z400711
descripción	contrasoporte		
Para modelos:	AD-15, AD-15D, AD-20C-UK, AD-21, AD-21B, AD-21BDD, AD-21C, AD-21D, AD-21DD, AD-21W, CO-350, CO-350-B, CO-350-B-DD, CO-350-COLD, CO-350-COLD-B, CO-350-COLD-B-DD, CO-350-COLD-DD, CO-350-DD, CO-352-COLD, CO-352-COLD-B, CO-352-COLD-B-DD, CO-352-COLD-DD, CO-400, CO-400-B, CO-400-B-DD, CO-400-COLD, CO-400-COLD-B, CO-400-COLD-B-DD, CO-400-COLD-DD, CO-400-DD, CO-400-SOFT, CO-402-COLD, CO-402-COLD-B, CO-402-COLD-B-DD, CO-402-COLD-DD, CO-402W, ECO-2700D, ECO-2700I, ECO-280D, ECO-280I, ECO-370D, ECO-370I, ECO-4000D, ECO-4000I, ECO-460D, ECO-460I, ECO-550D, ECO-550I, ECO-6000D, ECO-6000I...(Otros modelos se puede ver en la tienda web)		

			
código	505044	referencia	12024077 Z201905
descripción	boquilla de aclarado		
Para modelos:	AD-15, AD-15D, AD-90, AD-90BA, AD-90BBT, AD-90BDD, AD-90DD, EASY-500, EASY-500B, EASY-500DD, EASY-500HP, EASY-500HPWBDD, FI-30, FI-30AR, FI-30AR+DD, FI-30B, FI-30B-BT-UK, FI-30-UK, FI-48, FI-48AR, FI-48B, FI-48B-BT-UK, FI-48C, FI-48D, FI-48HY-CLINIC, FI-48W, FI-60DD, FI-80, FI-80AR, FI-80BBT-UK, FI-80W, FI-E-100, LABP-800, LVC-12, LVC-15, LVC-15D, LVC-21, LVC-21B, LVC-21C, LVC-21D, LVC-21W, LVR-10, LVR-14, LVR-20, LVR-20B, MF-21		

			
código	505046	referencia	12024006 Z201906
descripción	contrasoporte boquilla de aclarado		
Para modelos:	AD-15, AD-15D, AD-90, AD-90BA, AD-90BDD, AD-90DD, FI-30, FI-30AR, FI-30AR+DD, FI-30B, FI-30B-BT-UK, FI-30-UK, FI-48, FI-48AR, FI-48B, FI-48B-BT-UK, FI-48C, FI-48D, FI-48HY-CLINIC, FI-48W, FI-60DD, FI-80, FI-80AR, FI-80W, FI-E-100, LABP-800, LVC-12, LVC-15, LVC-15D, LVC-21, LVC-21B, LVC-21C, LVC-21D, LVC-21W, LVR-10, LVR-14, LVR-20, LVR-20B, MF-21		

accesorios para	505044		
	código	505045	referencia
			12009912 Q307036
	junta tórica EPDM espesor 1.78mm int.ø 5.28mm UE 1 pzs		
	código	505046	referencia
			12024006 Z201906
	contrasoporte boquilla de aclarado		

			
código	505068	referencia	12025216 Z410704
descripción	cruceta de brazo de lavado		
Para modelos:	AD-15, AD-15D, AD-20C-UK, AD-21, AD-21B, AD-21BDD, AD-21C, AD-21D, AD-21DD, AD-21W, CO-350, CO-350-B, CO-350-B-DD, CO-350-COLD, CO-350-COLD-B, CO-350-COLD-B-DD, CO-350-COLD-DD, CO-350-DD, CO-352-COLD, CO-352-COLD-B, CO-352-COLD-B-DD, CO-352-COLD-DD, CO-400, CO-400-B, CO-400-B-DD, CO-400-COLD, CO-400-COLD-B, CO-400-COLD-B-DD, CO-400-COLD-DD, CO-400-DD, CO-400-SOFT, CO-402-COLD, CO-402-COLD-B, CO-402-COLD-B-DD, CO-402-COLD-DD, CO-402W, LVC-12, LVC-15, LVC-15D, LVC-21, LVC-21B, LVC-21C, LVC-21D, LVC-21W, MF-21		
accesorios para	505068		
	código	505035	referencia
			12024086 Z410705
	cojinete		

			
código	505061	referencia	12022442 12113596 Z201902
descripción	brazo de aclarado L 220mm boquillas 3 montaje ø 11.7mm pos. de montaje izquierdo		
Para modelos:	AD-120, AD-120B, AD-120BBTDD-UK, AD-120C, AD-120CW, AD-120HY, AD-45BBT, AD-48, AD-48B, AD-48BDD, AD-48C, AD-48D, AD-48DD, AD-48HY, AD-48W, AD-64, AD-64B, AD-64BBT, AD-64BDD, AD-64BTDD, AD-64C, AD-64CW, AD-64D, AD-64DD, AD-64HY, AD-72, AD-72W, AD-90, AD-90BA, AD-90BBT, AD-90BDD, AD-90DD, ADE-120, ADE-120B, CO-110, CO-110B, CO-110BDD, CO-110DD, CO-112, CO-112B, CO-112BDD, CO-112DD, CO-142W, CO-142WDD, CO-170, CO-170B, CO-170BDD, CO-170DD, CO-170HRS, CO-170HRSDD...(Otros modelos se puede ver en la tienda web)		

			
código	505045	referencia	12009912 Q307036
descripción	junta tórica EPDM espesor 1.78mm int.ø 5.28mm UE 1 pzs		
Para modelos:	AD-15, AD-15D, AD-90, AD-90BA, AD-90BDD, AD-90DD, COG-202, EASY-500, EASY-500B, EASY-500DD, EASY-500HP, EASY-500HPWBDD, FI-30, FI-30AR, FI-30AR+DD, FI-30B, FI-30B-BT-UK, FI-30-UK, FI-48, FI-48AR, FI-48B, FI-48B-BT-UK, FI-48C, FI-48D, FI-48HY-CLINIC, FI-48W, FI-60DD, FI-80, FI-80AR, FI-80W, FI-E-100, HGC-20-21, HGP-10-21, HGP-20-21, HGV-20-21, LABP-800, LF-13MPP, LF-18MPP, LF-25MPP, LF-8MPP, LVC-12, LVC-15, LVC-15D, LVC-21, LVC-21B, LVC-21D, LVC-21W, LVR-10, LVR-14, LVR-20...(Otros modelos se puede ver en la tienda web)		

			
código	505062	referencia	12022441 12113595 Z201901
descripción	brazo de aclarado L 220mm boquillas 3 montaje ø 12mm pos. de montaje derecho		
Para modelos:	AD-120, AD-120B, AD-120BBTDD-UK, AD-120C, AD-120CW, AD-120HY, AD-45BBT, AD-48, AD-48B, AD-48BDD, AD-48C, AD-48D, AD-48DD, AD-48HY, AD-48W, AD-64, AD-64B, AD-64BBT, AD-64BDD, AD-64BTDD, AD-64C, AD-64CW, AD-64D, AD-64DD, AD-64HY, AD-72, AD-72W, AD-90, AD-90BA, AD-90BBT, AD-90BDD, AD-90DD, ADE-120, ADE-120B, CO-110, CO-110B, CO-110BDD, CO-110DD, CO-112, CO-112B, CO-112BDD, CO-112DD, CO-142W, CO-142WDD, CO-170, CO-170B, CO-170BDD, CO-170DD, CO-170HRS, CO-170HRSDD...(Otros modelos se puede ver en la tienda web)		

componentes mecánicos y accesorios aparatos

			
código	505046	referencia	12024006 Z201906
descripción	contraportante boquilla de aclarado		
Para modelos:	AD-15, AD-15D, AD-90, AD-90BA, AD-90BDD, AD-90DD, FI-30, FI-30AR, FI-30AR+DD, FI-30B, FI-30B-BT-UK, FI-30-UK, FI-48, FI-48AR, FI-48B, FI-48B-BT-UK, FI-48C, FI-48D, FI-48HY-CLINIC, FI-48W, FI-60DD, FI-80, FI-80AR, FI-80W, FI-E-100, LABP-800, LVC-12, LVC-15, LVC-15D, LVC-21, LVC-21B, LVC-21C, LVC-21D, LVC-21W, LVR-10, LVR-14, LVR-20, LVR-20B, MF-21		

			
código	505069	referencia	12024470 Z201903
descripción	empalme de brazo de aclarado pos. de montaje arriba/abajo ø 12mm H 22mm L 59mm		
Para modelos:	AD-120, AD-120B, AD-120BBTDD-UK, AD-120C, AD-120CW, AD-120HY, AD-45BBT, AD-48, AD-48B, AD-48BDD, AD-48C, AD-48D, AD-48DD, AD-48HY, AD-48W, AD-64, AD-64B, AD-64BBT, AD-64BDD, AD-64BTDD, AD-64C, AD-64CW, AD-64D, AD-64DD, AD-64HY, AD-72, AD-72W, AD-90, AD-90BA, AD-90BBT, AD-90BDD, AD-90DD, ADE-120, ADE-120B, CO-110, CO-110B, CO-110BDD, CO-110DD, CO-112, CO-112B, CO-112BDD, CO-112DD, CO-142W, CO-142WDD, CO-170, CO-170B, CO-170BDD, CO-170DD, CO-170HRS, CO-170HRSDD...(Otros modelos se puede ver en la tienda web)		
accesorios para	505069		
		código	560076
		referencia	12009852 12010293 Q152024
	tornillo de cabeza avellanada rosca M4 L 10mm inox DIN 963/ISO 2009 UE 20 pzs soporte ranura ø cabezal 7.5mm		



			
código	505045	referencia	12009912 Q307036
descripción	junta tórica EPDM espesor 1.78mm int.ø 5.28mm UE 1 pzs		
Para modelos:	AD-15, AD-15D, AD-90, AD-90BA, AD-90BDD, AD-90DD, COG-202, EASY-500, EASY-500B, EASY-500DD, EASY-500HP, EASY-500HPWBDD, FI-30, FI-30AR, FI-30AR+DD, FI-30B, FI-30B-BT-UK, FI-30-UK, FI-48, FI-48AR, FI-48B, FI-48B-BT-UK, FI-48C, FI-48D, FI-48HY-CLINIC, FI-48W, FI-60DD, FI-80, FI-80AR, FI-80W, FI-E-100, HGC-20-21, HGP-10-21, HGP-20-21, HGV-20-21, LABP-800, LF-13MPP, LF-18MPP, LF-25MPP, LF-8MPP, LVC-12, LVC-15, LVC-15D, LVC-21, LVC-21B, LVC-21D, LVC-21W, LVR-10, LVR-14, LVR-20...(Otros modelos se puede ver en la tienda web)		

			
código	505267	referencia	12017814 Z600705
descripción	boquilla de lavado para tubo ø 25mm		
Para modelos:	ECO-1200, FI-1200, FI-900		

			
código	505136	referencia	12018104 Z680742
descripción	brazo de lavado L 225mm boquillas 4 ø 25mm		
Para modelos:	ECO-1200, FI-1200, FI-900		

			
código	505217	referencia	12018636 Z680741
descripción	brazo de lavado L 225mm boquillas 4 ø 25mm		
Para modelos:	ECO-1200, FI-1200, FI-900		

			
código	505216	referencia	12039835 Z680745
descripción	cruceta de brazo de lavado L 90mm An 90mm H 38mm		
Para modelos:	ECO-1200, FI-1200, FI-900		

			
código	505044	referencia	12024077 Z201905
descripción	boquilla de aclarado		
Para modelos:	AD-15, AD-15D, AD-90, AD-90BA, AD-90BBT, AD-90BDD, AD-90DD, EASY-500, EASY-500B, EASY-500DD, EASY-500HP, EASY-500HPWBDD, FI-30, FI-30AR, FI-30AR+DD, FI-30B, FI-30B-BT-UK, FI-30-UK, FI-48, FI-48AR, FI-48B, FI-48B-BT-UK, FI-48C, FI-48D, FI-48HY-CLINIC, FI-48W, FI-60DD, FI-80, FI-80AR, FI-80BBT-UK, FI-80W, FI-E-100, LABP-800, LVC-12, LVC-15, LVC-15D, LVC-21, LVC-21B, LVC-21C, LVC-21D, LVC-21W, LVR-10, LVR-14, LVR-20, LVR-20B, MF-21		
accesorios para	505044		
		código	505045
		referencia	12009912 Q307036
	junta tórica EPDM espesor 1.78mm int.ø 5.28mm UE 1 pzs		
		código	505046
		referencia	12024006 Z201906
	contraportante boquilla de aclarado		

			
código	505045	referencia	12009912 Q307036
descripción	junta tórica EPDM espesor 1.78mm int.ø 5.28mm UE 1 pzs		



			
código	505067	referencia	12017301 Z401915
descripción	brazo de aclarado pos. de montaje arriba/abajo L 157mm montaje ø 11.5mm boquillas 4		
Para modelos:	LVR-10, LVR-14		





			
1			
código	505090	referencia	12040402 Z421904
descripción	brazo de aclarado pos. de montaje arriba/abajo L 175mm montaje ø 10mm boquillas 5		
Para modelos:	LVR-20, LVR-20B		

			
1			
código	505046	referencia	12024006 Z201906
descripción	contrasoporte boquilla de aclarado		
Para modelos:	AD-15, AD-15D, AD-90, AD-90BA, AD-90BDD, AD-90DD, FI-30, FI-30AR, FI-30AR+DD, FI-30B, FI-30B-BT-UK, FI-30-UK, FI-48, FI-48AR, FI-48B, FI-48B-BT-UK, FI-48C, FI-48D, FI-48HY-CLINIC, FI-48W, FI-60DD, FI-80, FI-80AR, FI-80W, FI-E-100, LABP-800, LVC-12, LVC-15, LVC-15D, LVC-21, LVC-21B, LVC-21C, LVC-21D, LVC-21W, LVR-10, LVR-14, LVR-20, LVR-20B, MF-21		

			
1			
código	505045	referencia	12009912 Q307036
descripción	junta tórica EPDM espesor 1.78mm int.ø 5.28mm UE 1 pzs		
Para modelos:	AD-15, AD-15D, AD-90, AD-90BA, AD-90BDD, AD-90DD, COG-202, EASY-500, EASY-500B, EASY-500DD, EASY-500HP, EASY-500HPWBDD, FI-30, FI-30AR, FI-30AR+DD, FI-30B, FI-30B-BT-UK, FI-30-UK, FI-48, FI-48AR, FI-48B, FI-48B-BT-UK, FI-48C, FI-48D, FI-48HY-CLINIC, FI-48W, FI-60DD, FI-80, FI-80AR, FI-80W, FI-E-100, HGC-20-21, HGP-10-21, HGV-20-21, HGV-20-21, LABP-800, LF-13MPP, LF-18MPP, LF-25MPP, LF-8MPP, LVC-12, LVC-15, LVC-15D, LVC-21, LVC-21B, LVC-21D, LVC-21W, LVR-10, LVR-14, LVR-20...(Otros modelos se puede ver en la tienda web)		

			
1			
código	505044	referencia	12024077 Z201905
descripción	boquilla de aclarado		
Para modelos:	AD-15, AD-15D, AD-90, AD-90BA, AD-90BBT, AD-90BDD, AD-90DD, EASY-500, EASY-500B, EASY-500DD, EASY-500HP, EASY-500HPWBDD, FI-30, FI-30AR, FI-30AR+DD, FI-30B, FI-30B-BT-UK, FI-30-UK, FI-48, FI-48AR, FI-48B, FI-48B-BT-UK, FI-48C, FI-48D, FI-48HY-CLINIC, FI-48W, FI-60DD, FI-80, FI-80AR, FI-80BBT-UK, FI-80W, FI-E-100, LABP-800, LVC-12, LVC-15, LVC-15D, LVC-21, LVC-21B, LVC-21C, LVC-21D, LVC-21W, LVR-10, LVR-14, LVR-20, LVR-20B, MF-21		
accesorios para	505044		
	código	505045	referencia 12009912 Q307036
	junta tórica EPDM espesor 1.78mm int.ø 5.28mm UE 1 pzs		
	código	505046	referencia 12024006 Z201906
	contrasoporte boquilla de aclarado		

			
1			
código	505265	referencia	12023524 Z208712
descripción	brazo de aclarado L 230mm boquillas 3		
Para modelos:	AD-90, AD-90BA, AD-90BBT, AD-90BDD, AD-90DD, EASY-500, EASY-500B, EASY-500DD, EASY-500HP, EASY-500HPWBDD, FI-30, FI-30AR, FI-30AR+DD, FI-30B, FI-30B-BT-UK, FI-30-UK, FI-48, FI-48AR, FI-48B, FI-48B-BT-UK, FI-48C, FI-48D, FI-48HY-CLINIC, FI-48W, FI-60DD, FI-80, FI-80AR, FI-80W, FI-E-100, LABP-800		

			
1			
código	505266	referencia	12023527 Z208713
descripción	brazo de aclarado L 230mm boquillas 3 derecho		
Para modelos:	AD-90, AD-90BA, AD-90BBT, AD-90BDD, AD-90DD, EASY-500, EASY-500B, EASY-500DD, EASY-500HP, EASY-500HPWBDD, FI-30, FI-30AR, FI-30AR+DD, FI-30B, FI-30B-BT-UK, FI-30-UK, FI-48, FI-48AR, FI-48B, FI-48B-BT-UK, FI-48C, FI-48D, FI-48HY-CLINIC, FI-48W, FI-60DD, FI-80, FI-80AR, FI-80W, FI-E-100, LABP-800		

			
1			
código	505046	referencia	12024006 Z201906
descripción	contrasoporte boquilla de aclarado		
Para modelos:	AD-15, AD-15D, AD-90, AD-90BA, AD-90BDD, AD-90DD, FI-30, FI-30AR, FI-30AR+DD, FI-30B, FI-30B-BT-UK, FI-30-UK, FI-48, FI-48AR, FI-48B, FI-48B-BT-UK, FI-48C, FI-48D, FI-48HY-CLINIC, FI-48W, FI-60DD, FI-80, FI-80AR, FI-80W, FI-E-100, LABP-800, LVC-12, LVC-15, LVC-15D, LVC-21, LVC-21B, LVC-21C, LVC-21D, LVC-21W, LVR-10, LVR-14, LVR-20, LVR-20B, MF-21		

			
1			
código	505069	referencia	12024470 Z201903
descripción	empalme de brazo de aclarado pos. de montaje arriba/abajo ø 12mm H 22mm L 59mm		
Para modelos:	AD-120, AD-120B, AD-120BBTDD-UK, AD-120C, AD-120CW, AD-120HY, AD-45BBT, AD-48, AD-48B, AD-48BDD, AD-48C, AD-48D, AD-48DD, AD-48HY, AD-48W, AD-64, AD-64B, AD-64BBT, AD-64BDD, AD-64BTDD, AD-64C, AD-64CW, AD-64D, AD-64DD, AD-64HY, AD-72, AD-72W, AD-90, AD-90BA, AD-90BBT, AD-90BDD, AD-90DD, ADE-120, ADE-120B, CO-110, CO-110B, CO-110BDD, CO-110DD, CO-112, CO-112B, CO-112BDD, CO-112DD, CO-142W, CO-142WDD, CO-170, CO-170B, CO-170BDD, CO-170DD, CO-170HRS, CO-170HRSDD...(Otros modelos se puede ver en la tienda web)		
accesorios para	505069		
	código	560076	referencia 12009852 12010293 Q152024
	tornillo de cabeza avellanada rosca M4 L 10mm inox DIN 963/ISO 2009 UE 20 pzs soporte ranura ø cabezal 7.5mm		

componentes mecánicos y accesorios aparatos

			
1			
código	505045	referencia	12009912 Q307036
descripción	junta tórica EPDM espesor 1.78mm int.ø 5.28mm UE 1 pzs		
Para modelos:	AD-15, AD-15D, AD-90, AD-90BA, AD-90BDD, AD-90DD, COG-202, EASY-500, EASY-500B, EASY-500DD, EASY-500HP, EASY-500HPWBDD, FI-30, FI-30AR, FI-30AR+DD, FI-30B, FI-30B-BT-UK, FI-30-UK, FI-48, FI-48AR, FI-48B, FI-48B-BT-UK, FI-48C, FI-48D, FI-48HY-CLINIC, FI-48W, FI-60DD, FI-80, FI-80AR, FI-80W, FI-E-100, HGC-20-21, HGP-10-21, HGP-20-21, HGV-20-21, LABP-800, LF-13MPP, LF-18MPP, LF-25MPP, LF-8MPP, LVC-12, LVC-15, LVC-15D, LVC-21, LVC-21B, LVC-21D, LVC-21W, LVR-10, LVR-14, LVR-20...(Otros modelos se puede ver en la tienda web)		

			
1			
código	507537	referencia	12007166 12Z3119100
descripción	brazo de aclarado An 630mm H 645mm boquillas 12		
Para modelos:	ECO-280D, ECO-280I, ECO-370D, ECO-370I, ECO-460D, ECO-460I, ECO-550D, ECO-550I, FI-280D, FI-280I, FI-370D, FI-370I, FI-460D, FI-460I, FI-550D, FI-550I		



			
1			
código	505231	referencia	12021106 Z791931
descripción	boquilla de aclarado ø 14mm H 22mm rosca M10x0,9		
Para modelos:	ECO-1600, ECO-2300, ECO-3000, FI-1600, FI-2300, FI-3000		

			
1			
código	505258	referencia	12023568 Z311831
descripción	boquilla de lavado		
Para modelos:	ECO-2700D, ECO-2700I, ECO-280D, ECO-280I, ECO-370D, ECO-370I, ECO-4000D, ECO-4000I, ECO-460D, ECO-460I, ECO-550D, ECO-550I, ECO-6000D, ECO-6000I, FI-2700D, FI-2700I, FI-280D, FI-280I, FI-370D, FI-370I, FI-4000D, FI-4000I, FI-460D, FI-460I, FI-550D, FI-550I, FI-6000D, FI-6000I		

			
1			
código	505031	referencia	12023710 Z400711
descripción	contrasoporte		
Para modelos:	AD-15, AD-15D, AD-20C-UK, AD-21, AD-21B, AD-21BDD, AD-21C, AD-21D, AD-21DD, AD-21W, CO-350, CO-350-B, CO-350-B-DD, CO-350-COLD, CO-350-COLD-B, CO-350-COLD-B-DD, CO-350-COLD-DD, CO-350-DD, CO-352-COLD, CO-352-COLD-B, CO-352-COLD-B-DD, CO-352-COLD-DD, CO-400, CO-400-B, CO-400-B-DD, CO-400-COLD, CO-400-COLD-B, CO-400-COLD-B-DD, CO-400-COLD-DD, CO-400-DD, CO-400-SOFT, CO-402-COLD, CO-402-COLD-B, CO-402-COLD-B-DD, CO-402-COLD-DD, CO-402W, ECO-2700D, ECO-2700I, ECO-280D, ECO-280I, ECO-370D, ECO-370I, ECO-4000D, ECO-4000I, ECO-460D, ECO-460I, ECO-550D, ECO-550I, ECO-6000D, ECO-6000I...(Otros modelos se puede ver en la tienda web)		

			
1			
código	510116	referencia	12017168 Z100709
descripción	boquilla de lavado pos. de montaje arriba H 37mm tipo B tubo ø 37mm		
Para modelos:	ECO-1600, ECO-2300, ECO-3000, FI-1600, FI-2300, FI-3000		

			
1			
código	505233	referencia	12020338 Z100706
descripción	brazo de lavado con brida L 180mm		
Para modelos:	ECO-1600, ECO-2300, ECO-3000, FI-1600, FI-2300, FI-3000		

				
1				
código	505319	referencia	12020529 Z100705	
descripción	brazo de lavado con brida L 255mm boquillas 3			
Para modelos:	ECO-1600, ECO-2300, ECO-3000, FI-1600, FI-2300, FI-3000			
accesorios para	505319			
	código	505324	referencia	12017004 Z100707
tapa terminal para brazo de lavado fijación atornillada H 13mm EC 42				
	código	510116	referencia	12017168 Z100709
boquilla de lavado pos. de montaje arriba H 37mm tipo B tubo ø 37mm				

			
1			
código	505324	referencia	12017004 Z100707
descripción	tapa terminal para brazo de lavado fijación atornillada H 13mm EC 42		
Para modelos:	ECO-1600, ECO-2300, ECO-3000, FI-1600, FI-2300, FI-3000		

otros			
			
1			
código	505215	referencia	12017837 Z600704
descripción	boquilla de lavado		



			
1			
código	505334	referencia	12024302 Z270721
descripción	tapa terminal para brazo de lavado ø 27mm L 33mm para FAGOR		
Para modelos:	ECO-160, ECO-160D, ECO-160I, ECO-200, ECO-200D, ECO-200H, ECO-200HD, ECO-200HI, ECO-200I, FI-160, FI-160AR, FI-160D, FI-160I, FI-200, FI-200AR, FI-200D, FI-200H, FI-200HD, FI-200HI, FI-200I, FI-200W, FI-200WL, FI-200WR		
accesorios para	505334		
			
	código	532499	referencia
			12010230 Q307062
	junta tórica EPDM espesor 2.62mm int.ø 23.47mm UE 1 pzs		

			
1			
código	505051	referencia	12023613 Z200703
descripción	contrasoporte pos. de montaje abajo para soporte de brazo de lavado		
Para modelos:	AD-45BBT, AD-48, AD-48B, AD-48BDD, AD-48C, AD-48D, AD-48DD, AD-48HY, AD-48W, AD-64, AD-64B, AD-64BBT, AD-64BDD, AD-64BTDD, AD-64C, AD-64CW, AD-64D, AD-64DD, AD-64HY, AD-72, AD-72W, EASY-500, EASY-500B, EASY-500DD, EASY-500HP, EASY-500HPWBDD, FI-30, FI-30AR, FI-30AR+DD, FI-30B, FI-30B-BT-UK, FI-30-UK, FI-48, FI-48AR, FI-48B, FI-48B-BT-UK, FI-48C, FI-48D, FI-48HY-CLINIC, FI-48W, FI-50, FI-60DD, FI-64, FI-64AR, FI-64B, FI-64B-BT-UK, FI-64C, FI-64D, FI-64HY-CLINIC, FI-64W...(Otros modelos se puede ver en la tienda web)		

soportes brazo de lavado

			
1			
código	505020	referencia	12016686 Z400702
descripción	contrasoporte pos. de montaje abajo		
Para modelos:	LVR-10, LVR-14, LVR-14D, LVR-20, LVR-20B, LVR-20D		

			
1			
código	505017	referencia	12020347 Z400701
descripción	soporte de brazo de lavado pos. de montaje abajo		
Para modelos:	LVR-10, LVR-14, LVR-14D, LVR-20, LVR-20B, LVR-20D		

			
1			
código	505021	referencia	12024312 Z710706
descripción	contrasoporte pos. de montaje abajo		
Para modelos:	AD-120, AD-120B, AD-120BBTDD-UK, AD-120C, AD-120CW, AD-120HY, AD-90, AD-90BA, AD-90BBT, AD-90BDD, AD-90DD, ADE-120, ADE-120B, ECO-120, ECO-120B, FI-100, FI-100AR, FI-100B, FI-100BBT-UK, FI-120, FI-120AR+DD, FI-120B, FI-120C, FI-120HY-CLINIC, FI-120W, FI-80, FI-80AR, FI-80BBT-UK, FI-80W, FI-E-100, LABP-1000, LABP-1200, LABP-800, MF-120		

			
1			
código	505018	referencia	12024480 Z200701 Z210701
descripción	soporte de brazo de lavado pos. de montaje abajo		
Para modelos:	AD-45BBT, AD-48, AD-48B, AD-48BDD, AD-48C, AD-48D, AD-48DD, AD-48HY, AD-48W, AD-64, AD-64B, AD-64BBT, AD-64BDD, AD-64BTDD, AD-64C, AD-64CW, AD-64D, AD-64DD, AD-64HY, AD-72, AD-72W, EASY-500, EASY-500B, EASY-500DD, EASY-500HP, EASY-500HPWBDD, FI-30, FI-30AR, FI-30AR+DD, FI-30B, FI-30B-BT-UK, FI-30-UK, FI-48, FI-48AR, FI-48B, FI-48B-BT-UK, FI-48C, FI-48D, FI-48HY-CLINIC, FI-48W, FI-50, FI-60DD, FI-64, FI-64AR, FI-64B, FI-64B-BT-UK, FI-64C, FI-64D, FI-64HY-CLINIC, FI-64W...(Otros modelos se puede ver en la tienda web)		

			
1			
código	505053	referencia	12024703 Z410702
descripción	contrasoporte pos. de montaje abajo		
Para modelos:	AD-15, AD-15D, AD-20C-UK, AD-21, AD-21B, AD-21BDD, AD-21C, AD-21D, AD-21DD, AD-21W, CO-350, CO-350-B, CO-350-B-DD, CO-350-COLD, CO-350-COLD-B, CO-350-COLD-B-DD, CO-350-COLD-DD, CO-350-DD, CO-352-COLD, CO-352-COLD-B, CO-352-COLD-B-DD, CO-352-COLD-DD, CO-400, CO-400-B, CO-400-B-DD, CO-400-COLD, CO-400-COLD-B, CO-400-COLD-B-DD, CO-400-COLD-DD, CO-400-DD, CO-400-SOFT, CO-402-COLD, CO-402-COLD-B, CO-402-COLD-B-DD, CO-402-COLD-DD, CO-402W, LVC-12, LVC-15, LVC-15D, LVC-21, LVC-21B, LVC-21C, LVC-21D, LVC-21W, MF-21		

			
1			
código	505019	referencia	12020989 12025170 Z740702 Z740705
descripción	soporte de brazo de lavado pos. de montaje abajo		
Para modelos:	AD-90, AD-90BA, AD-90BBT, AD-90BDD, AD-90DD, FI-80, FI-80AR, FI-80BBT-UK, FI-80W, FI-E-100, LABP-800		



código	505022	referencia	12023652 Z710704
descripción	soporte de brazo de lavado pos. de montaje abajo		
Para modelos:	AD-120, AD-120B, AD-120BBTDD-UK, AD-120C, AD-120CW, AD-120HY, ADE-120, ADE-120B, ECO-120, ECO-120B, FI-100, FI-100AR, FI-100B, FI-120, FI-120AR+DD, FI-120B, FI-120C, FI-120HY-CLINIC, FI-120W, FI-E-100, LABP-1200, MF-120		



código	505275	referencia	12024478 Z710719
descripción	soporte de brazo de lavado pos. de montaje arriba D1 ø 47mm H 91mm L1 86mm		
Para modelos:	FI-100, FI-100AR, FI-100B, FI-100BBT-UK, LABP-1000		



código	505050	referencia	12025133 Z410701
descripción	soporte de brazo de lavado pos. de montaje arriba H 102mm D1 ø 40mm D2 ø 48mm D3 ø 68mm		
Para modelos:	AD-15, AD-15D, AD-20C-UK, AD-21, AD-21B, AD-21BDD, AD-21C, AD-21D, AD-21DD, AD-21W, LVC-12, LVC-15, LVC-15D, LVC-21, LVC-21B, LVC-21C, LVC-21D, LVC-21W, MF-21		



código	505056	referencia	12023590 Z410703
descripción	soporte de brazo de lavado pos. de montaje arriba		
Para modelos:	AD-15, AD-15D, AD-20C-UK, AD-21, AD-21B, AD-21BDD, AD-21C, AD-21D, AD-21DD, AD-21W, LVC-12, LVC-15, LVC-15D, LVC-21, LVC-21B, LVC-21C, LVC-21D, LVC-21W, MF-21		



código	505057	referencia	12024471 Z200707
descripción	soporte de brazo de lavado pos. de montaje arriba		
Para modelos:	AD-45BBT, AD-48, AD-48B, AD-48BDD, AD-48C, AD-48D, AD-48DD, AD-48HY, AD-48W, AD-64, AD-64B, AD-64BBT, AD-64BDD, AD-64BTDD, AD-64C, AD-64CW, AD-64D, AD-64DD, AD-64HY, AD-72, AD-72W, EASY-500, EASY-500B, EASY-500DD, EASY-500HP, EASY-500HPWBDD, FI-30, FI-30AR, FI-30AR+DD, FI-30B, FI-30B-BT-UK, FI-30-UK, FI-48, FI-48AR, FI-48B, FI-48B-BT-UK, FI-48C, FI-48D, FI-48HY-CLINIC, FI-48W, FI-50, FI-60DD, FI-64, FI-64AR, FI-64B, FI-64B-BT-UK, FI-64C, FI-64D, FI-64HY-CLINIC, FI-64W...(Otros modelos se puede ver en la tienda web)		



código	505059	referencia	12024927 Z710703
descripción	soporte de brazo de lavado pos. de montaje arriba		
Para modelos:	AD-120BBTDD-UK, AD-90, AD-90BA, AD-90BBT, AD-90BDD, AD-90DD, FI-80, FI-80AR, FI-80BBT-UK, FI-80W, FI-E-100, LABP-800		





código	505060	referencia	12024934 Z710705
descripción	soporte de brazo de lavado pos. de montaje arriba		
Para modelos:	AD-120, AD-120B, AD-120BBTDD-UK, AD-120C, AD-120CW, AD-120HY, AD-90, AD-90BA, AD-90BDD, AD-90DD, ADE-120, ADE-120B, CO-142W, CO-142WDD, COP-174W, COP-174WHR, ECO-120, ECO-120B, FI-100, FI-100AR, FI-100B, FI-100BBT-UK, FI-120, FI-120AR+DD, FI-120B, FI-120C, FI-120HY-CLINIC, FI-120W, FI-E-100, LABP-1000, LABP-1200, LABP-800, MF-120		



código	501546	referencia	12048173
descripción	soporte de brazo de lavado pos. de montaje arriba ø 42mm H 78mm L1 340mm		
Para modelos:	AD-125, AD-125HRS, AD-125-SOFT, CO-110, CO-110B, CO-110BDD, CO-110DD, CO-112, CO-112B, CO-112BDD, CO-112DD, CO-170, CO-170B, CO-170BDD, CO-170DD, CO-170HRS, CO-170HRSSD, CO-170HRS-SOFT, CO-170-SOFT, CO-172, CO-172B, CO-172BDD, CO-172DD, COP-173, COP-173B, COP-173BDD, COP-173DD, COP-173HRS, COP-173HRSSD, COP-173-SOFT, COP-174, COP-174B, COP-174BDD, COP-174DD, COP-174HRS, COP-174HRSSD		

accesorios para 501546

código	532103	referencia	12049214
	junta tórica EPDM espesor 3.53mm int.ø 13.87mm UE 10 pzs		
código	699343	referencia	12048366
	junta L 118mm An 73mm H 9mm espesor 9mm		

pernos de aclarado



código	505047	referencia	12025114 Z410708
descripción	perno de aclarado		
Para modelos:	AD-15, AD-15D, AD-20C-UK, AD-21, AD-21B, AD-21BDD, AD-21C, AD-21D, AD-21DD, AD-21W, CO-350, CO-350-B, CO-350-B-DD, CO-350-COLD, CO-350-COLD-B, CO-350-COLD-B-DD, CO-350-COLD-DD, CO-350-DD, CO-352-COLD, CO-352-COLD-B, CO-352-COLD-B-DD, CO-352-COLD-DD, CO-400, CO-400-B, CO-400-B-DD, CO-400-COLD, CO-400-COLD-B, CO-400-COLD-B-DD, CO-400-COLD-DD, CO-400-DD, CO-400-SOFT, CO-402-COLD, CO-402-COLD-B, CO-402-COLD-B-DD, CO-402-COLD-DD, CO-402W, LVC-12, LVC-15, LVC-15D, LVC-21, LVC-21B, LVC-21C, LVC-21D, LVC-21W, MF-21		



			
1			
código	505048	referencia	12023844 Z200704
descripción	perno de aclarado		
Para modelos:	AD-45BBT, AD-48, AD-48B, AD-48BDD, AD-48C, AD-48D, AD-48DD, AD-48HY, AD-48W, AD-64, AD-64B, AD-64BBT, AD-64BDD, AD-64BTDD, AD-64C, AD-64CW, AD-64D, AD-64DD, AD-64HY, AD-72, AD-72W, AD-90, AD-90BA, AD-90BBT, AD-90BDD, AD-90DD, EASY-500, EASY-500B, EASY-500DD, EASY-500HP, EASY-500HPWBDD, FI-30, FI-30AR, FI-30AR+DD, FI-30B, FI-30B-BT-UK, FI-30-UK, FI-48, FI-48AR, FI-48B, FI-48B-BT-UK, FI-48C, FI-48D, FI-48HY-CLINIC, FI-48W, FI-50, FI-60DD, FI-64, FI-64AR, FI-64B...(Otros modelos se puede ver en la tienda web)		

			
1			
código	505049	referencia	12023601 Z710711
descripción	perno de aclarado		
Para modelos:	AD-120, AD-120B, AD-120BBTDD-UK, AD-120C, AD-120CW, AD-120HY, ADE-120, ADE-120B, ECO-120, ECO-120B, FI-100, FI-100AR, FI-100B, FI-100BBT-UK, FI-120, FI-120AR+DD, FI-120B, FI-120C, FI-120HY-CLINIC, FI-120W, FI-E-100, LABP-1000, LABP-1200, MF-120		

			
1			
código	513122	referencia	12029990 EU926130
descripción	perno de aclarado		

			
1			
código	505251	referencia	12018232 Z680748
descripción	perno de aclarado H 85mm		
Para modelos:	ECO-1200, FI-1200, FI-900		

			
1			
código	505052	referencia	12023801 Z410712
descripción	perno de aclarado L1 102mm L2 84mm L3 26mm		
Para modelos:	AD-15, AD-15D, AD-20C-UK, AD-21, AD-21B, AD-21BDD, AD-21C, AD-21D, AD-21DD, AD-21W, CO-350, CO-350-B, CO-350-B-DD, CO-350-COLD, CO-350-COLD-B, CO-350-COLD-B-DD, CO-350-COLD-DD, CO-350-DD, CO-352-COLD, CO-352-COLD-B, CO-352-COLD-B-DD, CO-352-COLD-DD, CO-400, CO-400-B, CO-400-B-DD, CO-400-COLD, CO-400-COLD-B, CO-400-COLD-B-DD, CO-400-COLD-DD, CO-400-DD, CO-400-SOFT, CO-402-COLD, CO-402-COLD-B, CO-402-COLD-B-DD, CO-402-COLD-DD, CO-402W, LVC-12, LVC-15, LVC-15D, LVC-21, LVC-21B, LVC-21C, LVC-21D, LVC-21W, MF-21		

para lavadora

			
1			
código	698504	referencia	12026769 DO00V21001
descripción	bastidor FAGOR parte central para lavadora		

pomos

pomos personalizados para fabricantes

<p>FAGOR</p> 			
1			
código	112293	referencia	12024300 Z203069
descripción	pomo interruptor marca cero ø 39mm eje ø 6x4,6mm parte plana abajo negro		
Para modelos:	ECO-160D, ECO-160I, ECO-200D, ECO-200HD, ECO-200HI, ECO-200I, ECO-280D, ECO-280I, ECO-370D, ECO-370I, ECO-460D, ECO-460I, ECO-550D, ECO-550I, FI-160AR, FI-160D, FI-160I, FI-200AR, FI-200D, FI-200HD, FI-200HI, FI-200I, FI-200WL, FI-200WR, FI-280D, FI-280I, FI-30, FI-30AR, FI-30AR+DD, FI-30B, FI-30B-BT-UK, FI-30-UK, FI-370D, FI-370I, FI-460D, FI-460I, FI-48, FI-48AR, FI-48B, FI-48B-BT-UK, FI-48C, FI-48D, FI-48HY-CLINIC, FI-48W, FI-550D, FI-550I, FI-60DD, FI-64, FI-64AR, FI-64B...(Otros modelos se puede ver en la tienda web)		

			
1			
código	112296	referencia	12024309 Z214902
descripción	pomo interruptor marca cero ø 39mm eje ø 6x4,6mm parte plana abajo negro eje L 19mm		
Para modelos:	ECO-120, ECO-120B, FI-100, FI-100AR, FI-100B, FI-120, FI-120B, FI-120W, FI-30, FI-30AR, FI-30AR+DD, FI-30B, FI-30B-BT-UK, FI-30-UK, FI-48, FI-48AR, FI-48B, FI-48B-BT-UK, FI-48C, FI-48D, FI-48HY-CLINIC, FI-48W, FI-64, FI-64AR, FI-64B, FI-64B-BT-UK, FI-64C, FI-64D, FI-64HY-CLINIC, FI-64W, FI-80, FI-80AR, FI-80BBT-UK, LABP-1000, LABP-1200, LABP-800, LVC-12, LVC-15, LVC-15D, LVC-21, LVC-21B, LVC-21C, LVC-21D, LVC-21W, MF-120, MF-48, MF-64		



1

código	113003	referencia	12040072 R343043
descripción	pomo marca cero ø 39mm eje ø 6x4,6mm parte plana abajo		
Para modelos:	FE-18, FE-25, FE-4, FE-6, FE-8, FI-300B, HCV-10-11, HCV-10-21, HCV-2-10-21, HCV-5-11, HE-10-11, HE-10-21, HE-2-10-11, HE-5-11, HE-6-11, HG-10-11, HG-10-21, HG-2-10-11		



1

código	113042	referencia	12009885 Z513024000
descripción	pomo marca cero T máx°C°C ø 50mm eje ø 6x4,6mm parte plana abajo negro		
Para modelos:	ECO-160D, ECO-160I, ECO-200D, ECO-200HD, ECO-200HI, ECO-200I, ECO-2700D, ECO-2700I, ECO-280D, ECO-280I, ECO-370D, ECO-370I, ECO-4000D, ECO-4000I, ECO-460D, ECO-460I, ECO-550D, ECO-550I, ECO-6000D, ECO-6000I, FI-160AR, FI-160D, FI-160I, FI-200AR, FI-200D, FI-200HD, FI-200HI, FI-200I, FI-200WL, FI-200WR, FI-2700D, FI-2700I, FI-280D, FI-280I, FI-370D, FI-370I, FI-4000D, FI-4000I, FI-460D, FI-460I, FI-550D, FI-550I, FI-6000D, FI-6000I		



1

código	550438	referencia	12039850 Z603052
descripción	indicador de mando para pomo		
Para modelos:	FE-18, FE-25, FE-4, FE-6, FE-8, FI-300B, FI-300R, FI-650R, HCV-10-11, HCV-10-21, HCV-2-10-21, HCV-5-11, HE-10-11, HE-10-21, HE-2-10-11, HE-5-11, HE-6-11, HG-10-11, HG-10-21, HG-2-10-11, LC-10, LC-14, LC-7, LC-7A		

accesorios

juntas



1

código	691074	referencia	12024516 R663046
descripción	junta eje de interruptor		
Para modelos:	CO-350, CO-350-B, CO-350-B-DD, CO-350-COLD, CO-350-COLD-B, CO-350-COLD-B-DD, CO-350-COLD-DD, CO-350-DD, CO-400, CO-400-B, CO-400-B-DD, CO-400-COLD, CO-400-COLD-B, CO-400-COLD-B-DD, CO-400-COLD-DD, CO-400-DD, CO-400-SOFT, CO-500, CO-500B, CO-500BDD, CO-500DD, CO-501, CO-501B, CO-501BDD, CO-501DD, CO-501-SOFT, COP-503, COP-503B, COP-503BDD, COP-503DD, COP-503-SOFT, COP-504, COP-504B, COP-504BDD, COP-504DD, ECO-2700D, ECO-2700I, ECO-4000D, ECO-4000I, ECO-6000D, ECO-6000I, FI-200W, FI-2700D, FI-2700I, FI-4000D, FI-4000I, FI-6000D, FI-6000I, HCG-10-11, HCG-10-21...(Otros modelos se puede ver en la tienda web)		

manillas y volantes

manillas cónicas



1

código	111464	referencia	12021169 Z102105
descripción	manilla cónica rosca M10 ø 26mm L 42mm plástico negro		
Para modelos:	ECO-1600, ECO-2300, ECO-3000, FI-1600, FI-2300, FI-3000		

agarraderos

FAGOR



1

código	507538	referencia	12009630 12019260 Z450502
descripción	asidero L 505mm An 29mm H 35mm dist. del agujero 277mm UE 1 pzs		
Para modelos:	AD-20C-UK, AD-21C		

asas de arco



1

código	505001	referencia	12016135 U580521
descripción	asa de arco L 182mm H 42mm distancia de sujeción 170mm rosca M6 An 36mm		
Para modelos:	CG-310, CG-310G, CG7-61, CG9-51L, CG9-51LC, CG9-51R, CG9-51RC, CG9-61, CGB7-61, CPG7-05, ECO-280D, ECO-280I, ECO-370D, ECO-370I, ECO-460D, ECO-460I, ECO-550D, ECO-550I, EN9-05C, EN9-10C, FE-710, FE-720, FE9-05, FE9-05S, FE9-10, FE-920, FG-710, FG-720, FG9-05, FG9-05S, FG9-10, FG-920, FG-940, FI-280D, FI-280I, FI-370D, FI-370I, FI-460D, FI-460I, FI-550D, FI-550I, LVC-12, LVC-15, LVC-15D, LVC-21, LVC-21B, LVC-21D, LVC-21W, LVR-10, LVR-14...(Otros modelos se puede ver en la tienda web)		



código	691681	referencia	12024991 Z400540
descripción	asa de arco L 205mm distancia de sujeción 170mm ø 30mm manilla M5		
Para modelos:	CG9-51L, CG9-51LC, CG9-51R, CG9-51RC, CG9-61, CPG9-11, CPG9-05, CPG9-05NC, CPG9-05S, CPG9-05SNC, ECO-2700D, ECO-2700I, ECO-280D, ECO-280I, ECO-370D, ECO-370I, ECO-4000D, ECO-4000I, ECO-460D, ECO-460I, ECO-550D, ECO-550I, ECO-6000D, ECO-6000I, EN9-05C, EN9-10C, FE9-05, FE9-05S, FE9-05USMC, FE9-10, FG9-05, FG9-05S, FG9-10, FI-2700D, FI-2700I, FI-280D, FI-280I, FI-370D, FI-370I, FI-4000D, FI-4000I, FI-460D, FI-460I, FI-550D, FI-550I, FI-6000D, FI-6000I, MB9-05-PUERTA-DCHA, MB9-05-PUERTA-IZDA, MB9-10-PUERTA-DOBLE...(Otros modelos se puede ver en la tienda web)		

código	505316	referencia	12024005 Z200550
descripción	asa de arco L 293mm H 65mm distancia de sujeción 260mm rosca M6 An 36mm		
Para modelos:	ECO-160, ECO-160D, ECO-160I, ECO-200, ECO-200D, ECO-200H, ECO-200HD, ECO-200HI, ECO-200I, ECO-2700D, ECO-2700I, ECO-280D, ECO-280I, ECO-370D, ECO-370I, ECO-4000D, ECO-4000I, ECO-460D, ECO-460I, ECO-550D, ECO-550I, ECO-6000D, ECO-6000I, FI-100, FI-100AR, FI-100B, FI-100BBT-UK, FI-160, FI-160AR, FI-160D, FI-160I, FI-200, FI-200AR, FI-200D, FI-200H, FI-200HD, FI-200HI, FI-200I, FI-200W, FI-200WL, FI-200WR, FI-2700D, FI-2700I, FI-280D, FI-280I, FI-370D, FI-370I, FI-4000D, FI-4000I, FI-460D...(Otros modelos se puede ver en la tienda web)		

código	691679	referencia	12024557 Z400542
descripción	asa de arco L 310mm H 32mm distancia de sujeción 260mm lavavajillas desde 2007 manilla M6		
Para modelos:	ATM-031ECO, CE6-41, CG-310, CG-310G, CG6-41, CGE6-41, FI-100, FI-100AR, FI-100B, FI-100BBT-UK, FI-80, FI-80AR, FI-80BBT-UK, FI-80W, FI-E-100, LVC-12, LVC-15, LVC-15D, LVC-21, LVC-21B, LVC-21C, LVC-21D, LVC-21W		

cierres

cierre electromagnético

código	692613	referencia	12003922 12038364 12038446 12127838 12154822 13P6205160
descripción	cierre electromagnético L 220mm An 100mm H 50mm		
Para modelos:	LA-25M, LA-AC-10M, LA-AC-10MA, LA-AC-10MP, LA-AC-13M, LA-AC-13MA, LA-AC-13MP, LA-AC-18M, LA-AC-18MA, LA-AC-18MP, LA-AC-25M, LA-AC-25MA, LA-AC-25MP, LA-E-10M, LA-E-10MA, LA-E-10MP, LA-E-13M, LA-E-13MA, LA-E-13MP, LA-E-18M, LA-E-18MA, LA-E-18MP, LA-E-25M, LA-E-25MA, LA-E-25MP, LA-V-10M, LA-V-10MP, LA-V-13M, LA-V-13MP, LA-V-18M, LA-V-18MP, LA-V-25M, LA-V-25MP, LB-AC-10M, LB-E-10M, LB-V-10M, LF-13MPP, LF-18MPP, LF-8MPP, LR-AC-10M, LR-AC-10MA, LR-AC-10MP, LR-AC-13M, LR-AC-13MA, LR-AC-13MP, LR-AC-18M, LR-AC-18MA, LR-AC-18MP, LR-AC-25M, LR-AC-25MA...(Otros modelos se puede ver en la tienda web)		

cierres de pestillo espagnolette

específicas del fabricante

FAGOR

grupo 2

código	516198	referencia	12010285 Q271033 Q301033
descripción	anillo truarco E D1 ø 6mm D2 ø 12mm inox DIN 6799 espesor 0.7mm para árbol ø 7-9mm		
Para modelos:	COE-201, COE-202, COG-201, COG-202, FE-710, FE-720, FE9-05, FE9-05S, FE9-05USMC, FE9-10, FE-920, HCG-10-11, HCG-10-21, HCG-20-11, HCG-20-21, HCG-2-10-11, HCG-2-20-11, HCG-6-11, HCV-10-11, HCV-10-21, HCV-2-10-21, HCV-6-11, HE-10-11, HE-10-21, HE-2-10-11, HE-6-11, HEI-10-21, HEI-20-21, HEM-10-21, HEM-20-21, HEP-10-21, HEP-20-21, HG-10-21, HG-2-10-11, HGC-10-21, HGC-20-21, HGP-10-21, HGP-20-21, HGV-10-11, HGV-10-21, HGV-20-11, HGV-20-21, HME-10-11, HME-10-21, HME-20-11, HME-20-21, HME-2-10-11, HME-2-20-11, HME-6-11, HMG-10-11...(Otros modelos se puede ver en la tienda web)		

código	560126	referencia	12009890 Q242030
descripción	arandela dentada int.ø 5.2mm ø ext. 10mm inox DIN/ISO DIN 6798A UE 20 pzs para rosca M5		
Para modelos:	ACE-061, ACE-101, ACE-102, ACE-201, ACE-202, ACG-061, ACG-101, ACG-102, ACG-201, ACG-202, AD-120, AD-120B, AD-120BTTDD-UK, AD-120C, AD-120CW, AD-120HY, AD-15, AD-15D, AD-20C-UK, AD-21, AD-21B, AD-21BDD, AD-21C, AD-21D, AD-21DD, AD-21W, AD-45BBT, AD-48, AD-48B, AD-48BDD, AD-48C, AD-48D, AD-48DD, AD-48HY, AD-48W, AD-64, AD-64B, AD-64BBT, AD-64BDD, AD-64C, AD-64CW, AD-64D, AD-64DD, AD-64HY, AD-72, AD-72W, AD-90, AD-90BA, AD-90BBT, AD-90BDD...(Otros modelos se puede ver en la tienda web)		

			
1			
código	560123	referencia	12009872 Q262040
descripción	arandela grower int.ø 6.3mm ø ext. 11mm inox DIN127 UE 20 pzs para rosca M6		
Para modelos:	ACE-061, ACE-101, ACE-102, ACE-201, ACE-202, AD-120, AD-120B, AD-120BBTDD-UK, AD-120C, AD-120CW, AD-120HY, AD-15, AD-15D, AD-20C-UK, AD-21, AD-21B, AD-21BDD, AD-21C, AD-21D, AD-21DD, AD-21W, AD-45BBT, AD-48, AD-48B, AD-48BDD, AD-48C, AD-48D, AD-48DD, AD-48HY, AD-48W, AD-64, AD-64B, AD-64BBT, AD-64BDD, AD-64BTDD, AD-64C, AD-64CW, AD-64D, AD-64DD, AD-64HY, AD-72, AD-72W, AD-90, AD-90BA, AD-90BBT, AD-90BDD, AD-90DD, ADE-120, ADE-120B, AE-061...(Otros modelos se puede ver en la tienda web)		

			
1			
código	560068	referencia	12010213 Q032032
descripción	tornillo de cabeza plana rosca M5 rosca L 16mm inox DIN 7985/ISO 7045 UE 20 pzs soporte Phillips ø cabezal 10mm espesor cabezal 2mm		
Para modelos:	ACE-201, ACE-202, ACG-201, ACG-202, AD-120B, AD-120BBTDD-UK, AD-120C, AD-120HY, AD-15, AD-15D, AD-20C-UK, AD-21, AD-21B, AD-21BDD, AD-21C, AD-21D, AD-21DD, AD-21W, AD-90BA, AD-90BBT, AD-90BDD, ADE-120B, AE-201, AE-202, AG-201, AG-202, APE-201, APE-202, APG-201, APG-202, COE-201, COE-202, COG-201, COG-202, ECO-120B, FI-100B, FI-100BBT-UK, FI-120B, FI-120C, FI-120HY-CLINIC, FI-80BBT-UK, GA-20, GA-20D, GA-40, GA-40D, HCG-10-11, HCG-10-21, HCG-20-11, HCG-20-21, HCG-2-10-11...(Otros modelos se puede ver en la tienda web)		



			
1			
código	560132	referencia	12010194 12010284 Q162030 Q163030
descripción	tuerca hexagonal rosca M5 H 4mm EC 8 inox DIN/ISO DIN 934 / ISO 4032/8673 UE 20 pzs		
Para modelos:	ACE-061, ACE-101, ACE-102, ACE-201, ACE-202, ACG-061, ACG-101, ACG-102, ACG-201, ACG-202, AD-120, AD-120B, AD-120BBTDD-UK, AD-120C, AD-120CW, AD-120HY, AD-15, AD-15D, AD-20C-UK, AD-21, AD-21B, AD-21BDD, AD-21C, AD-21D, AD-21DD, AD-21W, AD-45BBT, AD-48, AD-48B, AD-48BDD, AD-48C, AD-48D, AD-48DD, AD-48HY, AD-48W, AD-64, AD-64B, AD-64BBT, AD-64BDD, AD-64BTDD, AD-64C, AD-64CW, AD-64D, AD-64DD, AD-64HY, AD-72, AD-72W, AD-90, AD-90BA, AD-90BBT...(Otros modelos se puede ver en la tienda web)		

			
1			
código	511212	referencia	12010255 Q162040 Q163140000
descripción	tuerca hexagonal rosca M6 H 5mm EC 10 inox DIN/ISO DIN 934 / ISO 4032/8673 UE 1 pzs		
Para modelos:	ACE-061, ACE-101, ACE-102, ACE-201, ACE-202, ACG-061, ACG-101, ACG-102, ACG-201, ACG-202, AD-120, AD-120B, AD-120BBTDD-UK, AD-120C, AD-120CW, AD-120HY, AD-15, AD-15D, AD-20C-UK, AD-21, AD-21B, AD-21BDD, AD-21C, AD-21D, AD-21DD, AD-21W, AD-45BBT, AD-48, AD-48B, AD-48BDD, AD-48C, AD-48D, AD-48DD, AD-48HY, AD-48W, AD-64, AD-64B, AD-64BBT, AD-64BDD, AD-64BTDD, AD-64C, AD-64CW, AD-64D, AD-64DD, AD-64HY, AD-72, AD-72W, AD-90, AD-90BA, AD-90BBT...(Otros modelos se puede ver en la tienda web)		

bisagras

accesorios

ejes

			
1			
código	700818	referencia	12024071 Z400516
descripción	perno de bisagra L 32mm acero inoxidable D1 ø 7.8mm D2 ø 12mm		
Para modelos:	AD-15, AD-15D, AD-20C-UK, AD-21, AD-21B, AD-21BDD, AD-21C, AD-21D, AD-21DD, AD-21W, AD-45BBT, AD-48, AD-48B, AD-48BDD, AD-48C, AD-48D, AD-48DD, AD-48HY, AD-48W, AD-64, AD-64B, AD-64BBT, AD-64BDD, AD-64BTDD, AD-64C, AD-64CW, AD-64D, AD-64DD, AD-64HY, AD-72, AD-72W, EASY-500, EASY-500B, EASY-500DD, EASY-500HP, EASY-500HPWBDD, FI-30, FI-30AR, FI-30AR+DD, FI-30B, FI-30B-BT-UK, FI-30-UK, FI-48, FI-48AR, FI-48B, FI-48B-BT-UK, FI-48C, FI-48D, FI-48HY-CLINIC, FI-48W...(Otros modelos se puede ver en la tienda web)		
repuestos para	700818		
	código	505005	referencia
			12022324 Z400514
	bisagra de puerta bisagra/ izquierda pos. de montaje izquierdo		

elementos extraíbles

ruedas de rodadura

			
1			
código	501343	referencia	12034280 12038133 GQ500214 SPQ510708P
descripción	rueda de rodadura rodilloø 75mm A1 12mm anchura total 25mm A 75mm B 12mm C 25mm plástico superficie fricción goma		
Para modelos:	SE-7		

accesorios

			
1			
código	505252	referencia	12037139 12038096 SPQ56461 SPQ56461P
descripción	eje para rueda de rodadura		



pies para aparatos y tapas terminales

pies para aparatos

con placa de sujeción



código	701100	referencia	12009104 12033566 6007050017 X260151
descripción	pie de aparato tubo ø 64mm dimensiones de la placa 82x82mm dist. del agujero 65x65mm H 135-200mm inox medida 2 1/2" UE 1 pzs		
Para modelos:	AC-120, AC-180, ACE-061, ACE-101, ACE-102, ACG-061, ACG-101, ACG-102, AD-120, AD-120B, AD-120BBTDD-UK, AD-120C, AD-120CW, AD-120HY, AD-125, AD-125HRS, AD-125-SOFT, AD-72, AD-72W, AD-90, AD-90BA, AD-90BBT, AD-90BDD, AD-90DD, ADAEP-1602, ADAEP-801, ADAFN-1602, ADAFN-801, ADAFP-1602, ADAFP-801, ADE-120, ADE-120B, ADMCN-135, ADMCN-180, ADMCN-225, ADMCP-135, ADMCP-180, ADMCP-225, ADMFN-135, ADMFN-180, ADMFN-225, ADMFP-135, ADMFP-135-GR, ADMFP-135HD, ADMFP-135HH, ADMFP-135PC, ADMFP-180, ADMFP-180-GR, ADMFP-180HDD, ADMFP-180HHD...(Otros modelos se puede ver en la tienda web)		

pies fijos

plástico/inox



código	700110	referencia	12024301 R675610
descripción	pie de aparato tipo de tubo 40x40 grosor de la pared 1-1,2mm H 23-60mm plástico/inox UE 1 pzs		
Para modelos:	ECO-120, ECO-120B, ECO-160, ECO-1600, ECO-160D, ECO-160I, ECO-200, ECO-200D, ECO-200H, ECO-200HD, ECO-200HI, ECO-200I, ECO-2300, ECO-280D, ECO-280I, ECO-3000, ECO-370D, ECO-370I, ECO-460D, ECO-460I, ECO-550D, ECO-550I, FI-100, FI-100AR, FI-100B, FI-120, FI-120B, FI-120W, FI-160, FI-1600, FI-160D, FI-160I, FI-200, FI-200D, FI-200H, FI-200HD, FI-200HI, FI-200I, FI-200W, FI-2300, FI-280D, FI-280I, FI-3000, FI-370D, FI-370I, FI-460D, FI-460I, FI-550D, FI-550I, FI-80...(Otros modelos se puede ver en la tienda web)		

pies enroscables



código	510115	referencia	12024163 6003010275 Z200107
descripción	pie de aparato rosca M10 rosca L 40mm ø 30mm H 10mm UE 1 pzs		
Para modelos:	AD-15, AD-15D, AD-20C-UK, AD-21, AD-21B, AD-21BDD, AD-21C, AD-21D, AD-21DD, AD-21W, AD-45BBT, AD-48, AD-48B, AD-48BDD, AD-48C, AD-48D, AD-48DD, AD-48HY, AD-48W, AD-505, AD-505-SOFT, AD-64, AD-64B, AD-64BBT, AD-64BDD, AD-64BTDD, AD-64C, AD-64CW, AD-64D, AD-64DD, AD-64HY, BG6-05I, BG7-05, BG7-05I, BG7-10, BG7-10I, BG9-05, BG9-05AD, BG9-05I, BG9-05PF, BG9-05PI, BG9-05PLUS-I, BG9-10, BG9-10AD, BG9-10I, BG9-10PF, BG9-10PI, BG9-10PLUS-I, BME6-05, BME7-05...(Otros modelos se puede ver en la tienda web)		

cestos

cestos de lavado

cestos de plástico redondos



código	970648	referencia	12020206 Z605304
descripción	cesta para vajillas diversas ø ext. 350mm H 120mm soporte ø 280mm tipo de maneta de malla gruesa		
Para modelos:	LVR-10, LVR-14, LVR-14D		

cestos de plástico octogonal

cestas de lavado



código	971136	referencia	12024550 Z415320
descripción	cesta para vajillas diversas L 352mm An 352mm H 105mm		
Para modelos:	AD-15, AD-15D, CO-350, CO-350-B, CO-350-B-DD, CO-350-COLD, CO-350-COLD-B, CO-350-COLD-B-DD, CO-350-COLD-DD, CO-350-DD, CO-352-COLD, CO-352-COLD-B, CO-352-COLD-B-DD, CO-352-COLD-DD, LVC-12, LVC-15, LVC-15D		



1

código	976000	referencia	12025069 Z44532
descripción	cesta para vajillas diversas L 395mm An 395mm H 145mm		
Para modelos:	AD-20C-UK, AD-21, AD-21B, AD-21BDD, AD-21C, AD-21D, AD-21DD, AD-21W, CO-400, CO-400-B, CO-400-B-DD, CO-400-COLD, CO-400-COLD-B, CO-400-COLD-B-DD, CO-400-COLD-DD, CO-400-DD, CO-400-SOFT, CO-402-COLD, CO-402-COLD-B, CO-402-COLD-B-DD, CO-402-COLD-DD, CO-402W, LVC-21, LVC-21B, LVC-21C, LVC-21D, LVC-21W		

accesorios

cuterteros



1

código	976010	referencia	12025242
descripción	complemento para cubiertos Lmm Anmm ø 95mm H 105mm plástico		
Para modelos:	AD-15, AD-15D, AD-20C-UK, AD-21, AD-21B, AD-21BDD, AD-21C, AD-21D, AD-21DD, AD-21W, CO-350, CO-350-B, CO-350-B-DD, CO-350-COLD, CO-350-COLD-B, CO-350-COLD-B-DD, CO-350-COLD-DD, CO-350-DD, CO-352-COLD, CO-352-COLD-B, CO-352-COLD-B-DD, CO-352-COLD-DD, CO-400, CO-400-B, CO-400-B-DD, CO-400-COLD, CO-400-COLD-B, CO-400-COLD-B-DD, CO-400-COLD-DD, CO-400-DD, CO-400-SOFT, CO-402-COLD, CO-402-COLD-B, CO-402-COLD-B-DD, CO-402-COLD-DD, CO-402W, LVC-12, LVC-15, LVC-15D, LVC-21, LVC-21B, LVC-21C, LVC-21D, LVC-21W		

esquinas deslizantes



1

código	970001	referencia	12039794 Z855303
descripción	esquina deslizante espesor de hilo 5mm L 120mm An 120mm H 12mm L-Form		
Para modelos:	FI-300B, LVC-12, LVC-15		

soportes para cestos



1

código	691910	referencia	12000014 12000235 12012770 12038455 12Z7103250 12Z7103770 Z710311
descripción	soporte para cestos L 540mm An 630mm apto para FI 80 - 120 acero inoxidable		
Para modelos:	ECO-120, ECO-120B, FI-100, FI-100AR, FI-100B, FI-100BBT-UK, FI-120, FI-120AR+DD, FI-120B, FI-120C, FI-120HY-CLINIC, FI-120W, FI-80, FI-80AR, FI-80BBT-UK, FI-80W, FI-E-100, MF-120		

complementos para platos



1

código	976005	referencia	12024286 Z605302
descripción	complemento para platos L 335mm An 195mm H 105mm platos 10 recubierto de plástico		
Para modelos:	AD-15, AD-15D, CO-350, CO-350-B, CO-350-B-DD, CO-350-COLD, CO-350-COLD-B, CO-350-COLD-B-DD, CO-350-COLD-DD, CO-350-DD, CO-352-COLD, CO-352-COLD-B, CO-352-COLD-B-DD, CO-352-COLD-DD, LVC-12, LVC-15, LVC-15D, LVR-14, LVR-14D		



1

código	976014	referencia	12025030 Z625302
descripción	complemento para platos L 370mm An 195mm H 105mm platos 11 recubierto de plástico		
Para modelos:	AD-20C-UK, AD-21, AD-21B, AD-21BDD, AD-21C, AD-21D, AD-21DD, AD-21W, CO-400, CO-400-B, CO-400-B-DD, CO-400-COLD, CO-400-COLD-B, CO-400-COLD-B-DD, CO-400-COLD-DD, CO-400-DD, CO-400-SOFT, CO-402-COLD, CO-402-COLD-B, CO-402-COLD-B-DD, CO-402-COLD-DD, CO-402W, LVC-21, LVC-21B, LVC-21C, LVC-21D, LVC-21W, LVR-20, LVR-20B, LVR-20D, MF-21		

rejillas y rieles guía

rieles guía y soportos

específico del fabricante



1

código	691887	referencia	12021988 Z712509
descripción	soporte de bandeja L 28mm An 20mm H 15mm inox		
Para modelos:	ECO-120, ECO-120B, FI-100, FI-100AR, FI-100B, FI-120, FI-120B, FI-120W, FI-80, FI-80W, MF-120		



juntas

juntas tóricas

EPDM

ø1,78mm

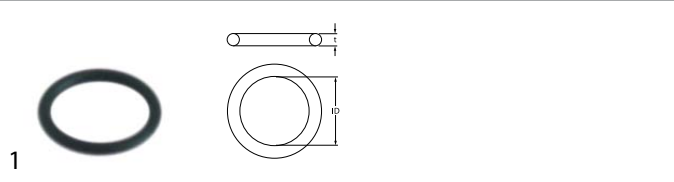

código	529545	referencia	12009911 Q307056
---------------	--------	-------------------	---------------------

descripción junta tórica EPDM espesor 1.78mm int.ø 10.82mm UE 1 pzs

Para modelos: AD-15, AD-15D, AD-20C-UK, AD-21, AD-21B, AD-21BDD, AD-21C, AD-21D, AD-21DD, AD-21W, CO-350, CO-350-B, CO-350-B-DD, CO-350-COLD, CO-350-COLD-B, CO-350-COLD-B-DD, CO-350-COLD-DD, CO-350-DD, CO-352-COLD, CO-352-COLD-B, CO-352-COLD-B-DD, CO-352-COLD-DD, CO-400, CO-400-B, CO-400-B-DD, CO-400-COLD, CO-400-COLD-B, CO-400-COLD-B-DD, CO-400-COLD-DD, CO-400-SOFT, CO-402-COLD, CO-402-COLD-B, CO-402-COLD-B-DD, CO-402-COLD-DD, CO-402W, LVC-12, LVC-15, LVC-15D, LVC-21, LVC-21B, LVC-21C, LVC-21D, LVC-21W, MF-21

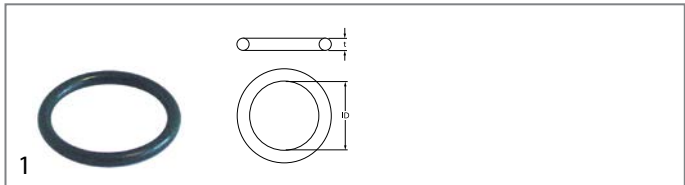

código	505073	referencia	12010282 Q307041
---------------	--------	-------------------	---------------------

descripción junta tórica EPDM espesor 2.62mm int.ø 20.63mm UE 1 pzs

Para modelos: AD-15, AD-15D, AD-20C-UK, AD-21, AD-21B, AD-21BDD, AD-21C, AD-21D, AD-21W, CG-1002, CG-1502, CG-2000, CG-2000-2P, CG-2002, CG-2002P, CG9-11, CG9-11AD, CG9-11PLUS, CG9-31PLUS-D, CG9-31PLUS-I, CG9-41, CG9-41AD, CG9-41AD-H, CG9-41H, CG9-41PLUS, CG9-41PLUS-H, CG9-51L, CG9-51LC, CG9-51R, CG9-51RC, CG9-61, CG9-61AD, CG9-61AD-H, CG9-61H, CG9-61OP, CG9-61PLUS, CG9-61PLUS-H, CG9-82, CG9-82AD, CG9-82PLUS, CGF9-121D, CGF9-121D-AD, CGF9-121I, CGF9-121PLUS-D, CGF9-121PLUS-I, FF-35, FI-5420, FI-7630, FTG9-11L, FTG9-11L+R...(Otros modelos se puede ver en la tienda web)

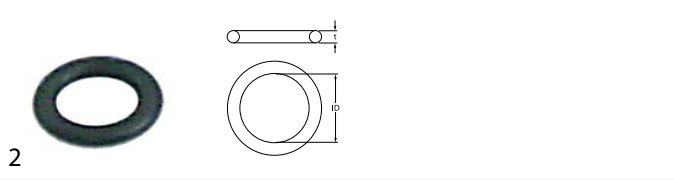

código	505045	referencia	12009912 Q307036
---------------	--------	-------------------	---------------------

descripción junta tórica EPDM espesor 1.78mm int.ø 5.28mm UE 1 pzs

Para modelos: AD-15, AD-15D, AD-90, AD-90BA, AD-90BDD, AD-90DD, COG-202, EASY-500, EASY-500B, EASY-500DD, EASY-500HP, EASY-500HPWBDD, FI-30, FI-30AR, FI-30AR+DD, FI-30B, FI-30B-BT-UK, FI-30-UK, FI-48, FI-48AR, FI-48B, FI-48B-BT-UK, FI-48C, FI-48D, FI-48HY-CLINIC, FI-48W, FI-60DD, FI-80, FI-80AR, FI-80W, FI-E-100, HGC-20-21, HGP-10-21, HGP-20-21, HGV-20-21, LABP-800, LF-13MPP, LF-18MPP, LF-25MPP, LF-8MPP, LVC-12, LVC-15, LVC-15D, LVC-21, LVC-21B, LVC-21D, LVC-21W, LVR-10, LVR-14, LVR-20...(Otros modelos se puede ver en la tienda web)

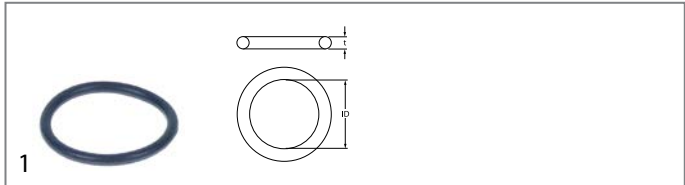

código	532499	referencia	12010230 Q307062
---------------	--------	-------------------	---------------------

descripción junta tórica EPDM espesor 2.62mm int.ø 23.47mm UE 1 pzs

Para modelos: ECO-160, ECO-160D, ECO-160I, ECO-200, ECO-200D, ECO-200H, ECO-200HD, ECO-200HI, ECO-200I, FI-160, FI-160AR, FI-160D, FI-160I, FI-200, FI-200AR, FI-200D, FI-200H, FI-200HD, FI-200HI, FI-200I, FI-200W, FI-200WL, FI-200WR

ø2,62mm

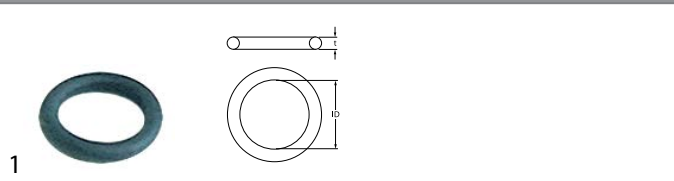

código	529412	referencia	12009873 Q307003
---------------	--------	-------------------	---------------------

descripción junta tórica EPDM espesor 2.62mm int.ø 10.78mm UE 1 pzs

Para modelos: AD-120, AD-120B, AD-120BBTDD-UK, AD-120C, AD-120CW, AD-120HY, AD-15, AD-15D, AD-20C-UK, AD-21, AD-21B, AD-21BDD, AD-21C, AD-21D, AD-21DD, AD-21W, AD-45BBT, AD-48, AD-48B, AD-48BDD, AD-48C, AD-48D, AD-48DD, AD-48HY, AD-48W, AD-64, AD-64B, AD-64BBT, AD-64BDD, AD-64BTDD, AD-64C, AD-64CW, AD-64D, AD-64DD, AD-64HY, AD-72, AD-72W, AD-90, AD-90BA, AD-90BBT, AD-90BDD, AD-90DD, ADE-120, ADE-120B, CO-350, CO-350-B, CO-350-B-DD, CO-350-COLD, CO-350-COLD-B, CO-350-COLD-B-DD...(Otros modelos se puede ver en la tienda web)

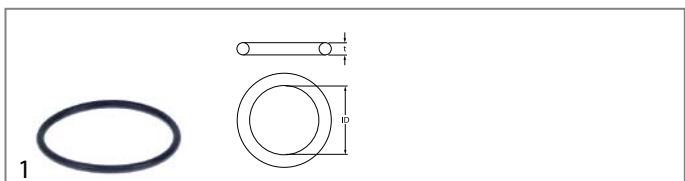

código	532494	referencia	12010165 Q307051 Q307061
---------------	--------	-------------------	--------------------------------

descripción junta tórica EPDM espesor 2.62mm int.ø 36.14mm UE 1 pzs

Para modelos: AD-120, AD-120B, AD-120BBTDD-UK, AD-120C, AD-120CW, AD-120HY, AD-45BBT, AD-48, AD-48B, AD-48BDD, AD-48C, AD-48D, AD-48DD, AD-48HY, AD-48W, AD-64, AD-64B, AD-64BBT, AD-64BDD, AD-64BTDD, AD-64C, AD-64CW, AD-64D, AD-64DD, AD-64HY, AD-72, AD-72W, AD-90, AD-90BA, AD-90BBT, AD-90BDD, AD-90DD, ADE-120, ADE-120B, EASY-500, EASY-500B, EASY-500DD, EASY-500HP, ECO-120, ECO-120B, ECO-160, ECO-160D, ECO-160I, ECO-200, ECO-200D, ECO-200H, ECO-200HD, ECO-200HI, ECO-200I, ECO-2700D...(Otros modelos se puede ver en la tienda web)

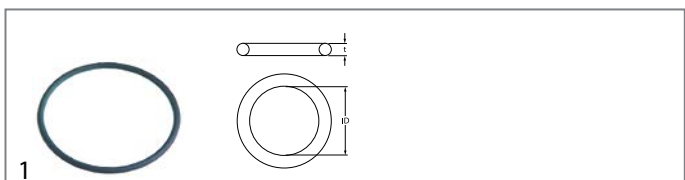

código	532546	referencia	12010184 Q307064
---------------	--------	-------------------	---------------------

descripción junta tórica EPDM espesor 2.62mm int.ø 52.07mm UE 1 pzs

Para modelos: ECO-280D, ECO-280I, ECO-370D, ECO-370I, ECO-460D, ECO-460I, ECO-550D, ECO-550I, FI-280D, FI-280I, FI-370D, FI-370I, FI-460D, FI-460I, FI-550D, FI-550I

componentes mecánicos y accesorios aparatos



ø3,00mm

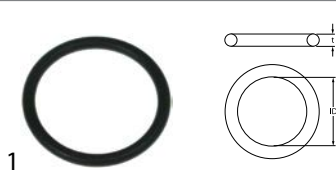

código	532548	referencia	12010176 Q307068
descripción	junta tórica EPDM espesor 3mm int.ø 27mm UE 1 pzs		
Para modelos:	ECO-2700D, ECO-2700I, ECO-280D, ECO-280I, ECO-370D, ECO-370I, ECO-4000D, ECO-4000I, ECO-460D, ECO-460I, ECO-550D, ECO-550I, ECO-6000D, ECO-6000I, FI-2700D, FI-2700I, FI-280D, FI-280I, FI-370D, FI-370I, FI-4000D, FI-4000I, FI-460D, FI-460I, FI-550D, FI-550I, FI-6000D, FI-6000I		

ø3,53mm



código	532102	referencia	12010234 Q307063
descripción	junta tórica EPDM espesor 3.53mm int.ø 12.29mm UE 10 pzs		
Para modelos:	ECO-160, ECO-160D, ECO-160I, ECO-200, ECO-200D, ECO-200H, ECO-200HD, ECO-200HI, ECO-200I, ECO-2700D, ECO-2700I, ECO-280D, ECO-280I, ECO-370D, ECO-370I, ECO-4000D, ECO-4000I, ECO-460D, ECO-460I, ECO-550D, ECO-550I, ECO-6000D, ECO-6000I, FI-160, FI-160AR, FI-160D, FI-160I, FI-200, FI-200AR, FI-200D, FI-200H, FI-200HD, FI-200HI, FI-200I, FI-200W, FI-200WL, FI-200WR, FI-2700D, FI-2700I, FI-280D, FI-280I, FI-370D, FI-370I, FI-4000D, FI-4000I, FI-460D, FI-460I, FI-550D, FI-550I, FI-6000D...(Otros modelos se puede ver en la tienda web)		

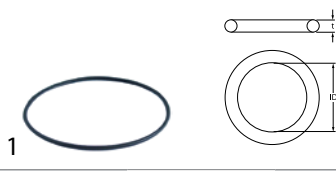

código	532151	referencia	12021011 Z201084
descripción	junta tórica EPDM espesor 3.53mm int.ø 120.2mm UE 10 pzs		
Para modelos:	ECO-120, ECO-120B, FI-100, FI-100AR, FI-100B, FI-120, FI-120B, FI-120W, MF-120		



código	532103	referencia	12049214
descripción	junta tórica EPDM espesor 3.53mm int.ø 13.87mm UE 10 pzs		
Para modelos:	AD-125, AD-125HRS, AD-125-SOFT, CO-110, CO-110B, CO-110BDD, CO-110DD, CO-112, CO-112B, CO-112BDD, CO-112DD, CO-170, CO-170B, CO-170BDD, CO-170DD, CO-170HRS, CO-170HRSDD, CO-170HRS-SOFT, CO-170-SOFT, CO-172, CO-172B, CO-172BDD, CO-172DD, COP-173, COP-173B, COP-173BDD, COP-173DD, COP-173HRS, COP-173HRSDD, COP-173-SOFT, COP-174, COP-174B, COP-174BDD, COP-174DD, COP-174HRS, COP-174HRSDD		

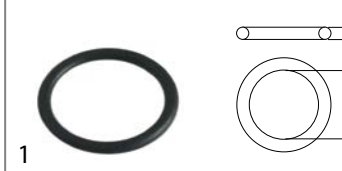

código	505152	referencia	12009666 Q307000
descripción	junta tórica EPDM espesor 3.53mm int.ø 29mm UE 1 pzs		
Para modelos:	ECO-1200, ECO-1600, ECO-2300, ECO-3000, FE-18, FE-25, FI-1200, FI-1600, FI-2300, FI-3000, FI-300B, FI-300R, FI-650R, FI-900		



código	512511	referencia	12115850
descripción	junta tórica EPDM espesor 3.53mm int.ø 32mm UE 10 pzs		
Para modelos:	CO-500, CO-500B, CO-500BDD, CO-500DD, CO-501, CO-501B, CO-501BDD, CO-501DD, CO-501-SOFT, CO-502B, CO-502BDD, CO-502DD, CO-502W, COP-503, COP-503B, COP-503BDD, COP-503DD, COP-503-SOFT, COP-504, COP-504B, COP-504BDD, COP-504DD, COP-504W		

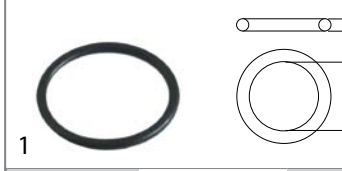

código	506015	referencia	12024031 Z471109
descripción	junta tórica EPDM espesor 3.53mm int.ø 39.69mm UE 1 pzs		
Para modelos:	AD-15D, AD-21D, AD-48D, AD-64D, CO-400-SOFT, FI-48, FI-48AR, FI-48B, FI-48B-BT-UK, FI-48C, FI-48D, FI-48HY-CLINIC, FI-48W, FI-64, FI-64AR, FI-64B, FI-64B-BT-UK, FI-64C, FI-64D, FI-64HY-CLINIC, FI-64W, LVC-15D, LVC-21D		



código	505180	referencia	12010118 Q307057
descripción	junta tórica EPDM espesor 3.53mm int.ø 47.22mm UE 1 pzs		
Para modelos:	AD-120, AD-120B, AD-120BBD-UK, AD-120C, AD-120CW, AD-120HY, AD-90, AD-90BA, AD-90BBT, AD-90BDD, AD-90DD, ADE-120, ADE-120B, ECO-120, ECO-120B, ECO-160, ECO-160D, ECO-160I, ECO-200, ECO-200D, ECO-200H, ECO-200HD, ECO-200HI, ECO-200I, ECO-280D, ECO-280I, ECO-370D, ECO-370I, ECO-460D, ECO-460I, ECO-550D, ECO-550I, FI-100, FI-100AR, FI-100B, FI-100BBT-UK, FI-120, FI-120AR+DD, FI-120B, FI-120C, FI-120HY-CLINIC, FI-120W, FI-160, FI-160D, FI-160I, FI-200, FI-200D, FI-200H, FI-200HD, FI-200HI...(Otros modelos se puede ver en la tienda web)		



código	532498	referencia	12010256 Q307048
descripción	junta tórica EPDM espesor 3.53mm int.ø 9.12mm UE 1 pzs		
Para modelos:	AD-120, AD-120B, AD-120BBTDD-UK, AD-120C, AD-120CW, AD-120HY, AD-45BBT, AD-48, AD-48B, AD-48BDD, AD-48C, AD-48D, AD-48DD, AD-48HY, AD-48W, AD-64, AD-64B, AD-64BBT, AD-64BDD, AD-64BTDD, AD-64C, AD-64CW, AD-64D, AD-64DD, AD-64HY, AD-72, AD-72W, AD-90, AD-90BA, AD-90BBT, AD-90BDD, AD-90DD, ADE-120, ADE-120B, EASY-500, EASY-500B, EASY-500DD, EASY-500HP, EASY-500HPWBDD, ECO-120, ECO-1200, ECO-120B, ECO-160, ECO-1600, ECO-160D, ECO-160I, ECO-200, ECO-200D, ECO-200H, ECO-200HD... (Otros modelos se puede ver en la tienda web)		

código	510409	referencia	12010040 Q307044
descripción	junta tórica EPDM espesor 5.34mm int.ø 56.52mm UE 1 pzs		
Para modelos:	ECO-160, ECO-1600, ECO-160D, ECO-160I, ECO-200, ECO-200D, ECO-200H, ECO-200HD, ECO-200HI, ECO-200I, ECO-2300, ECO-2700D, ECO-2700I, ECO-280D, ECO-280I, ECO-3000, ECO-370D, ECO-370I, ECO-4000D, ECO-4000I, ECO-460D, ECO-460I, ECO-550D, ECO-550I, ECO-6000D, ECO-6000I, FI-160, FI-1600, FI-160AR, FI-160D, FI-160I, FI-200, FI-200AR, FI-200D, FI-200H, FI-200HD, FI-200HI, FI-200I, FI-200W, FI-200WL, FI-200WR, FI-2300, FI-2700D, FI-2700I, FI-280D, FI-280I, FI-3000, FI-370D, FI-370I, FI-4000D... (Otros modelos se puede ver en la tienda web)		

<p>ø5,34mm</p>			
código	505092	referencia	12010062 12016701 Q307053 S312113
descripción	junta tórica EPDM espesor 5.34mm int.ø 43.82mm UE 1 pzs		
Para modelos:	AD-15, AD-15D, AD-20C-UK, AD-21, AD-21B, AD-21BDD, AD-21C, AD-21D, AD-21DD, AD-21W, LVC-12, LVC-15, LVC-15D, LVC-21, LVC-21B, LVC-21C, LVC-21D, LVC-21W, LVR-10, LVR-14, LVR-14D, LVR-20, LVR-20B, LVR-20D, MF-21		

código	691033	referencia	12010051 Q307035
descripción	junta tórica EPDM espesor 5.34mm int.ø 62.87mm UE 1 pzs		
Para modelos:	AD-120, AD-120B, AD-120BBTDD-UK, AD-120C, AD-120HY, AD-45BBT, AD-48, AD-48B, AD-48BDD, AD-48C, AD-48D, AD-48DD, AD-48HY, AD-48W, AD-64, AD-64B, AD-64BBT, AD-64BDD, AD-64BTDD, AD-64C, AD-64CW, AD-64D, AD-64DD, AD-64HY, AD-72, AD-72W, AD-90, AD-90BA, AD-90BBT, AD-90BDD, AD-90DD, CO-110, CO-110B, CO-110BDD, CO-110DD, CO-112, CO-112B, CO-112BDD, CO-112DD, CO-142W, CO-142WDD, CO-170, CO-170B, CO-170BDD, CO-170DD, CO-170HRS, CO-170HRSDD, CO-170HRS-SOFT, CO-170-SOFT... (Otros modelos se puede ver en la tienda web)		

código	510408	referencia	12039760 eu456002 Q307020
descripción	junta tórica EPDM espesor 5.34mm int.ø 47mm UE 1 pzs		
Para modelos:	ECO-1200, FI-1200, FI-300B, FI-300R, FI-650R, FI-900		

código	505178	referencia	12009976 Q307049
descripción	junta tórica EPDM espesor 5.34mm int.ø 85.09mm UE 1 pzs		
Para modelos:	AD-45BBT, AD-48, AD-48B, AD-48BDD, AD-48C, AD-48D, AD-48DD, AD-48HY, AD-48W, AD-64, AD-64B, AD-64BBT, AD-64BDD, AD-64BTDD, AD-64C, AD-64CW, AD-64D, AD-64DD, AD-64HY, AD-72, AD-72W, EASY-500, EASY-500B, EASY-500DD, EASY-500HP, EASY-500HPWBDD, FI-30, FI-30AR, FI-30AR+DD, FI-30B, FI-30B-BT-UK, FI-30-UK, FI-48, FI-48AR, FI-48B, FI-48B-BT-UK, FI-48C, FI-48D, FI-48HY-CLINIC, FI-48W, FI-50, FI-60DD, FI-64, FI-64AR, FI-64B, FI-64B-BT-UK, FI-64C, FI-64D, FI-64HY-CLINIC, FI-64W... (Otros modelos se puede ver en la tienda web)		

código	505175	referencia	12010079 Q307052
descripción	junta tórica EPDM espesor 5.34mm int.ø 50.16mm UE 1 pzs		
Para modelos:	AD-15, AD-15D, AD-20C-UK, AD-21, AD-21B, AD-21BDD, AD-21C, AD-21D, AD-21DD, AD-21W, AD-45BBT, AD-48, AD-48B, AD-48BDD, AD-48C, AD-48D, AD-48DD, AD-48HY, AD-48W, AD-64, AD-64B, AD-64BBT, AD-64BDD, AD-64BTDD, AD-64C, AD-64CW, AD-64D, AD-64DD, AD-64HY, AD-72, AD-72W, CO-350, CO-350-B, CO-350-B-DD, CO-350-COLD, CO-350-COLD-B, CO-350-COLD-B-DD, CO-350-COLD-DD, CO-350-DD, CO-352-COLD, CO-352-COLD-B, CO-352-COLD-B-DD, CO-352-COLD-DD, CO-400, CO-400-B, CO-400-B-DD, CO-400-COLD, CO-400-COLD-B, CO-400-COLD-B-DD, CO-400-COLD-DD... (Otros modelos se puede ver en la tienda web)		

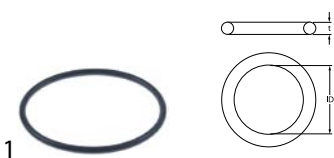

código	532639	referencia	12009995 Q307045
descripción	junta tórica EPDM espesor 5.34mm int.ø 94.62mm UE 1 pzs		
Para modelos:	ECO-160, ECO-1600, ECO-160D, ECO-160I, ECO-200, ECO-200D, ECO-200H, ECO-200HD, ECO-200HI, ECO-200I, ECO-2300, ECO-280D, ECO-280I, ECO-3000, ECO-370D, ECO-370I, ECO-460D, ECO-460I, ECO-550D, ECO-550I, FI-160, FI-1600, FI-160AR, FI-160D, FI-160I, FI-200, FI-200AR, FI-200D, FI-200H, FI-200HD, FI-200HI, FI-200I, FI-200W, FI-200WL, FI-200WR, FI-2300, FI-280D, FI-280I, FI-3000, FI-370D, FI-370I, FI-460D, FI-460I, FI-550D, FI-550I		

anillos de junta

juntas de fibra



código	505246	referencia	12016868 Z953097
descripción	junta plana FIBER ø ext. 17mm int.ø 13.5mm espesor 1.5mm UE 1 pzs		
Para modelos:	GA-20, GA-20D, GA-40, GA-40D		



código	510153	referencia	12010206 Q306050
descripción	junta plana fibra ø ext. 12mm int.ø 6.2mm espesor 1.5mm UE 1 pzs		
Para modelos:	AD-120, AD-120B, AD-120C, AD-120CW, AD-45BBT, AD-48, AD-48B, AD-48C, AD-48D, AD-48DD, AD-48HY, AD-48W, AD-64, AD-64B, AD-64BBT, AD-64BTDD, AD-64C, AD-64CW, AD-64D, AD-64DD, AD-64HY, AD-72, AD-72W, AD-90, AD-90BA, AD-90BBT, AD-90BDD, AD-90DD, ADE-120, ADE-120B, ECO-120, ECO-120B, ECO-160, ECO-160D, ECO-160I, ECO-200, ECO-200D, ECO-200H, ECO-200HD, ECO-200HI, ECO-200I, FI-100, FI-100AR, FI-100B, FI-100BBT-UK, FI-120, FI-120AR+DD, FI-120B, FI-120C, FI-120HY-CLINIC...(Otros modelos se puede ver en la tienda web)		



código	507332	referencia	12010260 Q306024
descripción	junta plana fibra ø ext. 18mm int.ø 12mm espesor 2mm UE 1 pzs		
Para modelos:	AD-120, AD-120B, AD-120BBTDD-UK, AD-120C, AD-120CW, AD-120HY, AD-45BBT, AD-48, AD-48B, AD-48BDD, AD-48C, AD-48D, AD-48DD, AD-48HY, AD-48W, AD-64, AD-64B, AD-64BBT, AD-64BDD, AD-64BTDD, AD-64C, AD-64CW, AD-64D, AD-64DD, AD-64HY, AD-72, AD-72W, AD-90, AD-90BA, AD-90BBT, AD-90BDD, AD-90DD, ADE-120B, BME7-05, BME7-10, BME9-05, BME9-05AD, BME9-05PLUS, BME9-05V-T, BME9-10, BME9-10AD, BME9-10PLUS, BME9-10V-T, BMG7-10, BMG-9045, BMG9-05, BMG9-05V-T, BMG9-10, BMG9-10V-T...(Otros modelos se puede ver en la tienda web)		



código	510152	referencia	12010203 Q306038
descripción	junta plana fibra ø ext. 31mm int.ø 21mm espesor 1.5mm UE 1 pzs		
Para modelos:	ADE-120, ADE-120B, BME7-05, BME7-10, BME9-05, BME9-10, BMG7-10, BMG-9045, BMG9-05, BMG9-10, CPE9-05, CPE9-05S, CPG7-05, CPG9-05, CPG9-05NC, CPG9-05S, CPG9-05SNC, ECO-120, ECO-1200, ECO-120B, ECO-160, ECO-1600, ECO-160D, ECO-160I, ECO-200, ECO-200D, ECO-200H, ECO-200HD, ECO-200HI, ECO-200I, ECO-2300, ECO-2700D, ECO-2700I, ECO-280D, ECO-280I, ECO-3000, ECO-370D, ECO-370I, ECO-4000D, ECO-4000I, ECO-460D, ECO-460I, ECO-550D, ECO-550I, ECO-6000D, ECO-6000I, GA-20, GA-20D, GA-40, GA-40D...(Otros modelos se puede ver en la tienda web)		



código	510406	referencia	12035981 ICR09387
descripción	junta plana fibra ø ext. 60mm int.ø 48mm espesor 3mm para rosca 1½" UE 1 pzs		

juntas de goma





código	505249	referencia	12009936 Q307011
descripción	junta ø ext. 56mm int.ø 39mm espesor 1mm UE 1 pzs		
Para modelos:	ECO-1600, ECO-2300, ECO-280D, ECO-280I, ECO-3000, ECO-370D, ECO-370I, ECO-460D, ECO-460I, ECO-550D, ECO-550I, FI-1600, FI-2300, FI-280D, FI-280I, FI-3000, FI-370D, FI-370I, FI-460D, FI-460I, FI-550D, FI-550I		





código	505199	referencia	12010191 Q307031
descripción	junta plana goma ø ext. 24mm int.ø 14mm espesor 3mm UE 1 pzs		
Para modelos:	AD-45BBT, AD-48B, AD-48BDD, AD-48C, AD-48HY, AD-48W, AD-64B, AD-64BBT, AD-64BDD, AD-64C, AD-64CW, AD-64HY, BME7-05, BME7-10, BMG7-10, ECO-120, ECO-1200, FI-100, FI-100AR, FI-100B, FI-100BBT-UK, FI-120, FI-1200, FI-120B, FI-120W, FI-200W, FI-30, FI-300B, FI-300R, FI-30B, FI-30B-BT-UK, FI-48, FI-48AR, FI-48B, FI-48B-BT-UK, FI-48C, FI-48HY-CLINIC, FI-48W, FI-50, FI-64, FI-64AR, FI-64B, FI-64B-BT-UK, FI-64C, FI-64HY-CLINIC, FI-64W, FI-650R, FI-72, FI-80, FI-80BBT-UK...(Otros modelos se puede ver en la tienda web)		





			
1			
código	900909	referencia	12018710 Z401905
descripción	junta plana goma ø ext. 31mm int.ø 18mm espesor 2mm UE 1 pzs		
Para modelos:	LVR-10, LVR-14, LVR-20, LVR-20B		

			
1			
código	515018	referencia	12009947 Q307032
descripción	junta plana goma ø ext. 32mm int.ø 21mm espesor 3mm UE 1 pzs		
Para modelos:	AD-120, AD-120B, AD-120BBTDD-UK, AD-120C, AD-120CW, AD-120HY, AD-90, AD-90BA, AD-90BBT, AD-90BDD, AD-90DD, ADE-120, ADE-120B, BME7-05, BME7-10, BME9-05, BME9-05AD, BME9-05PLUS, BME9-05V-T, BME9-10, BME9-10AD, BME9-10PLUS, BME9-10V-T, BMG7-10, BMG9-05, BMG9-05V-T, BMG9-10, BMG9-10V-T, CO-142W, CO-142WDD, COP-174W, COP-174WHR, ECO-120, ECO-1200, ECO-120B, ECO-160, ECO-1600, ECO-160D, ECO-160I, ECO-200, ECO-200D, ECO-200H, ECO-200HD, ECO-200HI, ECO-200I, ECO-2300, ECO-2700D, ECO-2700I, ECO-280D, ECO-280I...(Otros modelos se puede ver en la tienda web)		

			
1			
código	510154	referencia	12010053 Q307029
descripción	junta plana goma ø ext. 33mm int.ø 26mm espesor 2mm UE 1 pzs		
Para modelos:	ECO-120, FE-18, FE-25, FG-1-40, FG-2-80, FI-100, FI-120, FI-120W, FI-30, FI-48, FI-48B, FI-48W, FI-50, FI-64, FI-64B, FI-64W, FI-72, LVC-21W, MF-21, MF-48, MF-64, MG-9150BM		

			
1			
código	505161	referencia	12010028 Q307027
descripción	junta plana goma ø ext. 45mm int.ø 35mm espesor 2mm UE 1 pzs		
Para modelos:	BMG-9045, ECO-1200, ECO-1600, ECO-2300, ECO-2700D, ECO-2700I, ECO-280D, ECO-280I, ECO-3000, ECO-370D, ECO-370I, ECO-4000D, ECO-4000I, ECO-460D, ECO-460I, ECO-550D, ECO-550I, ECO-6000D, ECO-6000I, FI-1200, FI-1600, FI-2300, FI-2700D, FI-2700I, FI-280D, FI-280I, FI-3000, FI-300B, FI-300R, FI-370D, FI-370I, FI-4000D, FI-4000I, FI-460D, FI-460I, FI-550D, FI-550I, FI-6000D, FI-6000I, FI-650R, FI-900		

			
1			
código	501302	referencia	12023554 R675007
descripción	junta plana goma ø ext. 57mm int.ø 30mm espesor 2mm UE 1 pzs		
Para modelos:	AD-45BBT, AD-48HY, AD-64BBT, AD-64BTDD, AD-64HY, EA-SY-500HPWBDD, FI-30B-BT-UK, FI-48B-BT-UK, FI-48HY-CLINIC, FI-64B-BT-UK, FI-64HY-CLINIC, HEI-10-11, HEI-20-11, HEI-6-11, HEM-10-11, HEM-20-11, HEM-6-11, HEP-10-11, HEP-20-11, HEP-6-11, HME-10-11, HME-10-21, HME-20-11, HME-20-21, HME-2-10-11, HME-2-20-11, HME-6-11, HMI-10-11, HMI-10-11UL, HMI-10-21, HMI-10-21UL, HMI-2-10-11, HMI-6-11, HMI-6-11UL, HMM-10-11, HMM-10-11UL, HMM-10-21, HMM-10-21UL, HMM-20-11, HMM-20-11UL, HMM-20-21, HMM-20-21UL, HMM-2-10-11, HMM-2-20-11, HMM-40-11-USMC, HMM-6-11, HMM-6-11UL, HMP-10-11, HMP-10-21, HMP-20-11...(Otros modelos se puede ver en la tienda web)		

			
1			
código	505224	referencia	12009960 Q307058
descripción	junta plana goma ø ext. 60mm int.ø 44mm espesor 2mm UE 1 pzs		
Para modelos:	AD-120, AD-120B, AD-120BBTDD-UK, AD-120C, AD-120CW, AD-120HY, AD-90, AD-90BA, AD-90BBT, AD-90BDD, AD-90DD, ADE-120, ADE-120B, ECO-120, ECO-120B, ECO-160, ECO-160D, ECO-160I, ECO-200, ECO-200D, ECO-200H, ECO-200HD, ECO-200HI, ECO-200I, ECO-370D, ECO-370I, ECO-550D, ECO-550I, FI-100, FI-100AR, FI-100B, FI-100BBT-UK, FI-120, FI-120AR+DD, FI-120B, FI-120C, FI-120HY-CLINIC, FI-120W, FI-160, FI-160AR, FI-160D, FI-160I, FI-200, FI-200AR, FI-200D, FI-200H, FI-200HD, FI-200HI, FI-200I, FI-200W...(Otros modelos se puede ver en la tienda web)		

			
1			
código	505223	referencia	12009939 Q307009
descripción	junta plana goma ø ext. 70mm int.ø 48mm espesor 1.5mm UE 1 pzs		
Para modelos:	BMG-9045, ECO-1200, ECO-1600, ECO-2300, ECO-2700D, ECO-2700I, ECO-280D, ECO-280I, ECO-3000, ECO-370D, ECO-370I, ECO-4000D, ECO-4000I, ECO-460D, ECO-460I, ECO-550D, ECO-550I, ECO-6000D, ECO-6000I, FI-1200, FI-1600, FI-2300, FI-2700D, FI-2700I, FI-280D, FI-280I, FI-3000, FI-300B, FI-300R, FI-370D, FI-370I, FI-4000D, FI-4000I, FI-460D, FI-460I, FI-550D, FI-550I, FI-6000D, FI-6000I, FI-650R, FI-900		

			
1			
código	505247	referencia	12039795 Q307024
descripción	junta plana goma ø ext. 72mm int.ø 54mm espesor 2mm UE 1 pzs		
Para modelos:	ECO-280D, ECO-280I, ECO-370D, ECO-370I, ECO-460D, ECO-460I, ECO-550D, ECO-550I, FI-280D, FI-280I, FI-300B, FI-300R, FI-370D, FI-370I, FI-460D, FI-460I, FI-550D, FI-550I, FI-650R		

			
1			
código	505194	referencia	12009937 Q307059
descripción	junta plana goma ø ext. 72mm int.ø 57mm espesor 2mm UE 1 pzs		
Para modelos:	AD-120, AD-120B, AD-120BBTDD-UK, AD-120C, AD-120CW, AD-120HY, AD-90, AD-90BA, AD-90BBT, AD-90BDD, AD-90DD, ADE-120, ADE-120B, ECO-120, ECO-120B, ECO-160, ECO-160D, ECO-160I, ECO-200, ECO-200D, ECO-200H, ECO-200HD, ECO-200HI, ECO-200I, ECO-2700D, ECO-2700I, ECO-280D, ECO-280I, ECO-370D, ECO-370I, ECO-4000D, ECO-4000I, ECO-460D, ECO-460I, ECO-550D, ECO-550I, ECO-6000D, ECO-6000I, FI-100, FI-100AR, FI-100B, FI-100BBT-UK, FI-120, FI-120AR+DD, FI-120B, FI-120C, FI-120HY-CLINIC, FI-120W, FI-160, FI-160AR...(Otros modelos se puede ver en la tienda web)		

componentes mecánicos y accesorios aparatos



			
1			
código	510832	referencia	12023571 Z310902
descripción	junta plana goma ø ext. 92mm int.ø 66mm espesor 2mm UE 1 pzs núm. Ref. 200906/33456		
Para modelos:	ECO-2700D, ECO-2700I, ECO-280D, ECO-280I, ECO-370D, ECO-370I, ECO-4000D, ECO-4000I, ECO-460D, ECO-460I, ECO-550D, ECO-550I, ECO-6000D, ECO-6000I, FI-2700D, FI-2700I, FI-280D, FI-280I, FI-370D, FI-370I, FI-4000D, FI-4000I, FI-460D, FI-460I, FI-550D, FI-550I, FI-6000D, FI-6000I		

			
1			
código	505245	referencia	12039712 Q307038
descripción	junta plana ø ext. 77mm int.ø 48mm espesor 1.5mm UE 1 pzs		
Para modelos:	ECO-1200, FI-1200, FI-900		

juntas de plástico

			
1			
código	510212	referencia	12019069 Q308008
descripción	junta plana plástico ø ext. 12mm int.ø 7.3mm espesor 2mm UE 1 pzs		
Para modelos:	FI-300B, FI-300R, FI-650R		

juntas de PTFE

			
1			
código	505226	referencia	12018644 Q308009
descripción	anillo deslizante PTFE ø ext. 19mm int.ø 7.5mm espesor 2mm UE 1 pzs		
Para modelos:	FI-300B, FI-300R, FI-650R		

			
1			
código	505225	referencia	12009922 Q308012
descripción	anillo deslizante PTFE ø ext. 30mm int.ø 10mm espesor 3mm para bisagra de campana UE 1 pzs		
Para modelos:	AD-120, AD-120B, AD-120BBTDD-UK, AD-120C, AD-120CW, AD-120HY, AD-90, AD-90BA, AD-90BBT, AD-90BDD, AD-90DD, ADE-120, ADE-120B, ECO-120, ECO-120B, FI-100, FI-100AR, FI-100B, FI-100BBT-UK, FI-120, FI-120AR+DD, FI-120B, FI-120C, FI-120HY-CLINIC, FI-120W, FI-80, FI-80AR, FI-80BBT-UK, FI-80W, FI-E-100, LABP-1000, LABP-1200, LABP-800, MF-120		

juntas de gomaespuma

			
1			
código	505250	referencia	12021459 Z680532
descripción	junta de gomaespuma An 20mm espesor 5mm UE 720mm		
Para modelos:	ECO-1200, FI-1200, FI-900		

			
1			
código	505237	referencia	12025277 Z400309
descripción	junta de gomaespuma An 8mm espesor 2mm autoadhesivo UE 450mm		
Para modelos:	AD-15, AD-15D, LVC-12, LVC-15, LVC-15D, LVR-10, LVR-14, LVR-14D		

			
1			
código	505264	referencia	12024174 Z200313
descripción	junta de gomaespuma An 9mm espesor 2.5mm autoadhesivo UE 625mm		
Para modelos:	AD-45BBT, AD-48, AD-48B, AD-48BDD, AD-48C, AD-48D, AD-48DD, AD-48HY, AD-48W, AD-64, AD-64B, AD-64BBT, AD-64BDD, AD-64BTDD, AD-64C, AD-64CW, AD-64D, AD-64DD, AD-64HY, AD-72, AD-72W, EASY-500, EASY-500B, EASY-500DD, EASY-500HP, EASY-500HPWBDD, FI-30, FI-30AR, FI-30AR+DD, FI-30B, FI-30B-BT-UK, FI-30-UK, FI-48, FI-48AR, FI-48B, FI-48B-BT-UK, FI-48C, FI-48D, FI-48HY-CLINIC, FI-48W, FI-50, FI-60DD, FI-64, FI-64AR, FI-64B, FI-64B-BT-UK, FI-64C, FI-64D, FI-64HY-CLINIC, FI-64W...(Otros modelos se puede ver en la tienda web)		

juntas de árbol

juntas de árbol

			
1			
código	698001	referencia	12025169 Z105016
descripción	junta radial int.ø 20mm ø ext. 35mm espesor 7mm		
Para modelos:	ECO-160, ECO-1600, ECO-160D, ECO-160I, ECO-200, ECO-200D, ECO-200H, ECO-200HD, ECO-200HI, ECO-200I, ECO-2300, ECO-280D, ECO-280I, ECO-3000, ECO-370D, ECO-370I, ECO-460D, ECO-460I, ECO-550D, ECO-550I, FI-160, FI-1600, FI-160AR, FI-160D, FI-160I, FI-200, FI-200AR, FI-200D, FI-200H, FI-200HD, FI-200HI, FI-200I, FI-200W, FI-200WL, FI-200WR, FI-2300, FI-280D, FI-280I, FI-3000, FI-370D, FI-370I, FI-460D, FI-460I, FI-550D, FI-550I		



juntas especiales

juntas de puerta para lavavajillas



1

código	505250	referencia	12021459 Z680532
descripción	junta de gomaespuma An 20mm espesor 5mm UE 720mm		
Para modelos:	ECO-1200, FI-1200, FI-900		



1

código	505237	referencia	12025277 Z400309
descripción	junta de gomaespuma An 8mm espesor 2mm autoadhesivo UE 450mm		
Para modelos:	AD-15, AD-15D, LVC-12, LVC-15, LVC-15D, LVR-10, LVR-14, LVR-14D		



1

código	505264	referencia	12024174 Z200313
descripción	junta de gomaespuma An 9mm espesor 2.5mm autoadhesivo UE 625mm		
Para modelos:	AD-45BBT, AD-48, AD-48B, AD-48BDD, AD-48C, AD-48D, AD-48DD, AD-48HY, AD-48W, AD-64, AD-64B, AD-64BBT, AD-64BDD, AD-64BTDD, AD-64C, AD-64CW, AD-64D, AD-64DD, AD-64HY, AD-72, AD-72W, EASY-500, EASY-500B, EASY-500DD, EASY-500HP, EASY-500HPWBDD, FI-30, FI-30AR, FI-30AR+DD, FI-30B, FI-30B-BT-UK, FI-30-UK, FI-48, FI-48AR, FI-48B, FI-48B-BT-UK, FI-48C, FI-48D, FI-48HY-CLINIC, FI-48W, FI-50, FI-60DD, FI-64, FI-64AR, FI-64B, FI-64B-BT-UK, FI-64C, FI-64D, FI-64HY-CLINIC, FI-64W...(Otros modelos se puede ver en la tienda web)		



1

código	518215	referencia	12024374
descripción	junta de puerta L 590mm An 26mm H 26mm silicona FAGOR apto para lavavajillas		
Para modelos:	AD-45BBT, AD-48, AD-48B, AD-48BDD, AD-48C, AD-48D, AD-48DD, AD-48HY, AD-48W, AD-64, AD-64B, AD-64BBT, AD-64BDD, AD-64BTDD, AD-64C, AD-64CW, AD-64D, AD-64DD, AD-64HY, AD-72, AD-72W, EASY-500, EASY-500B, EASY-500DD, EASY-500HP, EASY-500HPWBDD, FI-30, FI-30AR, FI-30AR+DD, FI-30B, FI-30B-BT-UK, FI-30-UK, FI-48, FI-48AR, FI-48B, FI-48B-BT-UK, FI-48C, FI-48D, FI-48HY-CLINIC, FI-48W, FI-60DD, FI-64, FI-64AR, FI-64B, FI-64B-BT-UK, FI-64C, FI-64D, FI-64HY-CLINIC, FI-64W, FI-72...(Otros modelos se puede ver en la tienda web)		

otros



1

código	505078	referencia	12024556 Z200907
descripción	junta altura exterior 23.5mm para cubeta ø ext. 225mm int.ø 200mm		
Para modelos:	AD-45BBT, AD-48, AD-48B, AD-48BDD, AD-48C, AD-48D, AD-48DD, AD-48HY, AD-48W, AD-64, AD-64B, AD-64BBT, AD-64BDD, AD-64BTDD, AD-64C, AD-64CW, AD-64D, AD-64DD, AD-64HY, AD-72, AD-72W, EASY-500, EASY-500B, EASY-500DD, EASY-500HP, FI-30, FI-30AR, FI-30AR+DD, FI-30B, FI-30B-BT-UK, FI-30-UK, FI-48, FI-48AR, FI-48B, FI-48B-BT-UK, FI-48C, FI-48D, FI-48HY-CLINIC, FI-48W, FI-50, FI-60DD, FI-64, FI-64AR, FI-64B, FI-64B-BT-UK, FI-64C, FI-64D, FI-64HY-CLINIC, FI-64W, FI-72...(Otros modelos se puede ver en la tienda web)		



1

código	505077	referencia	12024113 Z400902
descripción	junta altura exterior 23mm para cubeta		
Para modelos:	AD-15, AD-15D, AD-20C-UK, AD-21, AD-21B, AD-21BDD, AD-21C, AD-21D, AD-21DD, AD-21W, CO-350, CO-350-B, CO-350-B-DD, CO-350-COLD, CO-350-COLD-B, CO-350-COLD-B-DD, CO-350-COLD-DD, CO-350-DD, CO-352-COLD, CO-352-COLD-B, CO-352-COLD-B-DD, CO-352-COLD-DD, CO-400, CO-400-B, CO-400-B-DD, CO-400-COLD, CO-400-COLD-B, CO-400-COLD-B-DD, CO-400-COLD-DD, CO-400-DD, CO-400-SOFT, CO-402-COLD, CO-402-COLD-B, CO-402-COLD-B-DD, CO-402-COLD-DD, CO-402W, LVC-12, LVC-15, LVC-15D, LVC-21, LVC-21B, LVC-21C, LVC-21D, LVC-21W, LVR-10, LVR-14, LVR-14D, LVR-20, LVR-20B, LVR-20D...(Otros modelos se puede ver en la tienda web)		



código	511992	referencia	12023517 Z710547
descripción	junta para FAGOR para mecanismos de capota L 100mm An 86mm espesor 2mm dist. del agujero 30/45mm		
Para modelos:	AD-120, AD-120B, AD-120BBTDD-UK, AD-120C, AD-120CW, AD-120HY, AD-90, AD-90BA, AD-90BBT, AD-90BDD, AD-90DD, ADE-120, ADE-120B, ECO-120, ECO-120B, FI-100, FI-100AR, FI-100B, FI-100BBT-UK, FI-120, FI-120AR+DD, FI-120B, FI-120C, FI-120HY-CLINIC, FI-120W, FI-80, FI-80AR, FI-80BBT-UK, FI-80W, FI-E-100, LABP-1000, LABP-1200, LABP-800, MF-120		

juntas de termostato



código	505093	referencia	12024049 N503017
descripción	junta para termostato ø ext. 35mm int.ø 24mm espesor 7mm núm. Ref. N503017		
Para modelos:	AD-120, AD-120B, AD-120BBTDD-UK, AD-120C, AD-120CW, AD-120HY, AD-15, AD-15D, AD-20C-UK, AD-21, AD-21B, AD-21BDD, AD-21C, AD-21D, AD-21DD, AD-21W, AD-45BBT, AD-48, AD-48B, AD-48BDD, AD-48C, AD-48D, AD-48DD, AD-48HY, AD-48W, AD-64, AD-64B, AD-64BBT, AD-64BDD, AD-64BTDD, AD-64C, AD-64CW, AD-64D, AD-64DD, AD-64HY, AD-72, AD-72W, AD-90, AD-90BA, AD-90BBT, AD-90BDD, AD-90DD, ADE-120, ADE-120B, BME7-05, BME7-10, BME9-05, BME9-10, EASY-500, EASY-500B...(Otros modelos se puede ver en la tienda web)		

juntas patra brazos de lavado



código	505167	referencia	12023533 Z400703
descripción	junta D1 ø 68mm D2 ø 35mm espesor 3.5mm con 4 orificios roscados núm. Ref. Z400703 para FAGOR		
Para modelos:	AD-15, AD-15D, AD-20C-UK, AD-21, AD-21B, AD-21BDD, AD-21C, AD-21D, AD-21DD, AD-21W, CO-350, CO-350-B, CO-350-B-DD, CO-350-COLD, CO-350-COLD-B, CO-350-COLD-B-DD, CO-350-COLD-DD, CO-350-DD, CO-352-COLD, CO-352-COLD-B, CO-352-COLD-B-DD, CO-352-COLD-DD, CO-400, CO-400-B, CO-400-B-DD, CO-400-COLD, CO-400-COLD-B, CO-400-COLD-B-DD, CO-400-COLD-DD, CO-400-DD, CO-400-SOFT, CO-402-COLD, CO-402-COLD-B, CO-402-COLD-B-DD, CO-402-COLD-DD, CO-402W, LVC-12, LVC-15, LVC-15D, LVC-21, LVC-21B, LVC-21C, LVC-21D, LVC-21W, LVR-10, LVR-14, LVR-14D, LVR-20, LVR-20B, LVR-20D...(Otros modelos se puede ver en la tienda web)		



código	505179	referencia	12024227 Z710714
descripción	junta D1 ø 82.5mm D2 ø 44mm espesor 2.5mm con 4 orificios roscados soporte brazo de lavado núm. Ref. Z710714 para FAGOR		
Para modelos:	AD-120, AD-120B, AD-120BBTDD-UK, AD-120C, AD-120CW, AD-120HY, AD-90, AD-90BA, AD-90BBT, AD-90BDD, AD-90DD, ADE-120, ADE-120B, ECO-120, ECO-120B, ECO-160, ECO-160D, ECO-160I, ECO-200, ECO-200D, ECO-200H, ECO-200HD, ECO-200HI, ECO-200I, FI-100, FI-100AR, FI-100B, FI-100BBT-UK, FI-120, FI-120AR+DD, FI-120B, FI-120C, FI-120HY-CLINIC, FI-120W, FI-160, FI-160D, FI-160I, FI-200, FI-200D, FI-200H, FI-200HD, FI-200HI, FI-200I, FI-200W, FI-80, FI-80AR, FI-80BBT-UK, FI-80W, FI-E-100, LABP-1000...(Otros modelos se puede ver en la tienda web)		

técnica de accionamiento y rodamientos de bolas

rodamientos de bolas

cojinetes a bolas 2RS



código	523551	referencia	12025150 Z105017
descripción	rodamiento de bolas radial tipo 6003-2RS árbol ø 17mm ø ext. 35mm An 10mm con arandelas de junta cojinete ranurado DIN 625-1		
Para modelos:	ECO-160, ECO-1600, ECO-160D, ECO-160I, ECO-200, ECO-200D, ECO-200H, ECO-200HD, ECO-200HI, ECO-200I, ECO-2300, ECO-280D, ECO-280I, ECO-3000, ECO-370D, ECO-370I, ECO-460D, ECO-460I, ECO-550D, ECO-550I, FI-160, FI-1600, FI-160AR, FI-160D, FI-160I, FI-200, FI-200AR, FI-200D, FI-200H, FI-200HD, FI-200HI, FI-200I, FI-200W, FI-200WL, FI-200WR, FI-2300, FI-280D, FI-280I, FI-3000, FI-370D, FI-370I, FI-460D, FI-460I, FI-550D, FI-550I		



código	505011	referencia	12024032 Z710541
descripción	rodamiento de bolas radial tipo 6200-2RS árbol ø 10mm ø ext. 30mm An 9mm DIN 625-1		
Para modelos:	AD-120, AD-120B, AD-120BBTDD-UK, AD-120C, AD-120CW, AD-120HY, AD-90, AD-90BA, AD-90BBT, AD-90BDD, AD-90DD, ADE-120, ADE-120B, ECO-120, ECO-120B, FI-100, FI-100AR, FI-100B, FI-100BBT-UK, FI-120, FI-120AR+DD, FI-120B, FI-120C, FI-120HY-CLINIC, FI-120W, FI-80, FI-80AR, FI-80BBT-UK, FI-80W, FI-E-100, LABP-1000, LABP-1200, LABP-800, MF-120		



otros



código	523010	referencia	12038332 1300000084
descripción	rodamiento de bolas juego		
Para modelos:	LA-AC-13M, LA-AC-13MA, LA-AC-13MP, LA-E-13M, LA-E-13MA, LA-E-13MP, LA-V-13M, LA-V-13MP, LF-13MPP, LR-AC-13M, LR-AC-13MA, LR-AC-13MP, LR-AC-18M, LR-AC-18MA, LR-AC-18MP, LR-E-13M, LR-E-13MA, LR-E-13MP, LR-E-18M, LR-E-18MA, LR-E-18MP, LR-V-13M, LR-V-13MP, LR-V-18M, LR-V-18MP		

cadena

cadena de rodillos 08B-1 simple



código	505339	referencia	12025097 Z275008
descripción	cadena de rodillos DIN/ISO 08 B-1 división 1/2" / 12,7mm eslabones 28 anchura interior 7.75mm rodilloø 8.51mm		
Para modelos:	ECO-160, ECO-160D, ECO-160I, ECO-200, ECO-200D, ECO-200H, ECO-200HD, ECO-200HI, ECO-200I, ECO-2700D, ECO-2700I, ECO-280D, ECO-280I, ECO-370D, ECO-370I, ECO-4000D, ECO-4000I, ECO-460D, ECO-460I, ECO-550D, ECO-550I, ECO-6000D, ECO-6000I, FI-160, FI-160AR, FI-160D, FI-160I, FI-200, FI-200AR, FI-200D, FI-200H, FI-200HD, FI-200HI, FI-200I, FI-200W, FI-200WL, FI-200WR, FI-2700D, FI-2700I, FI-280D, FI-280I, FI-370D, FI-370I, FI-4000D, FI-4000I, FI-460D, FI-460I, FI-550D, FI-550I, FI-6000D... (Otros modelos se puede ver en la tienda web)		

elementos de unión



código	693276	referencia	12023767 Z105012
descripción	elemento de empalme simple DIN/ISO 08 B-1 división 1/2" eslabones 1 L 23mm anchura interior 11.8mm rodilloø 4.3mm metal		
Para modelos:	ECO-160, ECO-160D, ECO-160I, ECO-200, ECO-200D, ECO-200H, ECO-200HD, ECO-200HI, ECO-200I, ECO-2300, ECO-2700D, ECO-2700I, ECO-280D, ECO-280I, ECO-3000, ECO-370D, ECO-370I, ECO-4000D, ECO-4000I, ECO-460D, ECO-460I, ECO-550D, ECO-550I, ECO-6000D, ECO-6000I, FI-160, FI-160AR, FI-160D, FI-160I, FI-200, FI-200AR, FI-200D, FI-200H, FI-200HD, FI-200HI, FI-200I, FI-200W, FI-200WL, FI-200WR, FI-2300, FI-2700D, FI-2700I, FI-280D, FI-280I, FI-3000, FI-370D, FI-370I, FI-4000D... (Otros modelos se puede ver en la tienda web)		

muelles

muelles de torsión



código	692159	referencia	12024390 Z271203
descripción	resorte de torsión ø 10.3mm L2 20mm espesor de hilo 1.4mm L1 2mm L3 33mm UE 1 pzs		
Para modelos:	ECO-160, ECO-160D, ECO-160I, ECO-200, ECO-200D, ECO-200H, ECO-200HD, ECO-200HI, ECO-200I, ECO-280D, ECO-280I, ECO-370D, ECO-370I, ECO-460D, ECO-460I, ECO-550D, ECO-550I, FI-160, FI-160AR, FI-160D, FI-160I, FI-200, FI-200AR, FI-200D, FI-200H, FI-200HD, FI-200HI, FI-200I, FI-200W, FI-200WL, FI-200WR, FI-280D, FI-280I, FI-370D, FI-370I, FI-460D, FI-460I, FI-550D, FI-550I		

resortes de compresión



código	505138	referencia	12040429 Z600605
descripción	resorte de compresión		
Para modelos:	FI-300B, FI-300R, FI-650R, FTG7-05, FTG7-10, FTG9-05L, FTG9-05R, FTG9-10L, FTG9-10L+R, FTG9-10R, FTGC9-05, FTGC9-10, LC-10, LC-14, LC-7, LC-7A		



código	691008	referencia	12025252 Z700603
descripción	resorte de compresión ø 10mm L 28mm espesor de hilo 0.9mm		
Para modelos:	BG9-05PLUS-I, BG9-10PLUS-I, CE-15, CE-9, FE-710, FE-720, FE9-05, FE9-05S, FE9-05USMC, FE9-10, FI-300B, FI-300R, FI-650R, FTG9-05PLUS-CL, FTG9-05PLUS-CR, FTG9-05PLUS-L, FTG9-05PLUS-LV, FTG9-05PLUS-R, FTG9-05PLUS-RV, FTG9-10PLUS-CL, FTG9-10PLUS-CLR, FTG9-10PLUS-CR, FTG9-10PLUS-L, FTG9-10PLUS-LR, FTG9-10PLUS-LRV, FTG9-10PLUS-LV, FTG9-10PLUS-R, FTG9-10PLUS-RV, HCG-10-11, HCG-10-21, HCG-20-11, HCG-2-10-11, HCG-6-11, HME-10-11, HME-10-21, HME-20-11, HME-2-10-11, HME-6-11, HMG-10-11, HMG-10-11UL, HMG-10-21, HMG-10-21UL, HMG-20-11, HMG-2-10-11, HMG-6-11, HMI-10-11, HMI-10-11UL, HMI-10-21, HMI-10-21UL... (Otros modelos se puede ver en la tienda web)		

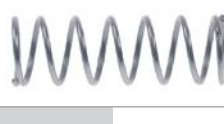

código	696553	referencia	12017801 Z883001
descripción	resorte de compresión ø 7.5mm L 23mm espesor de hilo 0.7mm		
Para modelos:	ECO-280D, ECO-280I, ECO-370D, ECO-370I, ECO-460D, ECO-460I, ECO-550D, ECO-550I, FI-280D, FI-280I, FI-370D, FI-370I, FI-460D, FI-460I, FI-550D, FI-550I, HEI-10-11, HEI-20-11, HEI-6-11, HEM-10-11, HEM-20-11, HEM-6-11, HEP-10-11, HEP-20-11, HEP-6-11, HME-10-11, HME-10-21, HME-20-11, HME-2-10-11, HME-2-20-11, HME-6-11, HMI-10-11, HMI-10-11UL, HMI-10-21, HMI-10-21UL, HMI-2-10-11, HMI-6-11, HMI-6-11UL, HMM-10-11, HMM-10-11UL, HMM-10-21, HMM-10-21UL, HMM-20-11, HMM-20-11UL, HMM-20-21UL, HMM-2-10-11, HMM-2-20-11, HMM-40-11-USMC... (Otros modelos se puede ver en la tienda web)		

componentes mecánicos y accesorios aparatos

resortes enrollados

resortes enrollados



código	501430	referencia	12024877 Z310511
descripción	resorte enrollado An 40mm int.ø 33mm longitud de lengüeta 49mm distancia de sujeción 10mm		
Para modelos:	ECO-280D, ECO-280I, ECO-370D, ECO-370I, ECO-460D, ECO-460I, ECO-550D, ECO-550I, FI-280D, FI-280I, FI-370D, FI-370I, FI-460D, FI-460I, FI-550D, FI-550I		

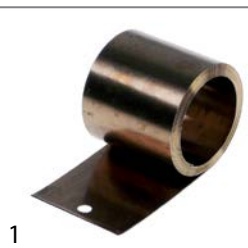

código	519451	referencia	12024689 Z270513
descripción	resorte enrollado An 40mm int.ø 35mm longitud de lengüeta 50mm		
Para modelos:	ECO-160, ECO-160D, ECO-160I, ECO-200, ECO-200D, ECO-200H, ECO-200HD, ECO-200HI, ECO-200I, ECO-2700D, ECO-2700I, ECO-280D, ECO-280I, ECO-370D, ECO-370I, ECO-4000D, ECO-4000I, ECO-460D, ECO-460I, ECO-550D, ECO-550I, ECO-6000D, ECO-6000I, FI-160, FI-160AR, FI-160D, FI-160I, FI-160I, FI-200, FI-200AR, FI-200D, FI-200H, FI-200HD, FI-200HI, FI-200I, FI-200W, FI-200WL, FI-200WR, FI-2700D, FI-2700I, FI-280D, FI-280I, FI-370D, FI-370I, FI-4000D, FI-4000I, FI-460D, FI-460I, FI-550D, FI-550I, FI-6000D... (Otros modelos se puede ver en la tienda web)		

accesorios

soportes



código	517431	referencia	12011392 Z270515
descripción	soporte para resorte enrollado ømm L 105mm An 44mm H 20mm		
Para modelos:	ECO-160, ECO-160D, ECO-160I, ECO-200, ECO-200D, ECO-200H, ECO-200HD, ECO-200HI, ECO-200I, FI-160, FI-160AR, FI-160D, FI-160I, FI-200, FI-200AR, FI-200D, FI-200H, FI-200HD, FI-200HI, FI-200I, FI-200W, FI-200WL, FI-200WR		

otros



código	504387	referencia	12024391 Z271204
descripción	resorte derecho para sistema de transporte alojamiento del ejemm ø 10.5mm L 36mm Anmm Hmm espesor de hilo 1.4mm		
Para modelos:	ECO-160, ECO-160D, ECO-160I, ECO-200, ECO-200D, ECO-200H, ECO-200HD, ECO-200HI, ECO-200I, ECO-280D, ECO-280I, ECO-370D, ECO-370I, ECO-460D, ECO-460I, ECO-550D, ECO-550I, FI-160, FI-160AR, FI-160D, FI-160I, FI-200, FI-200AR, FI-200D, FI-200H, FI-200HD, FI-200HI, FI-200I, FI-200W, FI-200WL, FI-200WR, FI-280D, FI-280I, FI-370D, FI-370I, FI-460D, FI-460I, FI-550D, FI-550I		

resortes de tracción



código	505009	referencia	12024948 Z710528
descripción	muelle de tracción ø 35mm longitud total 420mm espesor de hilo 5mm		
Para modelos:	AD-120, AD-120B, AD-120BBTDD-UK, AD-90, AD-90BA, AD-90BBT, AD-90BDD, AD-90DD, ADE-120, ADE-120B, ECO-120, ECO-120B, FI-100, FI-100AR, FI-100B, FI-100BBT-UK, FI-120, FI-120AR+DD, FI-120B, FI-120C, FI-120HY-CLINIC, FI-120W, FI-80, FI-80AR, FI-80BBT-UK, FI-80W, FI-E-100, LABP-1000, LABP-1200, LABP-800, MF-120		

manómetros



código	541596	referencia	12025146 Z102316
descripción	manómetro ø 52mm margen de presión 0 a 10bar empalme lavavajillas rosca 1/4"		
Para modelos:	ECO-160, ECO-160D, ECO-160I, ECO-200, ECO-200H, ECO-2300, ECO-3000, FI-160, FI-160D, FI-160AR, FI-160D, FI-160I, FI-200, FI-200AR, FI-200D, FI-200H, FI-200HD, FI-200HI, FI-200I, FI-2300, FI-2700D, FI-2700I, FI-280D, FI-280I, FI-3000, FI-370D, FI-370I, FI-4000D, FI-4000I, FI-460D, FI-460I, FI-550D, FI-550I, FI-6000D, FI-6000I		



código	541793	referencia	12019289 12024625 Z271125 Z718417
descripción	manómetro ø 52mm margen de presión 0-4bar rosca 1/4"		
Para modelos:	AD-120CW, CO-142W, CO-142WDD, FI-120W, FI-200W, FI-200WL, FI-200WR, FI-80W, MF-120		



dosificadores



bombas dosificadoras

GERMAC

versión empotrada

con control de frecuencia



código	361795 ¹	referencia	1200000132 19022347
descripción	dosificador GERMAC regulación de frecuencia 3l/h 230VAC detergente tubo ø 4x6mm tubo termoplástico tipo G300 3.5W 230V código 82334968 incl. kit de montaje		
Para modelos:	CO-110DD, CO-112DD, CO-142WDD, CO-170DD, CO-172DD, CO-350-COLD-DD, CO-350-DD, CO-400-COLD-DD, CO-400-DD, CO-402-COLD, CO-402-COLD-B, CO-402-COLD-B-DD, CO-402-COLD-DD, CO-402W, CO-500DD, CO-501DD, CO-502DD, CO-502W, COP-173DD, COP-174DD, COP-174W, COP-174WHR5, COP-503DD, COP-504DD, COP-504W, FI-30, FI-30AR, FI-30AR+DD, FI-30-UK, FI-48, FI-48AR, FI-48B, FI-48B-BT-UK, FI-48C, FI-48D, FI-48HY-CLINIC, FI-48W, FI-64, FI-64AR, FI-64B, FI-64B-BT-UK, FI-64C, FI-64D, FI-64HY-CLINIC, FI-64W, FI-72, FI-72AR, FI-72W		
repuestos para	361795		
	código	361142	referencia —
	kit de montaje detergente tipo de tubo 4x6mm longitud de tubo PVC 2x tubo flexible/filtro recipiente/caño de pared transparente		
	código	361268	referencia 12017199 12024224 Z209521 Z209530
	dosificador GERMAC regulación de frecuencia 3l/h 230VAC detergente tubo ø 4x6mm tubo termoplástico tipo G300 versión empotrada medidas 67x72x101mm		
	código	361467	referencia —
	tubo flexible para bomba GERMAC detergente tipo de tubo termoplástico tubo ø 6x10mm para modelo G43/G45/G53/G54/G55/G300/G305		

¹con accesorios



código	361268	referencia	12017199 12024224 Z209521 Z209530
descripción	dosificador GERMAC regulación de frecuencia 3l/h 230VAC detergente tubo ø 4x6mm tubo termoplástico tipo G300 versión empotrada medidas 67x72x101mm		
Para modelos:	FI-30, FI-48, FI-48B, FI-48W, FI-50, FI-64, FI-64B, FI-64W, FI-72, MF-48, MF-64		
repuestos para	361268		
	código	361467	referencia —
	tubo flexible para bomba GERMAC detergente tipo de tubo termoplástico tubo ø 6x10mm para modelo G43/G45/G53/G54/G55/G300/G305		





repuestos para	361268		
	código	361557	referencia —
	placa de control tipo G300/G302/G305 GERMAC		
	código	361589	referencia —
	enrollador manguera GERMAC apto para G42/43/45/53/54/55/300/302/305/705		
	código	362032	referencia —
	cubierta para GERMAC		
accesorios para	361268		
	código	361106	referencia —
	filtro de recipiente con pesa y válvula de retención inox tubo ø 4x6mm ø 21mm L 51mm válvula de retención válvula labial		
	código	520090	referencia —
	tubo flexible de PVC int.ø 4mm ø ext. 6mm L 2m grosor de la pared 1mm T máx 60°C transparente		
	código	520091	referencia —
	tubo de nylon int.ø 4mm ø ext. 6mm L 2m grosor de la pared 1mm p de trabajo 10bar p de reventamiento 50bar T máx 100°C transparente		

bombas de membrana

autoaspirantes

LARGO



código	361221	referencia	12024105 12039170 Z211109 Z651123
descripción	dosificador tipo N6 abrillantador empalme presión ø 4x6mm conector para succión ø 6x8mm LANG		
Para modelos:	AD-120, AD-120B, AD-120C, AD-120CW, AD-15, AD-15D, AD-20C-UK, AD-21, AD-21B, AD-21BDD, AD-21C, AD-21D, AD-21DD, AD-21W, AD-48, AD-48B, AD-48BDD, AD-48C, AD-48D, AD-48DD, AD-48W, AD-64, AD-64B, AD-64BDD, AD-64C, AD-64CW, AD-64D, AD-64DD, AD-72, AD-72W, AD-90, AD-90BA, AD-90BDD, AD-90DD, ADE-120, ADE-120B, ECO-120, ECO-1200, ECO-120B, FI-100, FI-100AR, FI-100B, FI-100BBT-UK, FI-120, FI-1200, FI-1200AR+DD, FI-120B, FI-120C, FI-120HY-CLINIC, FI-120W...(Otros modelos se puede ver en la tienda web)		
repuestos para	361221		
	código	361079	referencia —
	resorte para tipo N5/N6 para esfera		
	código	361080	referencia —
	junta tórica EPDM espesor 2mm int.ø 16mm UE 1 pzs		
	código	361085	referencia —
	junta tórica EPDM espesor 2mm int.ø 8mm UE 1 pzs		
	código	361309	referencia —
	esfera para tipo N5/N6		
	código	361310	referencia —
	soporte para tipo N6 guía de bola		

Continúa en la página siguiente

repuestos para	361221		
	código	361311	referencia —
	junta tórica EPDM espesor 2mm int.ø 6mm UE 1 pzs para tipo N6		
	código	361314	referencia —
	anillo de válvula para tipo N6 soporte para junta tórica		
	código	361317	referencia —
	disco de obturación para tipo N6		
	código	361886	referencia —
	válvula de retención entradamm salidamm salida ø 12.4mm L 12.7mm		
	código	505228	referencia 12024067 Z203007
	casquillo distanciador int.ø 4.5mm ø ext. 10mm L 16mm para dosificadoras		

diversos

1

código	361015	referencia	12045206
descripción	dosificador bomba de membrana abrillantador entrada 6x8mm salida 4x6mm empalme presión ø 4x6mm conector para succión ø 6x8mm		
Para modelos:	AD-120, AD-120B, AD-120C, AD-15, AD-15D, AD-20C-UK, AD-21, AD-21B, AD-21BDD, AD-21C, AD-21D, AD-21W, AD-48, AD-48B, AD-48BDD, AD-48C, AD-48D, AD-48DD, AD-48W, AD-64, AD-64B, AD-64BDD, AD-64C, AD-64CW, AD-64DD, AD-72, AD-72W, AD-90, AD-90BA, AD-90BDD, AD-90DD, ADE-120, ADE-120B, CO-110, CO-110B, CO-110BDD, CO-110DD, CO-112, CO-112B, CO-112BDD, CO-112DD, CO-142W, CO-142WDD, CO-170, CO-170B, CO-170BDD, CO-170DD, CO-170HRS, CO-170HRSDD, CO-170HRS-SOFT...(Otros modelos se puede ver en la tienda web)		
repuestos para	361015		
	código	361132	referencia —
	membrana dosificador		
	código	510298	referencia —
	válvula labial dosificador apto para DB2/DS5		

accesorios
filtros de recipientes

1

código	361062	referencia	12011355 Z601153
descripción	filtro de recipiente tubo ø 4mm		
Para modelos:	AD-125, AD-125HRS, AD-125-SOFT, AD-505, CO-110DD, CO-112DD, CO-142WDD, CO-170DD, CO-172DD, COP-173, COP-173B, COP-173BDD, COP-173DD, COP-173HRS, COP-173HRSDD, COP-173-SOFT, COP-174, COP-174B, COP-174BDD, COP-174DD, COP-174HRS, COP-174HRSDD, COP-174W, COP-174WHRS, COP-503, COP-503B, COP-503BDD, COP-503DD, COP-503-SOFT, COP-504, COP-504B, COP-504BDD, COP-504DD, COP-504W, ECO-120, ECO-1200, ECO-120B, FI-100, FI-100AR, FI-100B, FI-120, FI-1200, FI-120B, FI-120W, FI-30, FI-300B, FI-300R, FI-48, FI-48B, FI-48W...(Otros modelos se puede ver en la tienda web)		

pesas para filtros

1

código	505197	referencia	12024353 old version Z701152
descripción	pesa para filtros int.ø 8x9mm ø ext. 14 L 20mm 17g latón		
Para modelos:	AD-120, AD-120B, AD-120C, AD-120CW, AD-120HY, AD-15, AD-15D, AD-20C-UK, AD-21, AD-21B, AD-21BDD, AD-21C, AD-21D, AD-21DD, AD-21W, AD-45BBT, AD-48, AD-48B, AD-48BDD, AD-48C, AD-48D, AD-48DD, AD-48HY, AD-48W, AD-64, AD-64B, AD-64BBT, AD-64BDD, AD-64C, AD-64CW, AD-64D, AD-64DD, AD-64HY, AD-72, AD-72W, AD-90, AD-90BA, AD-90BBT, AD-90BDD, AD-90DD, ADE-120, ADE-120B, ECO-120, ECO-1200, FI-100, FI-100AR, FI-100BBT-UK, FI-120, FI-120B, FI-120AR+DD...(Otros modelos se puede ver en la tienda web)		

racores de tubo flexible
plástico

1

código	361100	referencia	12036489 RT20620351
descripción	empalme de tubo plástico recto rosca M10x1 tubo ø 6mm UE 1 pzs empalme M10x1		