



**resistencias**

**resistencias para hornos de pizza**



<b>código</b>	418094	<b>referencia</b>	105/65Z15 K105/65 15
<b>descripción</b>	resistencia 1000W 230V L 600mm An 95mm rosca 1/4" distancia de sujeción 86mm longitud de empalme 84mm empalme M4 tubo ø 8.5mm espirales 1 resistencia seca pos. de montaje abajo sujeción 2 orificios		

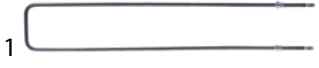

<b>código</b>	418987	<b>referencia</b>	K65/65 18
<b>descripción</b>	resistencia 1000W 230V L 604mm An 113mm rosca 1/4" distancia de sujeción 105mm longitud de empalme 85mm empalme M4 tubo ø 8.5mm espirales 1 resistencia seca pos. de montaje arriba sujeción 2 orificios horno de pizza		







<b>código</b>	419145	<b>referencia</b>	K105/6518 K65/65 15
<b>descripción</b>	resistencia 1000W 230V L 610mm An 94mm rosca 1/4" distancia de sujeción 86mm longitud de empalme 87mm empalme M4 tubo ø 8.5mm espirales 1 resistencia seca pos. de montaje arriba sujeción 2 orificios		



<b>código</b>	419187	<b>referencia</b>	K65/105 15
<b>descripción</b>	resistencia 1600W 230V L 1000mm An 115mm rosca 1/4" distancia de sujeción 106.5mm longitud de empalme 85mm empalme M4 tubo ø 8.5mm espirales 1 resistencia seca pos. de montaje abajo sujeción 2 orificios horno de pizza		





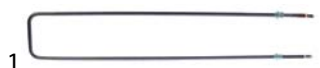

<b>código</b>	418089	<b>referencia</b>	40/60Z6
<b>descripción</b>	resistencia 600W 230V L 480mm An 120mm rosca 1/4" distancia de sujeción 112mm longitud de empalme 42mm empalme conector Faston 6,3mm tubo ø 8.5mm espirales 1 resistencia seca pos. de montaje arriba sujeción 2 orificios		
<b>accesorios para</b>	418089		
	<b>código</b>	361182	<b>referencia</b> —
	tuerca rosca 1/4" H 5mm latón niquelado EC 17 UE 1 pzs		
	<b>código</b>	510417	<b>referencia</b> —
	junta plana fibra ø ext. 20mm int.ø 14mm espesor 2mm UE 1 pzs		
	<b>código</b>	520228	<b>referencia</b> —
	arandela dentada int.ø 15.3mm ø ext. 24mm acero UE 1 pzs para rosca M14		
	<b>código</b>	550262	<b>referencia</b> —
	junta plana cobre ø ext. 20mm int.ø 14mm espesor 2mm		



<b>código</b>	418092	<b>referencia</b>	65/65Z15 K65/65 15 K65/65 15 old version
<b>descripción</b>	resistencia 600W 230V L 595mm An 122mm rosca 1/4" distancia de sujeción 115mm longitud de empalme 84mm empalme M4 tubo ø 8.5mm espirales 1 resistencia seca pos. de montaje abajo sujeción 2 orificios		



<b>código</b>	418090	<b>referencia</b>	40/60Z7 BJ07
<b>descripción</b>	resistencia 700W 230V L 480mm An 120mm rosca 1/4" distancia de sujeción 111mm longitud de empalme 55mm empalme conector Faston 6,3mm tubo ø 8.5mm espirales 1 resistencia seca pos. de montaje abajo sujeción 2 orificios		
<b>accesorios para</b>	418090		
	<b>código</b>	361182	<b>referencia</b> —
	tuerca rosca 1/4" H 5mm latón niquelado EC 17 UE 1 pzs		
	<b>código</b>	510417	<b>referencia</b> —
	junta plana fibra ø ext. 20mm int.ø 14mm espesor 2mm UE 1 pzs		
	<b>código</b>	520228	<b>referencia</b> —
	arandela dentada int.ø 15.3mm ø ext. 24mm acero UE 1 pzs para rosca M14		
	<b>código</b>	550262	<b>referencia</b> —
	junta plana cobre ø ext. 20mm int.ø 14mm espesor 2mm		

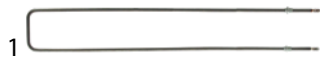

<b>código</b>	418097	<b>referencia</b>	105/105Z18
<b>descripción</b>	resistencia 900W 230V L 1000mm An 195mm rosca M14x1,5 distancia de sujeción 186mm longitud de empalme 85mm empalme M4 tubo ø 8.5mm resistencia seca pos. de montaje arriba sujeción 2 orificios		

## termostatos

### termostatos de control y seguridad

EGO

termostatos de regulación

serie 55.10/19\_



1

<b>código</b>	375253	<b>referencia</b>	40/60Z17
<b>descripción</b>	termóstato T máx 455°C margen de trabajo 85-455°C 1 polos 1NO 16A sonda ø 3.9mm sonda L 228mm capilar 870mm aislamiento del capilar 660mm prensaestopas eje ø 6x4,6mm eje L 23mm posición del eje arriba ángulo de rotación 270°		

### termostatos de seguridad

serie 55.10/19\_



1

<b>código</b>	375191	<b>referencia</b>	40/60Z19
<b>descripción</b>	termóstato de seguridad temp. desconexión 500°C 1 polos 16A sonda ø 3.9mm sonda L 230mm capilar 870mm aislamiento del capilar 660mm prensaestopas bulbo		

## interruptores y pulsadores

### conmutadores de levas

conect./desc.



1

<b>código</b>	300176	<b>referencia</b>	40/60Z18
<b>descripción</b>	conmutador de levas 2 posiciones de conmutación 4NO secuencia de conmutación 0-1 16A eje ø 6x4,6mm eje L 23mm empalme atornillado		

## lámparas

### lámparas de señalización

lámparas de señalización completas

ø 6mm



1

<b>código</b>	359336	<b>referencia</b>	40/60Z12
<b>descripción</b>	lámpara de señalización ø 6mm 230V verde		

### lámpade

lámparas halógenas

para portalámpara GU5,3 / GU10 / GZ5,3



1

<b>código</b>	359496	<b>referencia</b>	65/65Z10 K65/65
<b>descripción</b>	lámpara halógena casquillo GU5,3 12V 50W resis.a la temp. 300°C		

### lámparas para hornos

lámparas de horno específicas del fabricante

FORNITALIA



1

<b>código</b>	359497	<b>referencia</b>	65/65Z9 K65/6509
<b>descripción</b>	cristal de lámpara ø 52mm		



1

<b>código</b>	359495	<b>referencia</b>	65/65Z11
<b>descripción</b>	marco sin portalámpara		



1

<b>código</b>	359498	<b>referencia</b>	65/65Z7 K65/6507
<b>descripción</b>	resorte cristal de lámpara		



			
1			
<b>código</b>	359496	<b>referencia</b>	65/65Z10 K65/65
<b>descripción</b>	lámpara halógena casquillo GU5,3 12V 50W resis.a la temp. 300°C		

lámparas

lámparas halógenas

para portalámparas GU5,3 / GU10

			
1			
<b>código</b>	359496	<b>referencia</b>	65/65Z10 K65/65
<b>descripción</b>	lámpara halógena casquillo GU5,3 12V 50W resis.a la temp. 300°C		

transformadores

transformadores abiertos

con borne de empalme

			
1			
<b>código</b>	401176	<b>referencia</b>	65/65Z26
<b>descripción</b>	transformador primaria 230V secundaria 10/24V 50VA		

para luminotecnia

			
1			
<b>código</b>	401177	<b>referencia</b>	65/65Z24
<b>descripción</b>	transformador primaria 230V secundaria 11.5V 50W		

sensores

sensores específicos del fabricante

			
1			
<b>código</b>	379930	<b>referencia</b>	65/65Z25
<b>descripción</b>	sensor de temperatura termopar K (NiCr-Ni) cable Vetrotex sonda -50 a 1150°C cable -50 a +350°C empalme de dos hilos rosca bulbo ø3x100mm longitud de cable 3.2m		

electrónicas

placas electrónicas

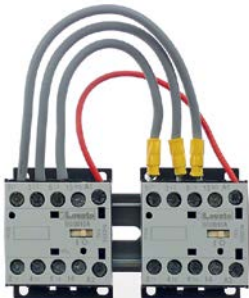
			
1			
<b>código</b>	403643	<b>referencia</b>	K65/65 23 (old version)
<b>descripción</b>	kit de modificación horno de pizza K65 apto para FORNITALIA		

			
1			
<b>código</b>	401178	<b>referencia</b>	105/105Z22 65/65 22 65/65Z22
<b>descripción</b>	placa de control		

			
1			
<b>código</b>	401179	<b>referencia</b>	65/65Z23 K65/65 23 (old)
<b>descripción</b>	placa de potencia horno de pizza K65 apto para FORNITALIA		



1

<b>código</b>	403072	<b>referencia</b>	K65/65 23
<b>descripción</b>	placa de potencia horno de pizza K65 apto para FORNITALIA		

## teclados

### membranas de teclado

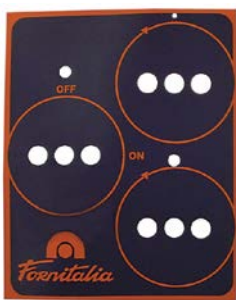

1

<b>código</b>	693371	<b>referencia</b>	40/60Z16
<b>descripción</b>	membrana de teclado		

## ventiladores

### ventilador axial

#### importación



1

<b>código</b>	601158 <sup>1</sup>	<b>referencia</b>	65/65Z20 B65/65 20
<b>descripción</b>	ventilador axial L 119mm An 119mm H 25mm 12VDC 5.4W cojinete rodamiento de bolas empalme cable 300mm plástico ADDA resis.a la temp. -10 a +70°C		

<sup>1</sup>con rodamiento de bolas

## accesorios

### rejillas ventiladores

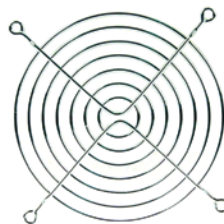

1

<b>código</b>	601206	<b>referencia</b>	65/65Z19
<b>descripción</b>	rejilla de protección ø 115mm distancia de sujeción 105mm para ventilador axial 119mm		

## componentes específicos

### para hornos de pizza

#### muelles



1

<b>código</b>	693369	<b>referencia</b>	65/65Z1 B65/65 01
<b>descripción</b>	resorte de torsión ø 22mm L2 51mm espesor de hilo 3.7mm L1 38mm L3 15mm		

#### vidrios



1

<b>código</b>	693374	<b>referencia</b>	40/60Z1
<b>descripción</b>	vidrio L 258mm An 78mm espesor 4mm rectangular		

1

<b>código</b>	693372	<b>referencia</b>	16/K65/65 65/65Z16 K65/65 16
<b>descripción</b>	vidrio L 418mm An 103mm espesor 4mm rectangular		

**losas de chamota**



1

<b>código</b>	850090	<b>referencia</b>	K105/105 14
<b>descripción</b>	losa de chamota L 1025mm An 500mm H 15mm pos. de montaje abajo tipo de envío ausschließlich per Spedition		
<b>Para modelos:</b>	KCK105/105		



1

<b>código</b>	850092	<b>referencia</b>	K65/105 14
<b>descripción</b>	losa de chamota L 1025mm An 605mm H 15mm pos. de montaje abajo tipo de envío ausschließlich per Spedition		



1

<b>código</b>	850082	<b>referencia</b>	KCK105/105 R2
<b>descripción</b>	losa de chamota L 1030mm An 160mm H 15mm con conducción para sensor pos. de montaje parte lateral izquierda tipo de envío ausschließlich per Spedition		
<b>Para modelos:</b>	KCK105/105		



1

<b>código</b>	850081	<b>referencia</b>	KCK105/105 R5
<b>descripción</b>	losa de chamota L 1030mm An 160mm H 15mm con orificio para lámpara pos. de montaje parte lateral derecha tipo de envío ausschließlich per Spedition		
<b>Para modelos:</b>	KCK105/105		



1

<b>código</b>	850083	<b>referencia</b>	KCK105/105 R3
<b>descripción</b>	losa de chamota L 1045mm An 160mm H 15mm pos. de montaje parte lateral posterior tipo de envío ausschließlich per Spedition		
<b>Para modelos:</b>	KCK105/105		



1

<b>código</b>	850089	<b>referencia</b>	KCK105/65 R4
<b>descripción</b>	losa de chamota L 1045mm An 325mm H 15mm pos. de montaje arriba tipo de envío ausschließlich per Spedition		
<b>Para modelos:</b>	KCK105/65		



			
1			
<b>código</b>	850091	<b>referencia</b>	KCK105/105 R4
<b>descripción</b>	losa de chamota L 1045mm An 520mm H 15mm pos. de montaje arriba tipo de envío ausschließlich per Spedition		
<b>Para modelos:</b>	KCK105/105		

			
1			
<b>código</b>	850118	<b>referencia</b>	K65/105 14
<b>descripción</b>	losa de chamota L 342mm An 605mm H 14mm pos. de montaje abajo tipo de envío ausschließlich per Spedition		
<b>Para modelos:</b>	KCK65/105		

			
1			
<b>código</b>	850094	<b>referencia</b>	K65/65 14
<b>descripción</b>	losa de chamota L 606mm An 313mm H 15mm pos. de montaje abajo UE 2 pzs tipo de envío ausschließlich per Spedition		
<b>Para modelos:</b>	KCK65/65		

			
1			
<b>código</b>	850095	<b>referencia</b>	Bigou Z4 BJ04
<b>descripción</b>	losa de chamota L 625mm An 425mm H 15mm tipo de envío ausschließlich per Spedition		
<b>Para modelos:</b>	BJ60/60		

			
1			
<b>código</b>	850087	<b>referencia</b>	K105/65 14
<b>descripción</b>	losa de chamota L 625mm An 500mm H 15mm pos. de montaje abajo tipo de envío ausschließlich per Spedition		
<b>Para modelos:</b>	KCK105/65		

			
1			
<b>código</b>	850084	<b>referencia</b>	KCK65/65 R5
<b>descripción</b>	losa de chamota L 630mm An 160mm H 15mm con orificio para lámpara pos. de montaje parte lateral derecha tipo de envío ausschließlich per Spedition		
<b>Para modelos:</b>	KCK65/65		

			
1			
<b>código</b>	850085	<b>referencia</b>	KCK65/65 R2
<b>descripción</b>	losa de chamota L 630mm An 160mm H 15mm con orificio para lámpara pos. de montaje parte lateral izquierda tipo de envío ausschließlich per Spedition		
<b>Para modelos:</b>	KCK65/65		

			
1			
<b>código</b>	850086	<b>referencia</b>	KCK65/65 R3
<b>descripción</b>	losa de chamota L 645mm An 160mm H 15mm pos. de montaje parte lateral posterior tipo de envío ausschließlich per Spedition		
<b>Para modelos:</b>	KCK65/65		



1

<b>código</b>	850088	<b>referencia</b>	KCK65/105 R4
<b>descripción</b>	losa de chamota L 645mm An 520mm H 15mm pos. de montaje arriba tipo de envío ausschließlich per Spedition		
<b>Para modelos:</b>	KCK65/105		



1

<b>código</b>	850123	<b>referencia</b>	KCK65/65 R4
<b>descripción</b>	losa de chamota L 645mm An 640mm H 15mm pos. de montaje arriba tipo de envío ausschließlich per Spedition		
<b>Para modelos:</b>	KCK65/65		

puertas



1

<b>código</b>	693368	<b>referencia</b>	65/65Z2 K65/65 02
<b>descripción</b>	casquillo para puerta		

pomos

pomos universales



1

<b>código</b>	110253	<b>referencia</b>	40/60Z13
<b>descripción</b>	pomo interruptor marca cero T máx°C°C ø 50mm eje ø 6x4,6mm parte plana arriba negro		

pomos personalizados para fabricantes

FORNITALIA



1

<b>código</b>	111742	<b>referencia</b>	65/65Z13
<b>descripción</b>	pomo potenciómetro ø 78mm eje ø 6x4,6mm parte plana arriba negro		



1

<b>código</b>	111740	<b>referencia</b>	40/60Z15 BJ15
<b>descripción</b>	pomo termostato T máx 450°C ø 49mm eje ø 6x4,6mm parte plana arriba negro margen de trabajo 85-450°C ángulo de rotación 270°		

manillas y volantes

manillas cónicas



1

<b>código</b>	693370	<b>referencia</b>	65/65Z17
<b>descripción</b>	manilla cónica rosca M12x1,5 rosca L 12,5mm		

## filtros

### filtros para aparatos

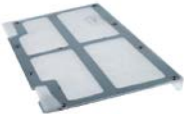
			
1			
<b>código</b>	693373	<b>referencia</b>	65/65Z21 K65/65 21
<b>descripción</b>	filtro		

## muelles

### muelles de torsión

			
1			
<b>código</b>	693369	<b>referencia</b>	65/65Z1 B65/65 01
<b>descripción</b>	resorte de torsión ø 22mm L2 51mm espesor de hilo 3.7mm L1 38mm L3 15mm		