

resistencias

cables de calefacción

cables de calefacción para desagües



código	417615	referencia	33575155/0 CM33575155/0
descripción	cable de calefacción para desagüe 25W 230V 50Hz ø 6.3mm L 3000mm L1 (sin calentam.) 1300mm L2 (con calentam.) 1700mm silicona		

termostatos

termostatos de control y seguridad

RANCO

termostatos de seguridad

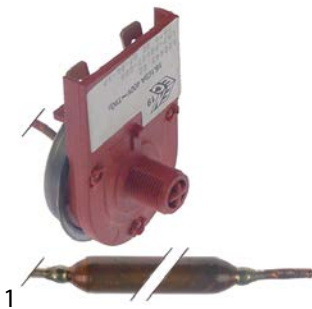

código	375832	referencia	CMNM62044300
descripción	termostato de seguridad T máx 70°C margen de trabajo 0-70°C 1 polos 1NO 16A sonda ø 8mm sonda L 60mm capilar 870mm aislamiento del capilarmm prensaestopas eje ømm eje Lmm posición del eje ángulo de rotación° material de bulbo cobre temp. desconexión 70°C		

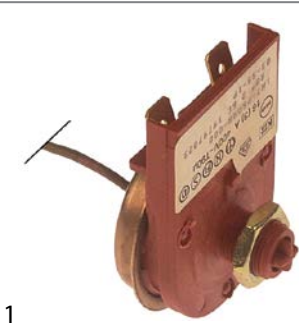

código	390583	referencia	19797023/0 CM19797023/0
descripción	termostato de seguridad T máx 80°C margen de trabajo°C 1 polos 1NC 16A sonda ø 9mm sonda L 50mm capilar 800mm aislamiento del capilarmm prensaestopas eje ømm eje Lmm posición del eje ángulo de rotación° material de bulbo cobre con sensor unión roscada M10x0,75 temp. desconexión 80°C		
Para modelos:	N21S, N25SW, N45L, N45S, N45SW, N70SW, N90SW		

termostatos para frío

DANFOSS

termostatos de servicio DANFOSS

Todos los termostatos de Danfoss se suministran con material de fijación

aplicaciones:

390552 - **frigorífico (a -12 °C)

390553 - **frigorífico (a -12 °C) con tecla descongelación

390554 - **/**frigorífico (a -12 °/-18°C) con desconge. auto.

390555 - frigorífico assorbinento

390557 - equipo remoto señal activa

390558 - equipo remoto señal pasiva

390559 - botellero y bebidas frías



código	390559	referencia	077B7008 19797007/0 19797012/0 CM19797007/0 CM19797012/0
descripción	termostato tipo 077B7008 capilar 2000mm margen de trabajo -8,5 a +11,5°C sonda ømm sonda Lmm		

termostatos de regulación



código	390268	referencia	19797012/0 CM19797012/0
descripción	termostato tipo 077B0070L capilar 2000mm		



código	390269	referencia	19797011/0 CM19797011/0
descripción	termostato tipo 077B2033 capilar 2000mm margen de trabajo -34 a -15°C		

RANCO

serie K22



código 390582 **referencia** 19797025/0
CM19797025/0

descripción termostato RANCO tipo K22-L1529 sonda ø 7mm sonda L 108mm capilar 1400mm

Para modelos: N25L, N25LBI, N25LW, N35BI, N35S, N35SW, N45L, N45S, N45SW, N55L, N55LW, N55S, N55SW, N70S, N70SW, N90L, N90LW, N90S, N90SW



código 390646 **referencia** nicht in Preisliste

descripción termostato RANCO tipo K22-L1075 capilar 2900mm bulbo ø9,5x-107mm



código 390644 **referencia** nicht in Preisliste

descripción termostato RANCO tipo A22-1297-000 capilar 1500mm bulbo ø10x100mm



código 390209 **referencia** 19797009/0
CM19797009/0

descripción termostato RANCO tipo K22L1020 sonda ø 9mm sonda L 40mm capilar 2000mm margen de trabajo -20,5 a -1,5°C

Para modelos: N21S



código 390737 **referencia** 62020101
CMCS62020101
CMNM62020101
CMNX62020101

descripción termostato RANCO tipo K22-L1074 sonda ø 9mm sonda L 42mm capilar 1450mm margen de trabajo -19 a -1°C



código 390279 **referencia** N/A

descripción termostato RANCO tipo K22L3022 sonda ø 9mm sonda L 35mm capilar 1600mm

serie K50



código 390642 **referencia** 19797019/0
CM19797019/0

descripción termostato RANCO tipo K50-L3218 sonda ø 2mm sonda Lmm capilar 1230mm refrigeración 1NO M10x0,75





código 390581 **referencia** 19797026/0
CM19797026/0
I-35

descripción termostato RANCO tipo K50-S3595 sonda ø 2mm sonda Lmm capilar 2000mm

Para modelos: N21S

			
código	390444	referencia	N/A
descripción	termóstato RANCO tipo K50-L3074 sonda ø 9mm sonda L 40mm capilar 560mm		

<p>serie K55</p> 			
código	390210	referencia	3824917
descripción	termóstato RANCO tipo K55L1042 capilar 1100mm margen de trabajo +1,7 a +9,5°C bulbo ø10x110mm		

			
código	390283	referencia	19797017/0 19797302/0 CM19797017/0 CM19797302/0
descripción	termóstato RANCO tipo K55L5081 capilar 1100mm margen de trabajo °C bulbo ø10x110mm		
Para modelos:	N140, N20L, N20WL, N25BI, N25L, N25LBI, N25LW, N25S, N25SW, N35BI, N35S, N35SW, N45L, N45S, N45SW, N50BI, N50BIW, N55L, N55LW, N55S, N55SW		

			
código	390284	referencia	19797018/0 19797303 CM19797018/0
descripción	termóstato RANCO tipo K55L5082 capilar 1500mm margen de trabajo °C bulbo ø10x110mm		
Para modelos:	N70S, N70SW, N90L, N90LW, N90S, N90SW		

<p>serie K61</p> 			
código	390212	referencia	29090002/0 CM29090002/0
descripción	termóstato RANCO tipo K61L1500 sonda ømm sonda Lmm capilar 750mm T caliente -11.5°C T fría 22°C		

			
código	390586	referencia	19797031/0 CM19797031/0
descripción	termóstato RANCO tipo K61L1504 sonda ø 2mm sonda Lmm capilar 1800mm T caliente 11.5°C T fría 22°C		

			
código	379516	referencia	62026416 CF62026416 CMCF62026416 CMNM62026416
descripción	termóstato RANCO tipo K61L1508 sonda ø 2mm sonda Lmm capilar 1800mm		

<p>otros fabricantes</p> 			
código	390485	referencia	nicht in Preisliste
descripción	termóstato		



1

código	390659	referencia	nicht in Preisliste
descripción	termostato sonda ø 2.5mm capilar 90mm		

accesorios

clips para bulbo

pinzas

para termostato



1

código	695672	referencia	25726140/0 CM25726140/0
descripción	clip para bulbo L 12mm An 27mm H 18mm agujero ø 9.5mm		
Para modelos:	N140, N25L, N25LBI, N25LW, N35BI, N35S, N35SW, N45S, N45SW, N50BI, N50BIW, N55L, N55LW, N55S, N55SW, N70S, N70SW, N90L, N90LW, N90S, N90SW		



1

código	695661	referencia	25726141/0 CM25726141/0
descripción	clip para bulbo L 40mm An 25mm H 18mm agujero ø 9.5mm		
Para modelos:	N140, N25L, N25LBI, N25LW, N35BI, N35S, N35SW, N45S, N45SW, N50BI, N50BIW, N55L, N55LW, N55S, N55SW, N70S, N70SW, N90L, N90LW, N90S, N90SW		

interruptores y pulsadores

interruptores/pulsadores basculantes

25,5x25mm



1

código	347115 ¹	referencia	33400044/0 CM33400044/0
descripción	interruptor basculante medida de montaje 25,5x25mm claro 2CO 250V 16A iluminado empalme conector Faston 6,3mm temperatura ambiente máx. 85°C protección IP40		

¹iluminado

30x11mm



1

código	301013	referencia	33400049/0 62024202 CM33400049/0
descripción	interruptor basculante medida de montaje 30x11mm negro 1CO 250V 16A empalme conector Faston 6,3mm temperatura ambiente máx. 85/125°C protección IP40		
Para modelos:	N21S		



1

código	348107	referencia	33400046/0 CM33400046/0
descripción	pulsador basculante medida de montaje 30x11mm negro 1NO 250V 16A I empalme conector Faston 6,3mm temperatura ambiente máx. 85/125°C protección IP40		
Para modelos:	N401M, N501M		



1

código	301012	referencia	33400053/0 CM33400053/0
descripción	interruptor basculante medida de montaje 30x11mm verde 1NO/lámpara 250V 16A 0-I empalme conector Faston 6,3mm temperatura ambiente máx. 85/125°C protección IP40		
Para modelos:	N21S, N25L, N25LW, N25S, N25SW, N35S, N35SW, N45L, N45S, N45SW, N55L, N55LW, N55S, N55SW, N70S, N70SW, N90L, N90LW, N90S, N90SW		

30x22mm



1

código	347074	referencia	nicht in Preisliste
descripción	interruptor basculante medida de montaje 30x22mm negro/naranja 1NO/lámpara 250V 16A frío empalme conector Faston 6,3mm temperatura ambiente máx. 125/55°C protección IP65 con tapa		

otros



1

código	347064	referencia	nicht in Preisliste
descripción	interruptor basculante medida de montaje 40x18mm negro 1CO 250V 10A		

accesorios para

código	694188	referencia	—
descripción	mazo de cables 3 polos L 170mm temperatura constante 105°C tipo de conector Faston 6,3mm		





interruptores pulsantes y pulsadores

19x13mm			
 <p>1</p>			
código	347079 ¹	referencia	nicht in Preisliste
descripción	interruptor pulsante medida de montaje 19x13mm verde 2NO 250V 16A iluminado empalme conector Faston 6,3mm temperatura ambiente máx. 125°C protección IP65 con tapa		

¹iluminado

20,6x16,4mm			
 <p>1</p>			
código	348108	referencia	33400060/0 CM33400060/0
descripción	interruptor pulsante medida de montaje 20,6x16,4mm cromo 1NO 250V 16A empalme conector Faston 6,3mm temperatura ambiente máx. 85°C protección IP40		

 <p>1</p>			
código	347205	referencia	33400060/0 CM33400060/0
descripción	interruptor pulsante medida de montaje 20,6x16,4mm cromo 2NO 250V 16A empalme conector Faston 6,3mm temperatura ambiente máx. 85°C protección IP40		

ø 7mm			
 <p>1</p>			
código	347069	referencia	I-1682
descripción	pulsador montaje ø 7mm rojo 1NO 24V 4A con cable 500mm empalme cable temperatura ambiente máx. 85°C protección IP40 para máquina de hielo		

interruptor de palanca

M12x0,75			
 <p>1</p>			
código	347068	referencia	33400019/0 33400027/0 81453376/0 CM33400019/0 CM33400027/0 CM81453376/0
descripción	interruptor de palanca rosca M12x0,75 2NO 250V 16A ON-OFF-ON conector Faston 6,3mm con posición neutra		

microinterruptores

accionado por palanca			
 <p>1</p>			
código	347063	referencia	25474581/0 CM25474581/0
descripción	microinterruptor 250V 15A 1CO empalme conector Faston 6,3mm temperatura ambiente máx. 105°C longitud de palanca 37mm		

 <p>1</p>			
código	345345	referencia	19410207/0 CM19410207/0
descripción	microinterruptor con manilla 250V 16A 1CO empalme conector Faston 6,3mm L 78mm temperatura ambiente máx. 85°C distancia de sujeción 22mm tipo X662-88-J27 fuerza de accionamiento: 40g longitud de palanca 69mm		

 <p>1</p>			
código	346875	referencia	19410200/0 CM19410200/0
descripción	microinterruptor 3 con manilla 250V 15A 1CO empalme atornillado L 112mm L1 49mm temperatura ambiente máx. 125°C distancia de sujeción 25mm tipo Z-15HW24-B fuerza de accionamiento: 5g longitud de palanca 125mm		

 <p>1</p>			
código	345270	referencia	19410200/0 CM19410200/0
descripción	microinterruptor con manilla 250V 16A 1CO empalme conector Faston 6,3mm temperatura ambiente máx. 85°C distancia de sujeción 25mm tipo C99ZP3 fuerza de accionamiento: 30g longitud de palanca 140mm		

 <p>1</p>			
código	346887	referencia	nicht in Preisliste
descripción	microinterruptor con manilla 250V 15A 1NC empalme conector Faston 6,3mm temperatura ambiente máx. 125°C longitud de palanca 60mm		



1

código	347077	referencia	nicht in Preisliste
descripción	microinterruptor con manilla 250V 15A 2CO empalme conector Faston 6,3mm temperatura ambiente máx. 85°C longitud de palanca 62mm		



1

código	345361	referencia	19410205/0 CM19410205/0
descripción	microinterruptor con manilla 250V 5A 1NO/1NC empalme conexión para soldadura temperatura ambiente máx. 85°C tipo 83109004 longitud de palanca 43mm		

accionados por palanca de rodillo

microinterruptores



1

código	345253	referencia	19410201/0 19410209/0 CM19410201/0 CM19410209/0
descripción	microinterruptor con palanca de rodillo 250V 15A 1CO empalme conector Faston 6,3mm L 28mm L1 37mm temperatura ambiente máx. 125°C distancia de sujeción 22mm tipo RL6-1-F-GE-P12-5-L fuerza de accionamiento: 80g gris longitud de palanca 28mm		
Para modelos:	N140, N20L, N20WL, N25BI, N25L, N25LBI, N25LW, N25S, N25SW, N35BI, N35S, N35SW, N45L, N45S, N45SW, N50BI, N50BIW, N55L, N55LW, N55S, N55SW, N70S, N70SW, N90L, N90LW, N90S, N90SW		

versión pesada



1

código	346874	referencia	19410300/0 CM19410300/0
descripción	microinterruptor con palanca de rodillo 250V 16A 1CO empalme atornillado L 29mm L1 49mm temperatura ambiente máx. 85°C distancia de sujeción 26mm tipo Z-15GW22-B fuerza de accionamiento: 120g longitud de palanca 25mm		

INTERRUPTORES Y PULSADORES ICEMATIC

con piezas de montaje



1

código	346876	referencia	19410208/0 81401140 CM19410208/0
descripción	microinterruptor con palanca de rodillo 250V 16A 1CO empalme conector Faston L 35mm L1 28mm temperatura ambiente máx. 125°C distancia de sujeción 22mm tipo V-166-1CR5 fuerza de accionamiento: 86g		
Para modelos:	N20L, N20WL, N25BI, N25L, N25LBI, N25LW, N25S, N25SW, N35BI, N35S, N35SW		

accionados por rodillo

rollo 0°



1

código	347080	referencia	33400026/0 CM33400026/0
descripción	microinterruptor con rueda de presión 10A 1CO empalme atornillado temperatura ambiente máx. 85°C rosca M12x1		

interruptores de flotador



1

código	403551	referencia	81300027/0 CM81300027/0
descripción	interruptor de flotador 1CO 250V 4A F6,3		
accesorios para	403551		
	código	403552	referencia 25725558/0 CM25725558/0
	soporte for float switch L 100mm An 37mm H 41mm acero inoxidable espesor 2mm		



1

código	345365	referencia	81404080/0 81409179/0 CM81404080/0 CM81409179/0
descripción	interruptor de flotador 250V 16A 1CO conector Faston 6,3mm L 150mm temperatura ambiente máx. 125°C distancia de sujeción 23mm tipo EF83161.5 fuerza de accionamiento: 5g negro		
Para modelos:	N20L, N20WL, N25BI, N25L, N25LBI, N25LW, N25S, N25SW, N35BI, N35S, N35SW, N45L, N45S, N45SW, N50BI, N50BIW, N55L, N55LW, N55S, N55SW, N70S, N70SW, N90L, N90LW, N90S, N90SW		



1

código	347088	referencia	81449091/0 CM81449091/0
descripción	interruptor de flotador con varilla 250V 16A 1CO conector Faston 6,3mm L 130mm temperatura ambiente máx. 125°C distancia de sujeción 23mm tipo EF83161.5 fuerza de accionamiento: 5g negro		
Para modelos:	N140		

flotadores

1

código	695036	referencia	29025013/0 CF66058500 CF78312700 CM29025013/0 CMCF66058500 CMCF78312700
descripción	flotador para máquina de hielo ø 75mm L 115mm H 40mm plástico		
Para modelos:	F100, F120, F125C, F200, F80C, F80WC, SF300, SF500, SFN1000, SFN1000W		

1

código	696637	referencia	25360110/3 CM25360110/3
descripción	flotador sin imán ø 18.5mm L 77mm An 19mm H 34mm PVC para ICEMATIC		

interruptores centrífugos

1

código	346986	referencia	nicht in Preisliste
descripción	interruptor centrífugo		

1

código	347062	referencia	nicht in Preisliste
descripción	interruptor centrífugo		

interruptores de contacto

1

código	402043	referencia	CF65067402 CMCF65067402
descripción	barrera luminosa L 180mm An 35mm H 46mm		
Para modelos:	F100, F120, F200, SF300, SF500, SFN1000, SFN1000W		

1

código	402009	referencia	29040018 29040018/0 33580175/0 CF65067400 CM29040018/0 CM33580175/0 CMCF65067400
descripción	barrera luminosa L 310mm An 35mm H 47mm		
Para modelos:	F80C, F80WC		



código	402018	referencia	nicht in Preisliste
descripción	barrera luminosa para espesor hielo juego		

interruptores magnéticos

26x12,5mm



código	348110 ¹	referencia	33210022/0 CM33210022/0
descripción	interruptor magnético L 26mm An 12.5mm 1NO 300V 0.5A P máx. 10W empalme conector codificado longitud del cable 1500mm		

¹con conexión codificado

36x13mm

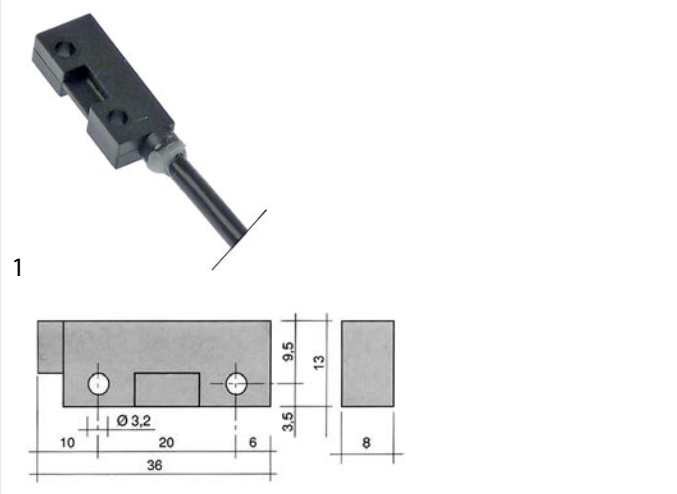

código	345118 ¹	referencia	33210018/0 33210019/0 CM33210018/0 CM33210019/0
descripción	interruptor magnético L 36mm An 13mm 1NO 250V 1A P máx. 50W empalme cable longitud del cable 980mm		
Para modelos:	N131M, N200M, N200MW, N201M, N300M, N300MW, N301M, N401M, N500M, N501M		
accesorios para	345118		
	código	345399	referencia 19355004/0 CM19355004/0
	imán ø 3.3mm L 40mm H 8mm An 13mm dist. del agujero 30mm M3		

¹con conexión codificado

M10x0,75

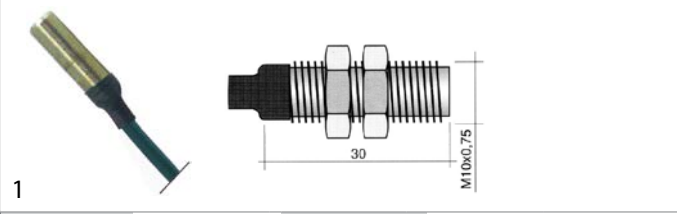

código	345632	referencia	33580132/0 CM33580132/0
descripción	interruptor magnético rosca M10x0,75 1NO 250V 0.5A P máx. 50W empalme cable longitud del cable 2000mm tipo 102		
Para modelos:	T20, T20C, T20R		
accesorios para	345632		
	código	100779	referencia —
	tuerca rosca M10x0,75 H 3mm EC 14 inox UE 2 pzs		



accesorios

imanes



1

código	348111	referencia	19355010/0 193550101/0 CM19355010/0 CM193550101/0
descripción	imán L 26mm H 7.45mm An 12.45mm dist. del agujero 17.5mm M3 agujero ø 3.2mm		



1

código	347059	referencia	19355007/0 CM19355007/0
descripción	imán L 40mm H 8mm An 13.2mm dist. del agujero 30mm		
Para modelos:	N131M, N201M, N301M, N401M, N501M		



1

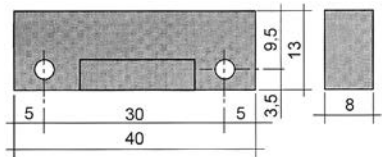

código	345399	referencia	19355004/0 CM19355004/0
descripción	imán ø 3.3mm L 40mm H 8mm An 13mm dist. del agujero 30mm M3		
Para modelos:	N200M, N200MW, N300M, N300MW		

otros



1

código	347066	referencia	nicht in Preisliste
descripción	interruptor de seguridad 250V ø 58mm H 40mm 15A		

lámparas

lámparas de señalización

lámparas de señalización completas

ø10mm

con casquillo roscado



1

código	359380	referencia	33470507/0 CM33470507/0
descripción	lámpara de señalización ø 10mm 230V rojo empalme conector Faston 6,3mm casquillo portalámpara roscado		
Para modelos:	N21S, N25L, N25LW, N25S, N25SW, N35S, N35SW, N45L, N45S, N45SW, N55L, N55LW, N55S, N55SW, N70S, N70SW, N90L, N90LW, N90S, N90SW		

ø13mm

con casquillo enchufable



1

código	359141	referencia	33576295
descripción	lámpara de señalización ø 13mm rojo 230V empalme conector Faston 6,3mm resis.a la temp. 120°C UE 1 pzs		

30x22mm



1

código	359155	referencia	33400002 33400002/0 CM33400002/0
descripción	lámpara de señalización medida de montaje 30x22mm 230V rojo empalme conector Faston 6,3mm resis.a la temp. 125°C tipo RL2		

temporizadores

temporizadores de programa



1

código	360377	referencia	nicht in Preisliste
descripción	temporizador		



contactores

GENERAL ELECTRIC (AEG)

contactores de potencia



1

código	380859	referencia	33730609/0 CM33730609/0
descripción	contactor de potencia AC1 25A 230VAC (AC3/400V) 12A/5,5kW contactos principales 3NO contactos auxiliares 1NC empalme empalme atornillado tipo AEG LS701E		

LOVATO

contactores de potencia



1

código	380579	referencia	I-1673
descripción	contactor de potencia AC1 16A 230VAC (AC3/400V) 9A/4kW contactos principales 3NO contactos auxiliares 1NO empalme empalme atornillado tipo 11MC9102205060		



1

código	380888	referencia	33730712 33730712/0 CM33730712/0
descripción	contactor de potencia AC1 20A 230VAC (AC3/400V) 12A/5,7kW contactos principales 3NO contactos auxiliares 1NC empalme empalme atornillado tipo 11BG1201A230		
Para modelos:	N131M, N201M, N301M, N401M		



código	360665 ¹	referencia	81414561/0 81414562/0 CM19800012/0 CM81414561/0 CM81414562/0
descripción	temporizador CDC Kit motores 1 cámaras 2 tiempo de funcionamiento 12min aliment. 230V 50-60Hz eje ømm eje Lmm tipo de motor 4902F1		

¹con kit cable



código	360754	referencia	19800012/0
descripción	temporizador CDC motores 1 cámaras 2 tiempo de funcionamiento 12min aliment. 230V 50-60Hz eje ømm eje Lmm tipo de motor 4902F1		

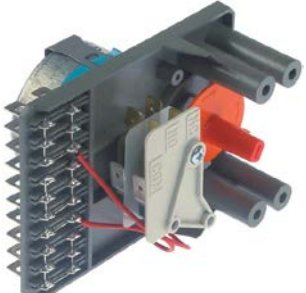

código	360370	referencia	19800001/0 CM19800001/0
descripción	temporizador FIBER P36 motores 1 cámaras 2 tiempo de funcionamiento 12min aliment. 230V 50-60Hz eje ømm eje Lmm N° fabricante P365JR2J536 tipo de motor M51BJ0R6400		
Para modelos:	N215		
repuestos para	360370	código	360673
descripción	kit de motor piñón ø 6.8mm dientes 15 aliment. 230V tensión AC 50/60Hz sentido de rotación en sentido horario ø motor 48mm H 18.5mm tipo motor UDS40NE1RNZ165 longitud del cable 150mm con soporte		

1

código	380574	referencia	nicht in Preisliste
descripción	contactor de potencia AC1 25A 230VAC (AC3/400V) 12A/5,7kW contactos principales 3NO contactos auxiliares 1NO empalme empalme atornillado tipo B12		



1

código	380185	referencia	19620103/0 CM19620103/0
descripción	relé de potencia Italiana Relè 230VAC 30A 1NO empalme F6,3 lengüeta de sujeción medidas 36,5x32,2x51,8mm N° fabricante A10-230AC-FA		
Para modelos:	T14, T5		

otros

contactores de potencia



1

código	380578	referencia	nicht in Preisliste
descripción	contactor de potencia aliment. 208/240V AC1 30A contactos principales 2NO empalme conector Faston 6,3mm		

con contactos enchufables

conectores redondos, 8 contactos



1

código	380134	referencia	19620100/0 CM19620100/0	
descripción	relé de potencia Italiana Relè 230VAC 10A 2CO empalme empalme enchufable redondo 8 polos N° fabricante C42-230VAC 90.26/ZVE8 250V			
accesorios para	380134			
	código	380137	referencia	—
	zócalo de relé 8 polos empalme empalme enchufable redondo 8 polos medidas 65x28x40mm 380V tensión AC 10A Italiana Relè N° fabricante ZVE8			
	código	380638	referencia	19050010/0 CM19050010/0
	zócalo de relé 8 polos medidas 51x41x23mm 250V 10A FINDER N° fabricante 90.26			

relés

relés de potencia

con lengüeta de sujeción



1

código	380312	referencia	19620107/0 CM19620107/0
descripción	relé de potencia FINDER 230VAC 10A 3CO empalme conector Faston 4,8mm lengüeta de sujeción medidas 52x32,2x36,5mm N° fabricante 60.63.8.230.0000		
Para modelos:	N140, N20L, N20WL, N25BI, N25L, N25LBI, N25LW, N25S, N25SW, N35BI, N35S, N35SW, N45L, N45S, N45SW, N50BI, N50BIW, N55L, N55LW, N55S, N55SW, N70S, N70SW, N90L, N90LW, N90S, N90SW		

portarelés



1

código	380638	referencia	19050010/0 CM19050010/0
descripción	zócalo de relé 8 polos medidas 51x41x23mm 250V 10A FINDER N° fabricante 90.26		

relés de temporización

relés de temporización



1	código	350129	referencia	nicht in Preisliste
	descripción	relé de temporización FIBER R11B52307F0 margen de tiempo 6s-30min 230VAC 2x6A 1NO/1CO empalme conector Faston 6,3mm		



1	código	380584	referencia	nicht in Preisliste
	descripción	relé de temporización SYRELEC BAR.F margen de tiempo 0-10min 220-240VAC 5A 1CO empalme atornillado		

otros



1	código	380580	referencia	33580057/0 CM33580057/0
	descripción	relé empalme con cable para bomba		

transformadores

transformadores abiertos

con clavija



1	código	401827	referencia	nicht in Preisliste
	descripción	transformador primaria 230V secundaria 24V 75VA 50/60Hz		

controladores electrónicos

CAREL

controladores de punto de refrigeración

versión empotrada



1	código	381365	referencia	26118434/0 CM26118434/0
	descripción	controlador electrónico CAREL IR3350EN00 medida de montaje 71x29mm profundidad de montaje 56mm aliment. 230V tensión AC salidas de relé 1 CO-8A(4) NTC NTC DI presente presente presente presente protección IP65 display 3 dígitos		

otros

controladores de punto de refrigeración



1	código	378230	referencia	26117881/0 CM26117881/0
	descripción	controlador electrónico tipo HTW311 medida de montaje 71x29mm aliment. 12V tensión AC entrada de medición 1 NTC/RTC AC1 (R1) 10A		

sensores

sensores universales

sondas de temperatura



1	código	379557	referencia	33580115/0 33580116/0 CM33580115/0 CM33580116/0
	descripción	sensor de temperatura NTC 10kOhm cable silicón sonda -40 a +110°C cable -50 a +180°C bulbo ø6x35mm longitud de cable 1.5m sin racor de dos hilos		



1	código	379162	referencia	33580099/0 CM33580099/0
	descripción	sensor de temperatura NTC 10kOhm cable termoplástico sonda -40 a +110°C cable -40 a +110°C bulbo ø6x14mm longitud de cable 6m de dos hilos		
	Para modelos:	T14, T20, T20C, T20R, T5		

código	381343	referencia	33580099/1 CM33580099/1
descripción	sensor de temperatura PTC 1kOhm cable termoplástico sonda -50 a +150°C cable -40 a +110°C bulbo ø6x14mm longitud de cable 4.8m de dos hilos		

código	381336	referencia	33580265/0 CM33580265/0
descripción	sensor NTC 2kOhm cable PVC sonda -40 a +110°C cable -10 a 100°C empalme conector bulbo ø6x60mm longitud de cable 1.5m		

sondas al corazón

código	379549	referencia	33580149 33580149/0 CM33580149/0
descripción	sensor al corazón PTC 1kOhm cable PVC sonda -50 a +150°C cable -10 a 100°C bulbo ø6x110mm longitud de cable 3.5m asidero ø 8mm longitud de asidero 120x35mm de dos hilos L1 120mm L2 130mm		
Para modelos:	T14, T20, T20C, T20R, T5		

código	381344	referencia	CF62040411 CMCF62040411
descripción	sensor PTC 2kOhm cable PVC sonda -50 a +150°C cable -10 a 100°C empalme conector bulbo ø5x50mm longitud de cable 1.7m		
Para modelos:	SFN1000, SFN1000W		

código	379628	referencia	nicht in Preisliste
descripción	sensor de temperatura 2x NTC 10K cable PVC sonda -40 a +110°C cable -10 a 100°C empalme conector codificado rosca bulbo ø6,5x-45mm longitud de cable 0,4/0,55m		

código	379564	referencia	nicht in Preisliste
descripción	sensor de temperatura 2x NTC 10K cable PVC sonda -40 a +110°C cable -10 a 100°C empalme conector codificado rosca bulbo ø6,5x-45mm longitud de cable 0,7/1,3m		

sensores específicos del fabricante

sensores

código	381339	referencia	33580298/0 CF62051900 CM33580298/0 CMCF62051900
descripción	sensor NTC 10kOhm cable PVC sonda -40 a +110°C cable -10 a 100°C empalme conector rosca bulbo ø5x50mm longitud de cable 1.2m		

código	381337	referencia	33580297/0 CF62051901 CM33580297/0 CMCF62051901
descripción	sensor de temperatura NTC 10kOhm cable PVC sonda -40 a +110°C cable -10 a 100°C empalme conector rosca bulbo ø5x40mm longitud de cable 1.5m		

código	381338	referencia	33580135/0 CM33580135/0
descripción	sensor NTC 2,2kOhm cable PVC sonda -40 a +110°C cable -10 a 100°C empalme conector rosca bulbo ø5x50mm longitud de cable 2m		
Para modelos:	N500M		

código	402139	referencia	33580101/0 CM33580101/0
descripción	sensor de temperatura NTC 2,2kOhm cable PVC sonda -40 a +110°C cable -10 a 100°C empalme conector rosca bulbo ø5x60mm longitud de cable 1m		
Para modelos:	N131M, N200M, N200MW, N201M, N300M, N300MW, N301M, N401M, N501M		



1 			
código	402006	referencia	29070010 33580065/0 33580065/1 CM33580065/0 CM33580065/1
descripción	sensor de temperatura PTC 2kOhm cable PVC sonda -50 a +150°C cable -10 a 100°C empalme conector rosca bulbo ø5x60mm longitud de cable 1.5m		

1 			
código	378231	referencia	33580066/1 CM33580066/1
descripción	sensor de temperatura PTC 2kOhm cable PVC sonda -50 a +150°C cable -10 a 100°C empalme conector rosca bulbo ø5x60mm longitud de cable 1.9m		

1 			
código	402191	referencia	29070014/0 CF62040401 CM29070014/0 CMCF62040401
descripción	sensor de temperatura PTC 2kOhm cable TPE sonda -50 a +150°C cable -40 a +110°C empalme conector rosca bulbo ø5x20mm longitud de cable 1.8m		
Para modelos:	F100, F100C, F120, F125C, F200, F80C, F80WC, SF300, SF500		

1 			
código	402005	referencia	29070013 29070013/0 620404.10 CF62040410 CM29070013/0 CMCF62040410
descripción	sensor de temperatura PTC 2kOhm cable TPE sonda -50 a +150°C cable -40 a +110°C empalme conector rosca bulbo ø6x50mm longitud de cable 1.6m		
Para modelos:	F100, F100C, F120, F125C, F200, F80C, F80WC, SF300, SF500, SFN1000, SFN1000W		

sondas al corazón





1			
código	379549	referencia	33580149 33580149/0 CM33580149/0
descripción	sensor al corazón PTC 1kOhm cable PVC sonda -50 a +150°C cable -10 a 100°C bulbo ø6x110mm longitud de cable 3.5m asidero ø 8mm longitud de asidero 120x35mm de dos hilos L1 120mm L2 130mm		
Para modelos:	T14, T20, T20C, T20R, T5		

sensores Hall

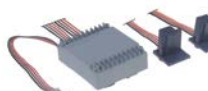

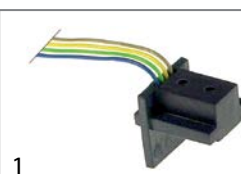
1 			
código	402140	referencia	I-1637
descripción	Sensor Hall doble L 29mm An 26mm H 26mm distancia de sujeción 10mm longitud del cable 700mm		



1 			
código	402044	referencia	29070015/0 CF62040403 CM29070015/0 CMCF62040403
descripción	Sensor Hall L 29mm An 26mm H 26mm distancia de sujeción 10mm longitud del cable 1250mm		
Para modelos:	F100, F100C, F120, F125C, F200, F80C, F80WC, SF300, SF500, SFN1000, SFN1000W		

			
1			
código	402146	referencia	I-1638
descripción	Sensor Hall L 29mm An 26mm H 26mm distancia de sujeción 10mm longitud del cable 700mm		

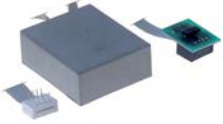
			
1			
código	402141	referencia	I-1636
descripción	Sensor Hall longitud del cable 550mm		

accesorios

otros

			
1			
código	402040	referencia	29015055 29015055/0 29070016 CF62040404 CM29015055/0 CMCF62040404
descripción	cable para electrodos de nivel longitud del cable 1800mm		
Para modelos:	F100, F120, F125C, F200, SF300, SF500, SFN1000, SFN1000W		

electrónicas

cajas de platinas

			
1			
código	695663	referencia	29070021/0 CF66054600 CM29070021/0 CMCF66054600
descripción	caja placa electrónica L 230mm An 142mm H 57mm		
Para modelos:	F100C		

			
1			
código	694206	referencia	19190397/0 CF66054700 CM19190397/0 CMCF66054700
descripción	tapa placa electrónica L 180mm An 110mm H 9mm		
Para modelos:	F100, F120, F200, SF300, SF500		
accesorios para	694206		
	código	referencia	—
	694205		
	caja placa electrónica L 180mm An 110mm H 40mm		

			
1			
código	694796	referencia	29015057/0 CM29015057/0
descripción	tapa placa electrónica L 205mm An 125mm H 14mm plástico		

placas electrónicas

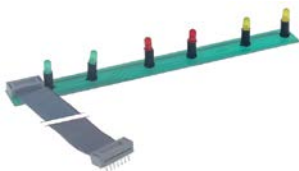
			
1			
código	401806	referencia	I-1666
descripción	placa de display		

			
1			
código	401803	referencia	33580174/0 CM33580174/0
descripción	placa de display máquina de hielo en cubitos F80C longitud del cable 900mm con LED		
Para modelos:	F80C, F80WC		

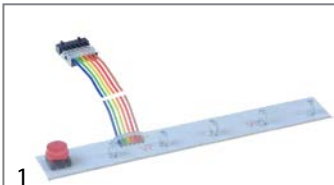

1

código	401805	referencia	33580151/0 CM33580151/0
descripción	placa de display máquina de hielo en cubitos N201/N301//N501 L 170mm An 25mm		
Para modelos:	N131M, N201M, N301M, N401M, N501M		



1

código	402145	referencia	33580084/0 CM33580084/0
descripción	placa de display para máquina de hielo longitud del cable 1500mm con LED		

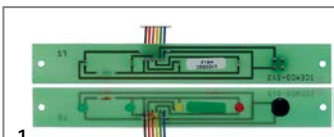

1

código	401801	referencia	33580024/0 CM33580024/0
descripción	placa de teclado máquina de hielo en cubitos N200/N300/N500		
Para modelos:	N200M, N200MW, N300M, N300MW, N500M		



1

código	401824	referencia	33580123/0 CM33580123/0
descripción	placa electrónica		



1

código	401825	referencia	nicht in Preisliste
descripción	placa electrónica		



1

código	401826	referencia	nicht in Preisliste
descripción	placa electrónica		

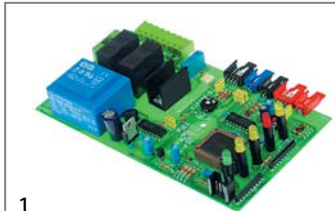

1

código	402034	referencia	62045602
descripción	placa electrónica		



1

código	402815	referencia	33580166/0 CM33580166/0
descripción	placa electrónica abatidor de temperatura apto para ICEMATIC		
Para modelos:	T14, T20, T20C, T20R, T5		

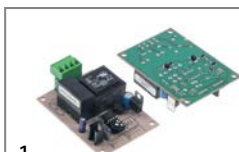

1

código	403499	referencia	33580173 33580173/0 CM33580173/0
descripción	placa electrónica aliment. 230V L 90mm An 60mm para máquina de hielo		
Para modelos:	N401M, N501M		

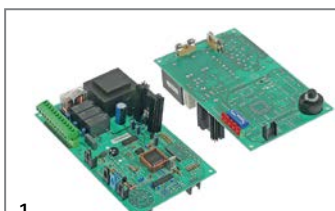

1

código	403021	referencia	33580064/0 CM33580064/0
descripción	placa electrónica apto para Scotsman tipo WSCM0252		

1

código	403548	referencia	33580191/0 CM33580191/0
descripción	placa electrónica L 140mm An 92mm		



1

código	403485	referencia	81400124/0 CM81400124/0
descripción	placa electrónica L 160mm An 95mm aliment. 230V H 45mm		
accesorios para	403485		
	código	referencia	33580265/0 CM33580265/0
	sensor NTC 2kOhm cable PVC sonda -40 a +110°C cable -10 a 100°C empalme conector bulbo ø6x60mm longitud de cable 1.5m		
	código	referencia	33580135/0 CM33580135/0
	sensor NTC 2,2kOhm cable PVC sonda -40 a +110°C cable -10 a 100°C empalme conector rosca bulbo ø5x50mm longitud de cable 2m		



1

código	402035	referencia	33580103/0 CM33580103/0
descripción	placa electrónica L 190mm An 110mm aliment. 230V		



1

código	402003	referencia	CMXP62040316
descripción	placa electrónica máquina de hielo en cubitos AC045/055		



1

código	400055	referencia	CF62047000 CMCF62047000
descripción	placa electrónica máquina de hielo en cubitos ECO 45 230V		



1

código	401799	referencia	33580150/0 33580250/0 CM33580150/0 CM33580250/0
descripción	placa electrónica máquina de hielo en cubitos N201/N301//N501 aliment. 230V		
Para modelos:	N131M, N201M, N301M, N401M, N501M		
accesorios para	401799		
	código	referencia	81455102/0 CM81455102/0
	cable de enlace L 1300mm 2 polos sensor de nivel apto para máquina de hielo en cubitos empalme conector tipo de conector conector codificado		



1

código	403564	referencia	33580166/4 CM33580166/4
descripción	placa electrónica para abatidor de temperatura L 145mm An 120mm apto para ICEMATIC CT1MA0802100 50/60Hz entrada 230V		



1

código	401828	referencia	nicht in Preisliste
descripción	placa electrónica para máquina de hielo con carcasa		



1

código	401833	referencia	nicht in Preisliste
descripción	placa electrónica para máquina de hielo con soporte 24V		



1

código	401823	referencia	33580056/0 CM33580056/0
descripción	placa electrónica para máquina de hielo en cubitos		

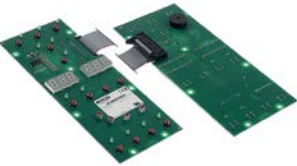

1

código	403454	referencia	33580168/0 CM33580168/0
descripción	platina de control congelador instantáneo T5 apto para ICEMATIC		
Para modelos:	T14, T5		



1

código	403455	referencia	33580167/0 CM33580167/0
descripción	platina suplementaria congelador instantáneo T14 apto para ICEMATIC		
Para modelos:	T14, T20, T20C, T20R, T5		

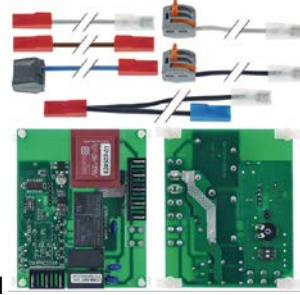

1

código	403687	referencia	CMCS62044100
descripción	temporizador electrónico para máquina de hielo Simag medida de montaje 90x70mm 230		

unidades centrales



1

código	402004	referencia	29070012/0 81469134/0 CM29070012/0 CM81469134/0
descripción	caja electrónica		
Para modelos:	F100, F100C, F120, F125C, F200, F80C, F80WC, SF300, SF500, SFN1000, SFN1000W		
accesorios para	402004		

código	402005	referencia	29070013 29070013/0 620404.10 CF62040410 CM29070013/0 CMCF62040410
---------------	--------	-------------------	---

sensor de temperatura PTC 2kOhm cable TPE sonda -50 a +150°C cable -40 a +110°C empalme conector rosca bulbo ø6x50mm longitud de cable 1.6m

código	402044	referencia	29070015/0 CF62040403 CM29070015/0 CMCF62040403
---------------	--------	-------------------	--

Sensor Hall L 29mm An 26mm H 26mm distancia de sujeción 10mm longitud del cable 1250mm

código	402191	referencia	29070014/0 CF62040401 CM29070014/0 CMCF62040401
---------------	--------	-------------------	--

sensor de temperatura PTC 2kOhm cable TPE sonda -50 a +150°C cable -40 a +110°C empalme conector rosca bulbo ø5x20mm longitud de cable 1.8m



			
1			
código	403028	referencia	62040318 CMXG62040318
descripción	caja electrónica		

			
1			
código	402042	referencia	CMXG06071100
descripción	caja electrónica apto para SFT 012		

			
1			
código	401829	referencia	CF62040409 CMCF62040409
descripción	caja electrónica con carcasa para máquina de hielo		

			
1			
código	401832	referencia	nicht in Preisliste
descripción	caja electrónica con carcasa para máquina de hielo en cubitos 230V		

			
1			
código	403604	referencia	81449089/0 CM81449089/0
descripción	caja electrónica Kit		

			
1			
código	403836	referencia	81414543/0 CF62046213 CF62046215 CM81414543/0 CMCF62046213 CMCF62046215
descripción	caja electrónica máquina de hielo en cubitos para ICEMATIC/SCOTSMAN/SIMAG		

			
1			
código	403837	referencia	81400264/0 CM81400264/0
descripción	caja electrónica máquina de hielo en cubitos para ICEMATIC/SCOTSMAN/SIMAG		

			
1			
código	401841	referencia	nicht in Preisliste
descripción	caja electrónica para máquina de hielo en cubitos 24V 50-60Hz		

			
1			
código	401842	referencia	33580122/0 CM33580122/0
descripción	caja electrónica para máquina de hielo en cubitos 24V 50-60Hz		



teclados

membranas de teclado



1

código	403447	referencia	33489551 33489551/0 CM33489551/0 CM33489553/0
descripción	membrana de teclado abatidor de temperatura ICEMATIC		
Para modelos:	T14, T5		

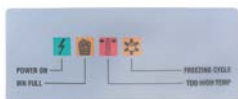

1

código	694118	referencia	nicht in Preisliste enthalten
descripción	membrana de teclado para máquina de hielo en cubitos L 134mm An 52mm		

válvulas magnéticas

válvulas magnéticas agua

ELBI

recto



1

código	370529	referencia	nicht in Preisliste
descripción	válvula magnética simple recto 120VAC entrada 3/4" salida 11,5mm DN10 T máx 60°C ELBI		
repuestos para	370529		
	código	370467	referencia —
filtro de válvula magnética apto para ELBI			



1

código	373000	referencia	19865537/0 CM19865537/0
descripción	válvula magnética simple recto 24V entrada 3/4" salida 11,5mm DN10 T máx 90°C ELBI plástico		
repuestos para	373000		
	código	370467	referencia —
filtro de válvula magnética apto para ELBI			

acodado



1

código	370530	referencia	nicht in Preisliste
descripción	válvula magnética simple acodado 120VAC entrada 3/4" salida 11,5mm reducción entrada A 16l/min DN10 T máx 60°C ELBI plástico		
repuestos para	370530		
	código	370467	referencia —
filtro de válvula magnética apto para ELBI			



1

código	374072	referencia	19863019/0 CM19863019/0
descripción	válvula magnética simple acodado 24VAC entrada 3/4" salida 11,5mm reducción entrada A1/min reducción salida azul		



1

código	374074	referencia	19865507/0 CM19865507/0
descripción	válvula magnética simple recto 220-240VAC entrada 3/4" salida 11,5mm reducción salida rojo		
Para modelos:	N25LBI, N35BI		



1

código	373001	referencia	nicht in Preisliste
descripción	válvula magnética simple recto 230VAC entrada 3/4" salida 11,5mm reducción entrada A/min reducción salida 2l/min 50/60Hz DN10 T máx 90°C ciclo de trabajo 100% ELBI plástico		



1

código	370431	referencia	19865518/0 CM19865518/0
descripción	válvula magnética simple recto 230VAC entrada 3/4" salida 11,5mm reducción entrada A/min reducción salida 2l/min DN10 T máx 90°C ELBI plástico		
Para modelos:	N21S		



1

código	370414	referencia	19865502/0 CM19865502/0
descripción	válvula magnética simple recto 230VAC entrada 3/4" salida 11,5mm reducción salida 2l/min 50/60Hz T máx 90°C ELBI plástico reducción salida blanco		
Para modelos:	N131M, N140, N201M, N20L, N20WL, N25BI, N25L, N25LW, N25S, N25SW, N301M, N35S, N35SW, N401M, N45S, N45SW, N501M, N50BI, N50BIW, N55L, N55LW, N55S, N55SW, N70S, N70SW, N90L, N90LW, N90S, N90SW		



1

código	374073	referencia	19865534/0 CM19865534/0
descripción	válvula magnética simple recto 24VAC entrada 3/4" salida 13,5mm reducción entrada A amarillo		



1

código	370461	referencia	19865509/0 CM19865509/0
descripción	válvula magnética doble recto 230VAC entrada 3/4" salida 11,5mm reducción entrada A/min reducción salida -/4,7l/min DN10 T máx 90°C ELBI plástico reducción salida B 4.7l/min reducción salida B gris salida A sin membrana (siempre abierto)		
Para modelos:	N140, N20L, N20WL, N45S, N45SW, N50BI, N50BIW, N55SW, N70SW, N90LW, N90SW		



1

código	370462	referencia	19865538/0 CM19865538/0
descripción	válvula magnética doble recto 230VAC entrada 3/4" salida 11,5mm reducción entrada A/min reducción salida 0,5/-l/min DN10 plástico reducción salida A 0.5l/min		
Para modelos:	F80C, F80WC, N21S, N45S, N45SW, N55LW		



1

código	370433	referencia	65010551
descripción	válvula magnética doble recto 230VAC entrada 3/4" salida 11,5mm reducción entrada A/min reducción salida 2/2,5l/min DN10 T máx 90°C ELBI plástico reducción salida A 2l/min reducción salida B 2.5l/min reducción salida A blanco reducción salida B naranja		



1

código	370526	referencia	nicht in Preisliste
descripción	válvula magnética doble recto 230VAC entrada 3/4" salida 11,5mm reducción entrada A/min reducción salida 2/2l/min DN10 T máx 60°C ELBI reducción salida A 2 blanco/min reducción salida B 2 blanco/min		



			
1			
código	370499	referencia	nicht in Preisliste
descripción	válvula magnética doble, con reducción recto 230VAC entrada 3/4" salida 11,5mm T máx 60°C reducción salida A 2.5 naranjal/min reducción salida B 2 blanco/min		

ROBERTSHAW/INVENSYS

temperatura líquido: 90°C 90°C 60°C
 temperatura ambiente: 60°C 25°C 60°C
 ciclo de trabajo: 40% 100% 100%

diversos

			
1			
código	371105	referencia	nicht in Preisliste
descripción	válvula magnética acodado 240VAC entrada 3/8" salida 3/8" EATON (INVENSYS) tipo K-63314-12		

			
1			
código	371104	referencia	nicht in Preisliste
descripción	válvula magnética acodado 240VAC entrada 3/8" salida 3/8" SINGER		

			
1			
código	371259	referencia	nicht in Preisliste
descripción	válvula magnética simple acodado 230VAC entrada 11.5 salida 11,5mm DN7 plástico		

			
1			
código	370494	referencia	nicht in Preisliste
descripción	válvula magnética simple acodado 240VAC salida 14,5mm entrada 1/4"mm		

RPE

salida especial

			
1			
código	370453	referencia	19865532/0 19865598/0 CM19865532/0 CM19865598/0
descripción	válvula magnética simple acodado 230VAC entrada 11.5mm salida 11,5mm RPE		
Para modelos:	N131M, N200M, N200MW, N300M, N300MW		

válvulas magnéticas con reducciones

simple

			
1			
código	374075	referencia	400UMIVALV CM400UMIVALV
descripción	válvula magnética simple acodado 230VAC entrada 3/4" salida 10mm reducción entrada A 18,5-20l/min reducción salida 1,0-1,25l/min DN10 RPE reducción salida blanco reducción entrada A blanco		

TP

válvulas magnéticas con reducciones

			
1			
código	370416	referencia	19865530/0 CM19865530/0
descripción	válvula magnética doble recto 230VAC entrada 3/4" reducción entrada A l/min reducción salida 1,2/1,2l/min DN10 T máx 90°C TP plástico salida 11.5mm reducción salida A 1.2l/min reducción salida B 1.2l/min reducción salida A marrón oscuro reducción salida B marrón oscuro		
Para modelos:	N20L, N20WL, N25LW, N25SW, N35SW		



1

código	370422	referencia	nicht in Preisliste enthalten
descripción	válvula magnética doble recto 230VAC entrada 3/4" T máx 90°C TP plástico salida 11.5mm reducción salida A 2.5l/min reducción salida A amarillo reducción salida B marrón		



1

código	370527	referencia	nicht in Preisliste
descripción	válvula magnética simple recto 220-240VAC entrada 3/4" salida 11,5mm reducción salida 0.8l/min TP plástico reducción salida blanco 8VA		

diversos



1

código	370496	referencia	19865525/0 CM19865525/0
descripción	válvula magnética recto 220VAC salida 14mm plástico entrada 14mm		
Para modelos:	N401M, N501M		



1

código	370491	referencia	nicht in Preisliste
descripción	válvula magnética simple 240VAC entrada 3/4" salida 11,5mm		



1

código	370493	referencia	nicht in Preisliste
descripción	válvula magnética simple acodado 24V salida 11,5mm EATON (INVENSYS) plástico entrada 5/8" UNFmm		

metal

PARKER

recambios y accesorios

solenoides



1

código	371098	referencia	CF62030648 CMCF62030648
descripción	bobina magnética 220-230VAC 50/60Hz soporte ø 14mm longitud del cable 1000mm 14W		



1

código	371029	referencia	19053102/0 CM19053102/0	
descripción	bobina magnética PARKER 230VAC 9VA tipo de bobina ZB09 soporte ø 14mm H 33mm An 34mm P 43mm			
Para modelos:	N21S, N25BI			
accesorios para	371029			
	código	371090	referencia	—
	enchufe tipo de conector DIN 43650A atornillado			

válvulas de desagüe



1

código	371106	referencia	nicht in Preisliste
descripción	electroválvula descarga 208/230V simple entrada 17.5mm salida 16mm EATON (INVENSYS) plástico		



válvulas magnéticas refrigeración

ALCO

válvulas

con empalme de tubo



1

código	370492	referencia	nicht in Preisliste
descripción	válvula magnética 24V		



1

código	370535	referencia	nicht in Preisliste
descripción	válvula magnética recto tipo 200RB5T4 230V p máx. 34.5bar empalme 12,7mm conexión para soldadura		



1

código	370534	referencia	nicht in Preisliste
descripción	válvula magnética tipo 200RB3T3 230V tubo ø 9.5mm L 118mm gas caliente		

CASTEL

válvulas



1

código	370403	referencia	19863034/0 CM19863034/0
descripción	válvula magnética NC CASTEL 230V p máx. 45bar empalme 10mm conexión para soldadura -35 a +105°C refrigeración		
Para modelos:	N131M, N200M, N200MW, N201M, N300M, N300MW, N301M, N401M, N500M, N501M		



1

código	370790 ¹	referencia	19863018/0 CM19863018/0 KITVSCOMPO
descripción	electroválvula descarga 24V 50/60Hz entrada 12.5mm salida 15.5mm T máx 40°C CEME latón L 110mm 1/1vías DN 8mm tensión AC tipo de bobina 5704 Kit p máx. 0.2bar p mín. 0bar conector hembra compacto 20°C cuerpo plástico con abrazadera de tubo y tornillos de fijación		

¹con accesorios

1

código	370620	referencia	19865597/0 CM19865597/0
descripción	válvula magnética 220-240V entrada 17.5mm salida 15.5mm EATON (INVENSYS)		



1

código	370691	referencia	19865525 19865597 19865597/0 81454760/0 CM19865597/0 CM81454760/0
descripción	válvula magnética acodado 220-240V Kit entrada 17.5mm salida 16mm		
Para modelos:	N201M, N301M, N500M, N501M		



1

código	370540	referencia	nicht in Preisliste
descripción	válvula magnética acodado 240V 50/60Hz salida 9/16" UNF plástico entrada 9/16" UNF		

cuerpos de válvula

serie STANDARD

apto para refrigerantes R22, R134a, R404A, R407C, R410A, R507

			
código	370382	referencia	19863034/0 19863037/0 CM19863034/0 CM19863037/0
descripción	cuerpo de válvula magnética NC tipo 1028/M10S p máx. 45bar empalme 10mm conexión para soldadura DN 3mm -35 a +105°C L 125mm refrigeración recto CASTEL		
Para modelos:	T14		
accesorios para	370382		
	código	371084	referencia —
	bobina magnética CASTEL 230VAC 8VA 50/60Hz empalme cable 1000mm tipo CM2		
	código	371090	referencia —
	enchufe tipo de conector DIN 43650A atornillado		
	código	371301	referencia —
	bobina magnética CASTEL 110VAC 8VA 50/60Hz soporte ø 11.5mm empalme DIN 43650A tipo HF2		
	código	371314	referencia —
	bobina magnética CASTEL 240VAC 8VA 50/60Hz soporte ø 11.5mm		
	código	371321	referencia —
	bobina magnética CASTEL 12/24VAC 50/60Hz soporte ø 11.5mm empalme DIN 43650A tipo HF2		

PARKER



válvulas

			
código	370415	referencia	19053101/0 19863032/0 19863033/0 19863033/0+19053101/0 CM19053101/0 CM19863032/0 CM19863033/0 CM19863033/0+CM19053101/0
descripción	válvula magnética recto 230V margen de presión 0-10bar DN2,5 empalme 4mm conexión para soldadura PARKER refrigeración		
Para modelos:	N140, N20L, N20WL, N25BI, N25L, N25LBI, N25LW, N25S, N25SW, N35BI, N35S, N35SW, N45L, N45S, N45SW, N55L, N55LW, N55S, N55SW, N70S, N70SW, N90L, N90LW, N90S, N90SW		

			
código	370490	referencia	19870611/0 CM19870611/0
descripción	válvula magnética tipo VE-145 230V 8 refrigeración		

			
código	370495	referencia	19863031/0 CM19863031/0
descripción	válvula magnética tipo VE-145 230V p máx. 10bar margen de presión 0-10bar 8 PARKER recto		

cuerpos de válvula

			
código	370536	referencia	nicht in Preisliste
descripción	cuerpo de válvula magnética p máx. 35bar empalme 3/8" americano PARKER para máquina de hielo tubo ø 10mm gas caliente		
accesorios para	370536		
	código	371098	referencia CF62030648 CMCF62030648
	bobina magnética 220-230VAC 50/60Hz soporte ø 14mm longitud del cable 1000mm 14W		

			
código	370539	referencia	nicht in Preisliste
descripción	cuerpo de válvula magnética recto p máx. 35bar margen de presión 21bar empalme 10mm conexión para soldadura PARKER tubo ø 10mm L 150mm gas caliente		



diversos

cuerpos de válvula



1

código	370429	referencia	CF62030627 CMCF62030627 CMNM62030627
descripción	cuerpo de válvula magnética acodado DN 2.5mm empalme 6mm conexión para soldadura refrigeración		
accesorios para	370429		
	código	371098	referencia CF62030648 CMCF62030648
bobina magnética 220-230VAC 50/60Hz soporte ø 14mm longitud del cable 1000mm 14W			



1

código	370463	referencia	19863041/0 CM19863041/0
descripción	cuerpo de válvula magnética DN 1.6mm empalme 4mm conexión para soldadura refrigeración acodado 90°		
Para modelos:	N21S		



1

código	370424	referencia	CF62030622 CMCF62030622
descripción	cuerpo de válvula magnética DN 1.9mm empalme 6mm conexión para soldadura refrigeración acodado 90°		
Para modelos:	F100C		



1

código	370454	referencia	CMNM62030646
descripción	cuerpo de válvula magnética DN 3mm empalme 6mm conexión para soldadura refrigeración acodado 90°		
accesorios para	370454		
	código	371033	referencia —
bobina magnética PARKER 230VAC 9VA tipo de bobina YB09 mit Kabel soporte ø 14mm			



1

código	370430	referencia	nicht in Preisliste
descripción	cuerpo de válvula magnética empalme 6mm conexión para soldadura refrigeración acodado 90°		



1

código	370458	referencia	nicht in Preisliste
descripción	cuerpo de válvula magnética empalme 6mm conexión para soldadura refrigeración acodado 90°		

Válvulas magnéticas - accesorios

filtros



1

código	371101	referencia	nicht in Preisliste
descripción	filtro de válvula magnética ø 20mm H 17mm apto para ELBI		



1

código	371087	referencia	nicht in Preisliste
descripción	bobina magnética longitud del cable 1100mm soporte ø 6.5mm		



1

código	371108	referencia	nicht in Preisliste
descripción	cuerpo para reductor H 10mm ø 15.7mm		



código	371296	referencia	19190202/0 CM19190202/0
descripción	reducción velocidad de flujo 1.8l/min		

presostatos

para refrigeración

DANFOSS

código	541462	referencia	19550371/0 19550372/0 CM19550371/0 CM19550372/0
descripción	presostato DANFOSS tipo KP5 60-1171 conexión de presión vertical HD refrigeración reinicio automático dif. conmutacion 1,8-6bar margen de presión 8-32bar empalme 7/16" UNF (1/4" SAE)		
Para modelos:	F80C, F80WC, N140, N20L, N20WL, N21S, N25LW, N25SW, N35SW, N45L, N45S, N45SW, N50BI, N50BIW, N55LW, N55S, N55SW, N70S, N70SW, N90S, N90SW		

código	694092	referencia	19550618/0 CM19550618/0
descripción	presostato DANFOSS tipo KP5 60-5133 conexión de presión vertical refrigeración reinicio manual dif. conmutacion 3bar margen de presión 8-32bar empalme 7/16" UNF (1/4" SAE)		
Para modelos:	T20, T20C, T20R		

código	542178	referencia	19550628/0 CM19550628/0
descripción	presostato DANFOSS margen de presión 45bar empalme de presión 6mm conexión para soldadura reinicio baja presión 23.5 margen de trabajo alta presión 32.5bar tipo ACB-2UB178 6A 250V		

código	541626	referencia	19550623/0 CM19550623/0
descripción	presostato dif. conmutacion 30bar reinicio manual empalme de presión 6mm conexión para soldadura 250V longitud del cable 1500mm 1NC 6A		
Para modelos:	T14, T5		

SAGI NO MIYA

código	541610	referencia	81453749/0 CM81453749/0
descripción	presostato p máx. 45bar tipo ACB-2UB135MW presión de paro 30bar presión de encendido 22bar		
Para modelos:	N131M		

JOHNSON CONTROLS

código	541116	referencia	CMXP62007500
descripción	presostato HD presión de conmutación 10bar reinicio automático dif. conmutacion 1.1bar margen de presión 7-29bar p máx. 38bar refrigeración tipo P20EA-9950C empalme conexión para soldadura 6,35mm CO JOHNSON CONTROLS empalme de presión conexión para soldadura 6,35mm		

código	541117	referencia	CMCF62023101 CMCS62023101
descripción	presostato HD presión de conmutación 24bar reinicio manual dif. conmutacion 4.7bar margen de presión 7-29bar p máx. 38bar refrigeración tipo P20GA-9950T empalme conector Faston 6,3mm CO JOHNSON CONTROLS empalme de presión conexión para soldadura 6,35mm		



otros



1

código	542135	referencia	25474402/0 CM25474402/0
descripción	presostato reinicio manual empalme de presión 6mm conexión para soldadura dif. conmutacion 45bar 250V longitud del cable 230mm 1NC 6A		
Para modelos:	N201M, N301M, N401M, N501M		

electródos



1

código	403562	referencia	81455065/0 CM81455065/0
descripción	electrodo de nivel a presión tipo A39030-21 longitud total 120mm sonda L 95mm triple empalme conector Faston 6,3mm inox		

compresores

ACC/ZEL

R134A

HMBP monofásico

Temperatura alta/media de evaporación superior a -20/-15 °C

1

código	605012	referencia	19165497/0 CM19165497/0
descripción	compresor refrigerante R134a tipo GL45TB 220-240V 50Hz HMBP completamente hermético 8.4kg 1/6HP consumo 342W capacidad cilindro 4.5 cm ³ CSIR H 175.5mmW 76W 101W 134W 175W 223W 278W 342W 413W metodo de test ASHRAE temperatura ambiente máx. 43°C		
Para modelos:	N20L, N20WL, N25SW		



1

código	605008	referencia	CM19165851/0
descripción	compresor refrigerante R134a tipo GL80TB 220-240V 50Hz HMBP completamente hermético 9.5kg 1/5HP consumo 554W capacidad cilindro 7.6 cm ³ CSIR H 175.5mm 165W 215W 290W 390W 500W 615W 727W 840W metodo de test ASHRAE temperatura ambiente máx. 43°C		



1

código	605009	referencia	19165548/0 CM19165548/0
descripción	compresor refrigerante R134a tipo GL90TB 220-240V 50Hz HMBP completamente hermético 10.8kg 1/4HP consumo 293W capacidad cilindro 8.8 cm ³ CSIR H 175.5mmW 143W 194W 259W 339W 432W 539W 661W 796W metodo de test ASHRAE		
Para modelos:	F100C, F80C, F80WC, N35BI, N35S, N35SW, N45L, N45S, N45SW		

CUBIGEL

accesorios



1

código	380576	referencia	CF62005731 CMCF62005731
descripción	relé de arranque		
Para modelos:	F100, F120		

1

código	380586	referencia	CM62005732 CMCM62005732
descripción	relé de arranque 120/240V tensión AC 8A 1NO		
Para modelos:	N21S, N25L, N25LBI, N25LW		



1

código	380822	referencia	nicht in Preisliste
descripción	relé de arranque 120/240V tensión AC 8A 1NO		



1

código	380575	referencia	nicht in Preisliste
descripción	relé de arranque MTRP5631		



1

código	605081	referencia	CM19166082/0
descripción	compresor refrigerante R404a/R507 tipo NJ2212GK 220-240V 50Hz LBP completamente hermético 21.5kg 1 1/2HP consumo 1150W capacidad cilindro 34 cm ³ CSR H 277mm 880W 1269W 1738W 2289W 2921W 2921WWWWW metodo de test ASHRAE		



1

código	605164	referencia	CM19166086/0
descripción	compresor refrigerante R404a/R507 tipo NT2178GK 220-240V 50Hz LBP 17kg 1HP capacidad cilindro 17.4 cm ³ CSR H 220mm 442W 610W 808W 1032W 1285W 1565WWWWW		

EMBRACO / ASPERA

R404a/R507

LBP monofásico

Temperatura baja de evaporación inferior a -20°C



1

código	605174	referencia	CM19165559/0
descripción	compresor refrigerante R404a/R507 tipo NJ2192GK 220-240V 50Hz LBP 20.4kg 1 1/4HP capacidad cilindro 26.2 cm ³ CSR H 265mm 685W 989W 1342W 1745W 2196W 2196WWWWW		

HMBP monofásico

Temperatura alta/media de evaporación superior a -20/-15 °C



1

código	605139	referencia	CM19166076/0
descripción	compresor refrigerante R404a/R507 tipo EMT6165GK 220-240V 50Hz HMBP 7.92kg 1/4HP capacidad cilindro 5.19 cm ³ CSIR H 180mmWW 315W 384W 477W 570W 689W 808W metodo de test ASHRAE		



L'UNITE HERMETIQUE / TECUMSEH

R134A

HBP monofásico

Temperatura alta de evaporación superior a -15°C



1

código	605095	referencia	19165556/0 19165643/0 CM19165643/0
descripción	compresor refrigerante R134a tipo AE4450Y-FZ 220-240V 50Hz HBP completamente hermético 11.5kg 3/8HP capacidad cilindro 13.2 cm ³ CSIR H 206mmWWW 526W 672W 843W 1042W 1273W 1540W metodo de test EN 12900		
Para modelos:	N55L, N55LW, N55S, N55SW, N70S, N70SW		



1

código	605184	referencia	CM19165587/0
descripción	compresor refrigerante R134a tipo THB4419YFZ 220-240V 50Hz HBP completamente hermético 7kg 1/6HP consumo 227W capacidad cilindro 5.2 cm ³ CSIR H 228mmWWW 195W 245W 300W 362W 408W 499W temperatura ambiente máx. 32°C		

HMBP monofásico

Temperatura alta/media de evaporación superior a -20/-15 °C



1

código	605173	referencia	CM19165636/0
descripción	compresor refrigerante R134a tipo AE4430Y-FZ1A 220-240V 50Hz HMBP 9.7kg 1/4HP capacidad cilindro 8 cm ³ CSIR H 200mmWW 294W 382W 488W 613W 760W 930W 1127W		



1

código	605098	referencia	19165570/0 CM19165570/0
descripción	compresor refrigerante R134a tipo AE4460Y-FZ 220-240V 50Hz HMBP completamente hermético 12.2kg 1/2HP capacidad cilindro 15.09 cm ³ CSR H 211mmWWW 660W 838W 1040W 1280W 1540W 1840W metodo de test EN 12900		
Para modelos:	N90L, N90LW, N90S, N90SW		



1

código	605137	referencia	19165591/0 CM19165591/0
descripción	compresor refrigerante R134a tipo AEZ4430Y 220-240V 50Hz HMBP completamente hermético 10.2kg 1/4HP consumo 330W capacidad cilindro 8.8 cm ³ CSIR H 199mmWW 245W 328W 432W 558W 698WW		



1



código	605172	referencia	CM19165569/0
descripción	compresor refrigerante R134a tipo CAJ4492Y-F 220-240V 50Hz HMBP 22kg 3/4HP capacidad cilindro 25.95 cm ³ CSIR H 271mmWW 584W 871W 1215W 1617W 2078WW		
repuestos para	605172		
	código	501548	referencia
	caja de conexiones para compresor		

R404A

HMBP monofásico

Temperatura alta/media de evaporación superior a -20/-15 °C

1



código	605158	referencia	CM19165644/0
descripción	compresor refrigerante R404A tipo AE4470Z 220-240V 50Hz HMBP completamente hermético 13.7kg 1/2HP capacidad cilindro 12 cm ³ CSR H 207mmW 670W 843W 1035W 1251W 1495W 1773W 2088W 2447W		

1



código	605027	referencia	CM19165630/0
descripción	compresor refrigerante R404A tipo CAJ4517Z 220-240V 50Hz HMBP completamente hermético 24kg 1.2HP capacidad cilindro 25.95 cm ³ CSR H 282mmWW 1588W 1987W 2451W 2971W 3536W 4132W metodo de test EN 12900 4742W		

1



código	605065	referencia	81453661 81453661/0 CF67009905 CM19165594/0 CM81453661/0 CMCF67009905
descripción	compresor refrigerante R404A tipo CAJ4519Z 220-240V 50Hz HMBP 24kg 1.5HP capacidad cilindro 34.4 cm ³ CSR H 282mmWWW 1769W 2353W 3009W 3756W 4360W 5200W		
Para modelos:	N301M, SF500		

1



código	605026	referencia	CM19165632/0
descripción	compresor refrigerante R404A tipo CAJ9480Z 220-240V 50Hz HMBP completamente hermético 22kg 3/4HP capacidad cilindro 15.2 cm ³ CSR H 271mm 393W 571W 774W 1009W 1284W 1607W 1989W 2334W metodo de test EN 12900 2699W		

1



código	605032	referencia	CM19165554/0 CM19165596/0
descripción	compresor refrigerante R404A tipo CAJ9510Z 220-240V 50Hz HMBP completamente hermético 23kg 1HP capacidad cilindro 18.3 cm ³ CSR H 282mm 527W 732W 970W 1252W 1583W 1972W 2437W 2826W metodo de test EN 12900 3220W		



1

código	605070	referencia	CM19165631/0
descripción	compresor refrigerante R404A tipo CAJ9513Z 220-240V 50Hz HMBP completamente hermético 23kg 1.1HP capacidad cilindro 24.2 cm ³ CSR H 282mmW 930W 1269W 1654W 2086W 2568W 3096W 3671W metodo de test EN 12900 4278W		

accesorios

relé de arranque

Klixons



1

código	380582	referencia	nicht in Preisliste
descripción	relé de arranque Klixon 131 15A serie 9660B		



1

código	380583	referencia	nicht in Preisliste
descripción	relé de arranque Klixon 145 serie 9660B		



1

código	380856	referencia	nicht in Preisliste
descripción	relé de arranque Klixon 170 15A serie 9660A		

RBM



1

código	380595	referencia	nicht in Preisliste
descripción	relé de arranque RBM 128306-1645PB		



1

código	380594	referencia	nicht in Preisliste
descripción	relé de arranque RBM 128306-1653VB		

otros



1

código	380587	referencia	nicht in Preisliste
descripción	relé de arranque 230V 1NC empalme conector Faston 6,3mm		



1

código	380581	referencia	nicht in Preisliste
descripción	relé de arranque 230V 1NO/1NC empalme conector Faston 6,3mm con lengüeta medidas 45x50x42mm		

interrupor térmico (klixon)



1

código	390654	referencia	nicht in Preisliste
descripción	interrupor térmico		



1

código	390640	referencia	CF62005878 CMCF62005878
descripción	interrupor térmico para protección de motor térmica con cable reinicio automático		
Para modelos:	SF300		



1

código	390651	referencia	nicht in Preisliste
descripción	interrupor térmico para protección de motor térmica MRA38031-3007 con cable T máx 145°C reinicio automático		



1

código	390544	referencia	nicht in Preisliste
descripción	interruptor térmico para protección de motor térmica T0168/22 con cable T máx 150°C reinicio automático		



1



código	390608	referencia	nicht in Preisliste
descripción	interruptor térmico para protección de motor térmica T0418/A4		



1

código	390666	referencia	nicht in Preisliste
descripción	interruptor térmico para protección de motor térmica L140-20F 8926 longitud del cable 90mm		

repuestos para 601427

código	560332	referencia	—
	arandela int.ø 4.3mm ø ext. 9mm espesor 0.8mm inox UE 1 pzs		
código	560340	referencia	—
	tuerca hexagonal rosca M4 H 3.2mm EC 7 inox DIN/ISO DIN 934 / ISO 4032/8673 UE 1 pzs		
código	601413	referencia	—
	placa de sujeción apto para rodete ventilador ø ext. 32mm eje ø 7 distancia de sujeción 26mm		



1

código	601528	referencia	CF62041904 CMCF62041904
descripción	motor de ventilador ELCO 16W 230V 50/60Hz cojinete cojinete de fricción L1 48mm L2 64mm L3 91.5mm An 83mm empalme cable 500mm 1300/1550rev/min 5 opciones de montaje VNT16-25/029		
Para modelos:	SF300		
repuestos para	601528		
	código	601413	referencia —
	placa de sujeción apto para rodete ventilador ø ext. 32mm eje ø 7 distancia de sujeción 26mm		

ventiladores

ventiladores para frigoríficos

motores refrigeración universales

ELCO

serie N - multianclaje



1

código	601427	referencia	18562496/0 29020001 29020003 CF62041902 CM18562496/0 CMCF62041902
descripción	motor de ventilador ELCO 10W 230V 50/60Hz cojinete cojinete de fricción L1 49mm L2 59mm L3 86.5mm An 83mm empalme cable 500mm 1300/1550rev/min 5 opciones de montaje VNT10-20/028		
Para modelos:	F100, F100C, F120, F200, N35S, N35SW, N45L		
repuestos para	601427		
	código	560140	referencia —
	tuerca hexagonal rosca M4 H 4.8mm inox EC 7 UE 20 pzs DIN/ISO DIN 985 autobloqueo		



1

código	601530	referencia	29020005
descripción	motor de ventilador ELCO 34W 230V 50/60Hz cojinete cojinete de fricción L1 55.5mm L2 91.5mm L3 119mm An 83mm empalme cable 500mm 1300/1550rev/min 5 opciones de montaje VNT34-45/031		
repuestos para	601530		
	código	601413	referencia —
	placa de sujeción apto para rodete ventilador ø ext. 32mm eje ø 7 distancia de sujeción 26mm		



serie N - estándar



código	601527	referencia	18562058/0 CM18562058/0
descripción	motor de ventilador 16W 230V 50/60Hz An 84mm 1300rev/min VN16-38		
Para modelos:	N200M, N200MW, N300M, N300MW		



código	601545	referencia	I-1013
descripción	motor de ventilador 7W 220-240V 50-60Hz L3 101mm An 85mm		
repuestos para	601545		
	código	601413	referencia —
	placa de sujeción apto para rodete ventilador ø ext. 32mm eje ø 7 distancia de sujeción 26mm		

otros



código	601431	referencia	29020005 CF62041906 CMCF62041906
descripción	motor de ventilador 35W 230V		
Para modelos:	SF500		

accesorios

rodetes de ventilador

aluminio

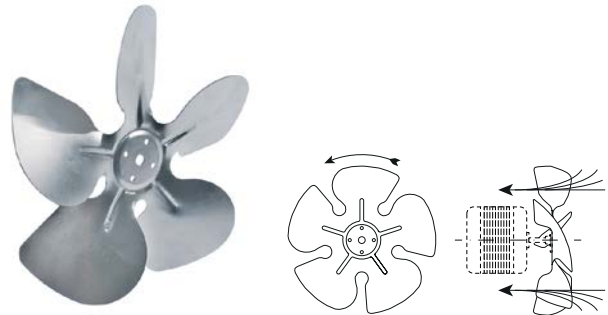

código	601282	referencia	18740031/0 CM18740031/0
descripción	rodete ventilador aspirante ø 200mm fijación asta 25.4mm inclinación de la pala 34° An 44mm aluminio		



código	601524	referencia	18562524 18562524/0 CM18562524/0
descripción	motor de ventilador 35W 230V 50/60Hz L3 153mm An 83mm longitud del cable 1600mm 1300rev/min con condensador condensador 2.5µF		
Para modelos:	N131M, N201M, N301M, N401M, N501M		

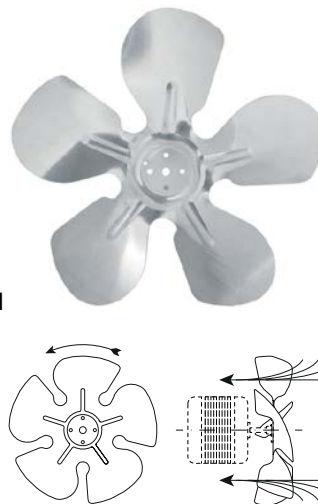

código	601387	referencia	62041934
descripción	rodete ventilador aspirante ø 254mm fijación asta 25.4mm inclinación de la pala 34° An 50mm aluminio		

1

código	601555	referencia	CF6200001 CF62041936 CMCF6200001 CMCF62041936
descripción	rodete ventilador aspirante ø 300mm fijación asta 25.4mm inclinación de la pala 25° An 45mm aluminio		
Para modelos:	SF500		

1

código	602041	referencia	18740042/0 CM18740042/0
descripción	rodete ventilador soplado ø 300mm fijación asta 25.4mm inclinación de la pala 31° An 58mm aluminio		

1

código	601410	referencia	18740032/0 CM18740032/0
descripción	rodete ventilador aspirante ø 300mm fijación asta 25.4mm inclinación de la pala 28° An 45mm aluminio		
Para modelos:	N401M, N501M		

motores de refrigeración completos

1

código	601526	referencia	18562065/0 CM18562065/0
descripción	ventilador 230V 10W 50Hz rodete ventilador ø 200mm eje L 13mm L 76mm An 83mm empalme cable longitud del cable 500mm		
Para modelos:	N500M		
repuestos para	601526		
	código	601070	referencia —
	rodete ventilador aspirante ø 200mm fijación asta 25.4mm inclinación de la pala 28° An 38mm aluminio		

aluminio

1

código	601556	referencia	18740040/0 CM18740040/0
descripción	rodete ventilador soplado ø 254mm fijación asta 25.4mm inclinación de la pala 31° An 46mm aluminio		

1

código	601557	referencia	I-160
descripción	ventilador 230V 5W 50-60Hz rodete ventilador ø 200mm altura de pies 60mm L 83mm An 92mm H 66mm inclinación de la pala 28° empalme con cable distancia de sujeción 75mm		
Para modelos:	N1, N1W, N2, N2W, N3, N35, N3W, N4, N5		



1

código	694178	referencia	18562517/0 CM18562517/0
descripción	ventilador 220-240V 16W 50-60Hz rodete ventilador ø 250mm empalme con cable distancia de sujeción 300mm		
Para modelos:	N140, T5		

HIDRIA

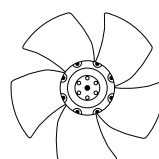
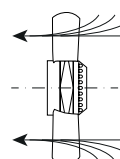
1

código	602029	referencia	18562559/2 CM18562559/2 CM18562559/3
descripción	ventilador tipo R09R-30SPB-4M-3509 rodete ventilador ø 300mm 230V 50/60Hz 80W ø 105mm condensador apropiado 2.5µF HIDRIA apto para abatidor de temperatura 1370rev/min H 90mm longitud del cable 1800mm distancia de sujeción 255mm		

ventiladores de refrigeración

ebm-papst

serie A4E

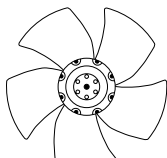
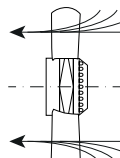
1

código	602026	referencia	18562532/0 CM18562532/0
descripción	ventilador A4E300-AA01-57 rodete ventilador ø 300mm palas 5 230V 50/60Hz 95/105W 1350/1450rev/min longitud del cable 2030mm ebm-papst aspirante condensador apropiado 3µF		
Para modelos:	T14, T20, T20C, T20R, T5		
repuestos para	602026		
	código	365137	referencia —
	condensador capacidad 3µF 450V tolerancia 5% 50/60Hz temperatura ambiente máx. -25 a + 85°C ø 25mm L 56mm M8 plástico empalme cable 250mm 416.17.77GF protección		

1

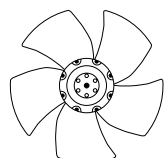
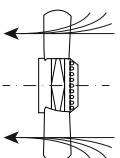
código	602009	referencia	18562519/0 CM18562519/0
descripción	ventilador tipo R09R-3530HA-4M-4237 rodete ventilador ø 350mm 230V 50/60Hz 130/165W HIDRIA 1290/1380rev/min aspirante H 155mm longitud del cable mm distancia de sujeción 315mm		
Para modelos:	T14, T20, T20C, T20R		

COPREL

serie MAP





1

código	601039	referencia	185602055
descripción	ventilador aspirante 230V 9W 50/60Hz rodete ventilador ø 96mm eje L 20mm empalme con cable para saladette		

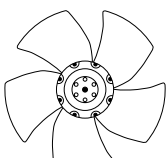
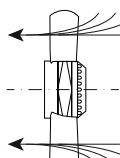
1

código	602024	referencia	18562576/0 CM18562576/0
descripción	ventilador A4E300-AS72-07 rodete ventilador ø 300mm palas 5 230V 50/60Hz 72/90W 1320/1500rev/min longitud del cable 2030mm ebm-papst aspirante condensador apropiado 2µF		
repuestos para	602024		
	código	365170	referencia —
	condensador capacidad 2µF 425V tolerancia 5% 50/60Hz temperatura ambiente máx. -25 a + 85°C ø 25mm L 49mm M8 plástico empalme cable 250mm 416.17.74 protección		

ventiladores de refrigeración varios

EURO MOTORS ITALIA



1

código	601554	referencia	29020006/0 CF62027300 CM29020006/0 CMCF62027300
descripción	motor de ventilador 230V 50-60Hz 100W An 105mm H 105mm P 220mm eje L 80mm eje ø 12mm EURO MOTORS tipo 10111-40100 longitud del cable 1500mm 1100rev/min		
Para modelos:	SFN1000, SFN1000W		

ventiladores de refrigeración



1

código	602025	referencia	18562012/0 CM18562012/0
descripción	ventilador 230V 50Hz 27.5W An 110mm H 125mm P 110mm Emmevi tipo 202001		

ventiladores radiales

otros



1

código	601523	referencia	18562480/0 CM18562480/0
descripción	ventilador radial 230V tensión AC 50Hz 50W H1 175mm L1 165mm D1 ø 83mm B1 160mm B2 73mm H2 60mm B3 82mm H3 96mm		
Para modelos:	N50BI, N50BIW		

motores

motorreductores

para máquina de hielo en cubitos

para paleta



1

código	500407	referencia	19440059/0 19440059/1 CM19440059/0 CM19440059/1
descripción	motorreductor LIP tipo 123MR 8W 220/240V tensión AC 50/60Hz 50rev/min sentido de rotación en sentido anti-horario eje ø 4mm soporte de eje ø 6.2mm ancho de ranura 2.3mm eje L 8mm árbol ø 4mm An 74mm		
Para modelos:	N140, N20L, N20WL, N25BI, N25L, N25LBI, N25LW, N25S, N25SW, N35BI, N35S, N35SW, N45L, N45S, N45SW, N50BI, N50BIW, N55L, N55LW, N55S, N55SW, N70S, N70SW, N90L, N90LW, N90S, N90SW		

para cubetas



1

código	500410	referencia	19440065/0 CM19440065/0
descripción	motor de cubeta LIP 11W 230V 50Hz 0.7rev/min árbol ø 7mm longitud árbol 20mm An 72mm H 110mm 010		
Para modelos:	N140, N70S, N70SW, N90L, N90LW, N90S, N90SW		



1

código	500786	referencia	81404024/0 CM81404024/0
descripción	motor de cubeta LIP 11W 230V 50Hz 1rev/min árbol ø 8mm An 100mm H 90mm para máquina de hielo L 130mm		
Para modelos:	N20L, N20WL, N25BI, N25L, N25LBI, N25LW, N25S, N25SW, N35BI, N35S, N35SW, N45L		
repuestos para	500786		
	código	referencia	25260000/0 CM25260000/0
arandela para basculación cuba ø 100mm soporte de eje ø 7mm			



1

código	500409	referencia	19440058 19440063/0 19440069/0 81404001/0 CM19440063/0 CM19440069/0 CM81404001/0
descripción	motor de cubeta LIP tipo 001 11W 220/240V tensión 50/60 0.7rev/min árbol ø 7mm longitud árbol 20mm An 71mm H 62mm L 110mm		



1

código	500411	referencia	19440057/0 CM19440057/0
descripción	motorreductor BITRON tipo 97103 11W 230V 50Hz 0.7rev/min árbol ø 7mm longitud árbol 30mm An 72mm H 60mm L 116mm		



1

código	500412	referencia	19440073/0 CM19440073/0
descripción	motorreductor LIP tipo 021B 11W 230V 50Hz 1rev/min árbol ø 7mm longitud árbol 20mm An 74mm P 67mm H 110mm para cubeta		



1

código	499089	referencia	81413011/0 CM81413011/0
descripción	motorreductor LIP tipo 10 11W 220/240V 50/60Hz 0.7rev/min árbol ø 8mm para máquina de hielo		



1

código	500756	referencia	81442072/0 CM81442072/0
descripción	motorreductor LIP tipo 10 11W 220/240V tensión AC 50/60Hz 0.7rev/min árbol ø 8mm An 118mm H 88mm para máquina de hielo L 130mm		
Para modelos:	N140		



1

código	501480	referencia	81400006/0 CM81400006/0
descripción	motorreductor tipo ST0676 11W 220/240V tensión AC 50/60Hz 1rev/min árbol ø 8mm An 80mm P 93mm H 112mm para máquina de hielo		

otros



1

código	601539	referencia	81401520/0 CM81401520/0
descripción	motorreductor LIP tipo 049E 80W 230V 50Hz 13rev/min árbol ø 18mm L 160mm An 74mm H 160mm para esparrago		

 <p>1</p>			
código	499077	referencia	29030005/0 79422513 79422513R CF79422513 CF79422513R CM29030005/0 CMCF79422513 CMCF79422513R
descripción	motorreductor tipo 794225 220V tensión AC 50/60Hz árbol ø 22.2mm L 260mm An 150mm H 245mm para máquina de hielo 120W		
Para modelos:	F100, F100C, F120, F125C, F200, F80C, F80WC		

motores

para máquina de hielo en cubitos

rotores

 <p>1</p>			
código	500751	referencia	nicht in Preislisten enthalten
descripción	rotor ø 65mm árbol ø 13mm longitud árbol 180mm para fabricante de hielo en escamas		

estatores

 <p>1</p>			
código	695826	referencia	29000010/0 CF62029500 CM29000010/0 CMCF62029500
descripción	estátor 230V 50/60Hz fases 1 ø 135mm int.ø 80mm H 45mm con carcasa		
Para modelos:	SF300, SF500, SFN1000, SFN1000W		

bombas

bombas de salida

HANNING

 <p>1</p>			
código	500757	referencia	95005643/0 CM95005643/0
descripción	bomba de desagüe entrada ø 18mm salida ø 20mm 230V 50Hz HANNING		

otros

 <p>1</p>			
código	501490	referencia	CMUMPOMPA943
descripción	bomba de desagüe entrada ø 24mm salida ø 24mm		

bombas para máquinas de cubitos de

 <p>1</p>			
código	501491	referencia	18562001/0 CM18562001/0
descripción	bomba 230V 50/60Hz empalme cable TRIAL L 218mm An 60mm H 60mm árbol ø 6mm longitud árbol 155mm		



1

código	500759	referencia	nicht in Preisliste enthalten
descripción	bomba GRE 30W 230V 60Hz salida ø 12.5mm L 137mm dirección de rodadura derecho para máquina de hielo		



1

código	500597	referencia	19550109 19550109/0 CM19550109/0 CMXG62043003
descripción	bomba GRE tipo MH50F 60W 230V 50Hz salida ø 21mm L 110mm dirección de rodadura derecho para máquina de hielo		



1

código	500763	referencia	nicht in Preisliste
descripción	bomba HARTELL tipo U21B 25W 230V 50/60Hz salida ø 19mm L 120mm para máquina de hielo 0.33HP condensador 12.5µF		



1

código	499005	referencia	nicht in Preisliste
descripción	bomba HARTELL tipo U21B 75W 240V 50/60Hz salida ø 12mm L 120mm para máquina de hielo		



1

código	500047	referencia	19550113/0 CM19550113/0 CMCS62043300 CMNM62043300 CMXG62043300
descripción	bomba REBO tipo MH30F1 30W 230V 50Hz salida ø 12.7mm L 135mm dirección de rodadura izquierdo		
Para modelos:	N131M, N201M, N21S, N301M, N401M, N501M		



1

código	500761	referencia	19535157 19535157/0 CM19535157/0
descripción	bomba REBO tipo MH30F1 30W 230V 50Hz salida ø 13mm L 135mm dirección de rodadura derecho para máquina de hielo		
Para modelos:	N200M, N200MW, N300M, N300MW		



1

código	500754	referencia	19580001/0 CM19580001/0
descripción	bomba REBO tipo MH50F 50W 230V 50Hz salida ø 18mm L 135mm para máquina de hielo		
Para modelos:	N500M		



1

código	500048	referencia	19550112/0 CM19550112/0
descripción	bomba REBO tipo MH50F 60W 230V 50Hz salida ø 18mm L 137mm dirección de rodadura derecho para máquina de hielo		



1

código	500203	referencia	67000212 nicht in Preisliste
descripción	bomba REBO tipo MH50F 60W 230V 50Hz salida ø 21mm L 110mm dirección de rodadura derecho para máquina de hielo		



1

código	501481	referencia	81452001/0 CM81452001/0
descripción	bomba REBO tipo NR40 40W 220/240V 50Hz salida ø 12.7mm L 275mm dirección de rodadura izquierdo		



1

código	500046	referencia	nicht in Preisliste
descripción	bomba REBO tipo NR40 40W 230V 50Hz entrada ø 12mm salida ø 12mm L 75mm dirección de rodadura derecho para máquina de hielo en cubitos		



1

código	500781	referencia	I-1029
descripción	motor de ventilador 11W 230V 50-60Hz L 83mm An 83mm H 75mm árbol ø 7mm		

bombas para expendedoras de bebidas

motores de bomba



1

código	500781	referencia	I-1029
descripción	motor de ventilador 11W 230V 50-60Hz L 83mm An 83mm H 75mm árbol ø 7mm		

condensadores y filtros antiparasitarios

condensadores de arranque



1

código	365102	referencia	19180567/0 CM19180567/0
descripción	condensador de arranque 330V 50Hz con resistencia ciclo de trabajo 3/1,7% capacidad 88µF		



1

código	365094	referencia	nicht in Preisliste
descripción	condensador de arranque 330V capacidad 64µF		



1

código	365101	referencia	nicht in Preisliste
descripción	condensador de arranque 330V ciclo de trabajo 1.7% capacidad 125µF		



1

código	365096	referencia	nicht in Preisliste
descripción	condensador de arranque 88µF 330V		



1

código	365095	referencia	CF62016729 old CMCF62016729 old
descripción	condensador de arranque 43µF 330V 50/60Hz ciclo de trabajo 3 60A1D330043NXET ø 36mm L 80mm M8 plástico empalme cable 350mm 04P.5523CM		



			
1			
código	365153	referencia	CF62016729 CMCF62016729
descripción	condensador de arranque 52µF 330V 50/60Hz ciclo de trabajo 3s 41280A133 2252347 ø 36mm L 83mm M8 plástico empalme cable 350mm		
Para modelos:	F100, F120		

condensadores de arranque electrolíticos

			
1			
código	365098	referencia	nicht in Preisliste
descripción	condensador de arranque 320V 50/60Hz electrolítico capacidad 125µF		

condensadores de servicio

plástico

			
1			
código	365031	referencia	29015023/0 CF62029204 CM29015023/0 CMCF62029204
descripción	condensador de servicio capacidad 4µF 450V tolerancia 5% 50/60Hz temperatura ambiente máx. -25 a +85°C ø 31mm L 58mm M8 plástico empalme conector Faston 6,3mm protección		
Para modelos:	F100, F120, F125C, F200, F80C, F80WC		

metal

			
1			
código	365204	referencia	19180501/0 CM19180501/0
descripción	condensador de servicio capacidad 15µF 400V tolerancia 10% 50-60Hz temperatura ambiente máx. -40 a +85°C ø 35mm L 135mm M8 aluminio empalme cable 630mm		

			
1			
código	365099	referencia	nicht in Preisliste
descripción	condensador de servicio capacidad 15µF 440V con revestimiento metálico		

			
1			
código	365097	referencia	19180593/0 CM19180593/0
descripción	condensador de servicio capacidad 35µF 450V con revestimiento metálico 50/60Hz		
Para modelos:	N301M		

fusibles

fusibles finos

			
1			
código	358509	referencia	CMXP63001511
descripción	fusible fino medida ø5x20mm 0.05A retardado nominal 250V UE 1 pzs		

accesorios eléctricos

cables

cables de cinta plana

grupo 1

			
1			
código	403565	referencia	33580172/0 CM33580172/0
descripción	cable de cinta plana 26 polos L 1000mm		
Para modelos:	T14, T20, T20C, T20R, T5		

grupo 7

			
1			
código	694212	referencia	29015064/0 CM29015064/0
descripción	cable de cinta plana 3 polos L 150mm para test		



1 			
código	401818	referencia	nicht in Preisliste
descripción	cable de cinta plana 4 polos L 1000mm		

mazos de cables			
1 			
código	551435	referencia	81414570/0
descripción	mazo de cables para 360665		

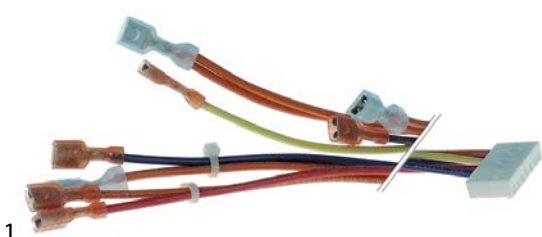
cables de enlace			
1 			
código	401796	referencia	nicht in Preisliste
descripción	cable de conexión L 690mm empalme conector Faston 6,3mm		

1 			
código	701450	referencia	81455102/0 CM81455102/0
descripción	cable de enlace L 1300mm 2 polos sensor de nivel apto para máquina de hielo en cubitos empalme conector tipo de conector conector codificado		

terminales de cable y conectores			
sin aislar			
fundas protectoras			
1 			
código	358002	referencia	nicht in Preisliste
descripción	funda protectora tamaño 6.3mm para faston macho plástico		

componentes electrónicos

fotocélulas

1 			
código	541611	referencia	33580092/0 CM33580092/0
descripción	fotocélula derecho cuadrado empalme azul L 40mm An 25mm H 40mm para máquina de hielo		

1 			
código	541608	referencia	33580091/0 CM33580091/0
descripción	fotocélula izquierdo cuadrado empalme negro L 40mm An 25mm H 40mm para máquina de hielo		

componentes específicos

para frigoríficos

cajas y paneles frontales

manillas			
1 			
código	692590	referencia	26116360/0 CM26116360/0
descripción	barra de asidero L 265mm An 16mm H 5.6mm parte interior inox UE 1 pzs		

otros			
1 			
código	694822	referencia	26104013/0 CM26104013/0
descripción	barra guía pos. de montaje derecho L 400mm An 45mm		

			
1			
código	694821	referencia	26104012/0 CM26104012/0
descripción	barra guía pos. de montaje izquierdo L 400mm An 45mm		

 <p>imagen no disponible</p>			
1			
código	695802	referencia	81502101/0 CM81502101/0
descripción	cubeta para frigorífico An 585mm H 150mm P 440mm acero inoxidable		

para máquina de hielo en cubitos

sistemas de desagüe

piletas de desagüe

			
1			
código	696583	referencia	25685310/0 25685311/0 25685313/0 CM25685310/0 CM25685311/0 CM25685313/0
descripción	pileta de desagüe ø 50mm rosca 3/4 tubo ø 21mm L 55mm recto para máquina de hielo en cubitos		

cubetas de desagüe

			
1			
código	696616	referencia	25820129/0 CM25820129/0
descripción	cubeta de desagüe L 160mm An 55mm H 200mm plástico		

filtros			
			
1			
código	695769	referencia	25339002/0 CM25339002/0 CMNX66021101 CMXG66021101
descripción	filtro de desagüe rosca 7/8" ø 32mm H 10mm		

tubos de rebose			
			
1			
código	695735	referencia	25780153/0 CM25780153/0
descripción	tubo flexible de PVC int.ø 10mm ø ext. 14mm L 165mm biselado		
Para modelos:	N20L, N20WL, N25BI, N25S, N25SW		

rompes hielo			
			
1			
código	695629	referencia	CF75400102 CMCF75400102
descripción	rompe hielo int.ø 26mm ø ext. 51mm H 59mm latón		
Para modelos:	F100, F100C, F120, F125C, F200, F80C, F80WC		

			
1			
código	696436	referencia	29015001 29060000 CF06072000 CMCF06072000
descripción	rompe hielo int.ø 26mm ø ext. 51mm H 59mm latón con rodamiento de bolas		

			
1			
código	694788	referencia	CF00102807 CMCF00102807
descripción	rompe hielo int.ø 26mm ø ext. 51mm H 59mm latón con rodamiento de bolas y junta de árbol		
Para modelos:	F100, F120, F125C, F200, F80C, F80WC		

conductos hielo

conductos hielo



1

código	694193	referencia	81480086/0 CM81480086/0
descripción	conducto hielo para evaporador L 170mm An 100mm H 160mm acero inoxidable		
Para modelos:	SF300, SF500		



1

código	694282	referencia	25260472/0 25260473/0 CM25260472/0 CM25260473/0
descripción	conducto hielo para máquina de hielo en cubitos L 210mm An 365mm H 90mm blanco		
Para modelos:	F80C, F80WC, N25L, N25LBI, N25LW, N35BI, N35S, N35SW, N45L, N45S, N45SW, N50BI, N50BIW, N55L, N55LW, N55S, N55SW		



1

código	694915	referencia	25250186/0 CM25250186/0
descripción	conducto hielo para máquina de hielo L 255mm An 205mm H 85mm plástico		



1

código	694790	referencia	25250185/0 CM25250185/0
descripción	conducto hielo para máquina de hielo L 320mm An 205mm H 85mm plástico blanco		



1

código	694792	referencia	25250187/0 CM25250187/0
descripción	conducto hielo para máquina de hielo L 370mm An 205mm H 85mm plástico blanco		



1

código	695179	referencia	25260459/0 CM25260459/0
descripción	conducto hielo para máquina de hielo L 530mm An 200mm H 150mm		



1

código	695595	referencia	25250099/0 25260462/0 CM25250099/0 CM25260462/0
descripción	conducto hielo para puerta L 345mm An 205mm blanco		
Para modelos:	N20L, N20WL, N25BI, N25S, N25SW		



1

código	695596	referencia	25250106/0 CM25250106/0
descripción	conducto hielo para puerta L 423mm An 205mm		



2

código	695665	referencia	25260470/0 25260471/0 CM25260470/0 CM25260471/0
descripción	parte interior de puerta para máquina de hielo L 595mm An 210mm H 95mm blanco		
Para modelos:	F100C, F125C, N70S, N70SW, N90L, N90LW, N90S, N90SW		

mallas antideslizantes



1

código	696384	referencia	81403045/0 CM81403045/0
descripción	malla antideslizante para máquina de hielo en cubitos L 195mm An 114mm H 83mm		
Para modelos:	N20L, N20WL, N25BI, N25S, N25SW		



1

código	694145	referencia	19680501/0 CM19680501/0
descripción	malla antideslizante para máquina de hielo en cubitos L 250mm An 170mm H 25mm		
Para modelos:	N21S		



1

código	695684	referencia	25700405/0 81403025/0 CM25700401/0 CM25700405/0 CM81403025/0
descripción	malla antideslizante para máquina de hielo L 170mm An 150mm		
Para modelos:	N35BI, N35S, N35SW		



1

código	695686	referencia	81413031/0 CM81413031/0
descripción	malla antideslizante para máquina de hielo L 170mm An 260mm		
Para modelos:	N45L, N45S, N45SW, N50BI, N50BIW, N55L, N55LW, N55S, N55SW		



1

código	695687	referencia	81423063/0 CM81423063/0
descripción	malla antideslizante para máquina de hielo L 170mm An 440mm		
Para modelos:	N70S, N70SW, N90L, N90LW, N90S, N90SW		

palas de hielo



1

código	694819	referencia	19500099/0 CM19500099/0
descripción	pala de hielo L 155mm An 80mm H 55mm		



1

código	694820	referencia	19500101/0 CM19500101/0
descripción	pala de hielo L 240mm An 150mm H 90mm		



1

código	691802	referencia	19500102/0 CM19500102/0
descripción	pala de hielo L 240mm An 150mm H 92mm		
Para modelos:	N131M, N200M, N200MW, N201M, N300M, N300MW, N301M, N401M, N501M		



1

código	692591	referencia	19500100/0 CM19500100/0
descripción	pala de hielo medio L 220mm An 112mm H 70mm plástico UE 1		
Para modelos:	F100C, F125C, F80C, F80WC, N140, N20L, N20WL, N25L, N25LW, N25S, N25SW, N35S, N35SW, N45L, N45S, N45SW, N50BI, N50BIW, N55L, N55LW, N55S, N55SW, N70S, N70SW, N90L, N90LW, N90S, N90SW		

recambios y accesorios



1

código	695020	referencia	25654016/0 CM25654016/0
descripción	arandela para basculación cuba		
Para modelos:	N140, N20L, N20WL, N25S, N25SW, N45S, N45SW, N50BI, N50BIW, N55L, N55LW, N55S, N55SW, N70S, N70SW		

sensores

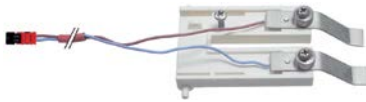

1

código	401764	referencia	81453007 81453114/0 81453434/0 CM81453114/0 CM81453434/0
descripción	sensor para espesor hielo		
Para modelos:	N131M, N200M, N200MW, N201M, N300M, N300MW, N301M, N401M, N500M, N501M		



1

código	401800	referencia	81453860/0 CM81453860/0
descripción	sensor para espesor hielo		



1

código	695707	referencia	81453782/0 CM81453782/0
descripción	sensor para espesor hielo		

			
1			
código	696613	referencia	81455094/0 CM81455094/0
descripción	sensor para máquina de hielo		

			
1			
código	698720	referencia	81400044/0 CM81400044/0
descripción	sensor para máquina de hielo 1 polos longitud del cable 350mm		

			
1			
código	401837	referencia	81453796/0 CM81453796/0
descripción	sensor para nivel de agua 2 polos longitud del cable 85mm		
Para modelos:	N401M, N501M		

			
1			
código	694555	referencia	25725450/0 CM25725450/0
descripción	soporte para sonda L 60mm An 56mm H 18mm chapa de acero tincado espesor 1mm		
Para modelos:	N131M, N200M, N200MW, N201M, N300M, N300MW, N301M, N401M, N500M, N501M		

sistemas rociadores

ICEMATIC

brazos rociadores

			
1			
código	695705	referencia	25791456/0 CM25791456/0
descripción	brazo rociador L 240mm boquillas 6 para máquina de hielo		
Para modelos:	N21S		

			
1			
código	694793	referencia	81453460/0 CM81453460/0
descripción	brazo rociador L 335mm boquillas 15 para máquina de hielo		
Para modelos:	N131M		

			
1			
código	694313	referencia	81453009/0 81453575/0 CM81453009/0 CM81453575/0
descripción	brazo rociador L 490mm boquillas 18 para máquina de hielo		
Para modelos:	N200M, N200MW, N201M, N300M, N300MW, N301M, N401M, N500M, N501M		

accesorios

			
1			
código	695714	referencia	25799001/0 CM25799001/0
descripción	boquilla para máquina de hielo		
Para modelos:	N21S		

			
1			
código	695068	referencia	25728011/0 CM25728011/0
descripción	tapa terminal para máquina de hielo agujero inserto 13x13mm		
Para modelos:	N21S		

puertas

casquillos

			
1			
código	695883	referencia	25110114/0 CM25110114/0
descripción	anillo distnciador para puerta L 3.6mm acero inoxidable D1 ø 8mm D2 ø 10mm M4 con rosca		
Para modelos:	N140		





 <p>1</p>			
código	696640	referencia	25725554/0 CM25725554/0
descripción	casquillo para bisagra de puerta batiente int.ø 6mm L 22mm An 22mm H 14mm plástico		

 <p>1</p>			
código	696639	referencia	19060311/0 CM19060311/0
descripción	casquillo para bisagra de puerta batiente ø ext. 14mm int.ø 7.2mm L 4mm plástico		

 <p>1</p>			
código	696638	referencia	19060310/0 CM19060310/0
descripción	casquillo para bisagra de puerta batiente ø ext. 16.8mm int.ø 6.5mm L 9.5mm plástico		

 <p>1</p>			
código	695782	referencia	CMNX66028600
descripción	casquillo para puerta ø ext. 12.5mm int.ø 8.2mm L 10.8mm plástico		

 <p>1</p>			
código	694190	referencia	25110805/0 CM25110805/0
descripción	casquillo para puerta ø ext. 15.6mm int.ø 6mm L 10.8mm plástico		
Para modelos:	N140		

 <p>1</p>			
código	695700	referencia	25110919/0 CM25110919/0
descripción	casquillo para puerta ø ext. 8mm int.ø 4.4mm L 9mm plástico		

contrapuertas

 <p>1</p>			
código	695596	referencia	25250106/0 CM25250106/0
descripción	conducto hielo para puerta L 423mm An 205mm		

 <p>1</p>			
código	695702	referencia	25260475/0 CM25260475/0
descripción	parte interior de puerta para máquina de hielo L 256mm An 159mm H 65mm		
Para modelos:	N21S		

imanes

 <p>1</p>			
código	691808	referencia	41109519/0 CM41109519/0
descripción	imán de puerta con disco ø 12mm L 13mm rosca rosca Lmm		
Para modelos:	F100C, F125C, F80C, F80WC, N20L, N20WL, N25L, N25LBI, N25LW, N25S, N25SW, N35BI, N35S, N35SW, N45L, N45S, N45SW, N50BI, N50BIW, N55L, N55LW, N55S, N55SW, N70S, N70SW, N90L, N90LW, N90S, N90SW		

 <p>1</p>			
código	691809	referencia	19355005/0 CM19355005/0
descripción	imán de puerta con disco ø 9mm L 11mm		
Para modelos:	N21S		



1

código	691806	referencia	19354010/0 CM19354010/0
descripción	imán de puerta ø 22mm Lmm rosca M5 rosca L 10mm		
Para modelos:	N140		



1

código	694787	referencia	19355002/0 CM19355002/0
descripción	imán de puerta ømm L 35mm An 12mm H 15mm distancia de sujeción 26mm rosca rosca Lmm		
Para modelos:	N25BI		

bisagras



1

código	694189	referencia	25130124/0 CM25130124/0
descripción	bisagra pos. de montaje arriba árbol ø 4mm L 81mm		
Para modelos:	D310		



1

código	694221	referencia	81566732/0 CM81566732/0
descripción	bisagra pos. de montaje derecho árbol ø 6mm L 45mm An 40mm H 22mm		

puertas



1

código	696611	referencia	28180009/0 CM28180009 CM28180009/0 CMCM28180009
descripción	bandeja recogegotas para máquina de hielo An 590mm H 690mm espesor 25mm		



1

código	694325	referencia	81400692/R 81400699/0 81400699/R 81401649/0 CM81400692/R CM81400699/0 CM81400699/R CM81401649/0
descripción	puerta completo para máquina de hielo An 400mm H 347mm espesor 25mm		
Para modelos:	N20L, N20WL, N25S, N25SW		



1

código	695679	referencia	81401572/0 81401650/0 CM81401650/0
descripción	puerta completo para máquina de hielo en cubitos An 448mm H 347mm espesor 20mm		
Para modelos:	F80C, F80WC, N25L, N25LW, N35S, N35SW, N45L, N45S, N45SW, N55L, N55LW, N55S, N55SW		



1

código	695461	referencia	nicht in Preisliste enthalten
descripción	puerta Kit para máquina de hielo en cubitos An 655mm H 260mm espesor 19mm		



1 

código	695743	referencia	81460184/0 81460326/0 CM81460184/0 CM81460326/0
descripción	puerta para máquina de hielo An 1080mm H 275mm espesor 16mm		

1 

código	696654	referencia	81420505/0 81420527/0 81420528/0 CM81420528/0
descripción	puerta para máquina de hielo An 680mm H 345mm espesor 20mm		
Para modelos:	N70S, N70SW, N90L, N90LW, N90S, N90SW		

1 

código	695793	referencia	81420524/0 CM81420524/0
descripción	puerta para máquina de hielo An 680mm H 350mm espesor 20mm completo		
Para modelos:	F100C, F125C		

1 

código	695794	referencia	81440455/1 81440456/0 CM81440455/1 CM81440456/0
descripción	puerta para máquina de hielo An 880mm H 310mm espesor 20mm completo		
Para modelos:	N140		

1 

código	695669	referencia	25600186/0 CM25600186/0
descripción	puerta para máquina de hielo en cubitos An 335mm H 210mm espesor 20mm		
Para modelos:	N21S		

1 

código	695458	referencia	nicht in Preisliste enthalten
descripción	puerta para máquina de hielo en cubitos An 345mm H 195mm espesor 14mm		

1 

código	695462	referencia	nicht in Preisliste
descripción	puerta para máquina de hielo en cubitos An 395mm H 215mm espesor 18mm		

1 

código	695695	referencia	25600141/0 25600174/0 25600187/0 CM25600141/0 CM25600174/0 CM25600187/0
descripción	puerta para máquina de hielo en cubitos An 398mm H 345mm espesor 25mm apto para N25S		
Para modelos:	N20L, N20WL		



1

código	695457	referencia	nicht in Preisliste
descripción	puerta para máquina de hielo en cubitos An 505mm H 270mm espesor 21mm		



1

código	695716	referencia	81460325/0 CM81460325/0
descripción	puerta para máquina de hielo en cubitos An 805mm H 295mm		



1

código	695717	referencia	81440455/1 81440456/0 CM81440455/1 CM81440456/0
descripción	puerta para máquina de hielo en cubitos An 880mm H 310mm		



1

código	694283	referencia	81460172/0 CM81460172/0
descripción	tapa An 500mm H 295mm		

marco de puerta



1

código	695682	referencia	25165494/0 CM25165494/0
descripción	marco An 655mm H 440mm espesor 30mm		
Para modelos:	F100C, F125C, N70S, N70SW, N90L, N90LW, N90S, N90SW		



1

código	694328	referencia	81460057/0 CM81460057/0
descripción	marco de puerta An 1082mm H 442mm		
Para modelos:	D310		



1

código	695668	referencia	25165499/0 CM25165499/0
descripción	marco de puerta An 430mm H 440mm espesor 30mm		
Para modelos:	F80C, F80WC, N25L, N25LBI, N25LW, N35BI, N35S, N35SW, N45L, N45S, N45SW, N50BI, N50BIW, N55L, N55LW, N55S, N55SW		



1

código	694327	referencia	81460359/0 CM81460359/0
descripción	marco de puerta An 502mm H 770mm		
Para modelos:	D201		



1

código	694160	referencia	25165550/0 CM25165550/0
descripción	marco de puerta An 565mm H 510mm espesor 60mm		



árboles de puerta

 <p>1</p>			
código	695701	referencia	25085096/0 CM25085096/0
descripción	para árbol de puerta		
Para modelos:	N20L, N20WL, N25BI, N25S, N25SW		

 <p>1</p>			
código	695667	referencia	25560141/0 CM25560141/0
descripción	para árbol de puerta para máquina de hielo ø 4mm L 1025mm acero inoxidable		
Para modelos:	D310		

 <p>1</p>			
código	695706	referencia	25560142/0 CM25560142/0
descripción	para árbol de puerta para máquina de hielo ø 4mm L 485mm acero inoxidable		

 <p>1</p>			
código	695710	referencia	25560135/0 CM25560135/0
descripción	para árbol de puerta para máquina de hielo ø 4mm L 755mm acero inoxidable		

 <p>1</p>			
código	695703	referencia	25030019/0 CM25030019/0
descripción	para árbol de puerta para máquina de hielo ø 6mm L 360mm acero inoxidable		
Para modelos:	F80C, F80WC, N25L, N25LBI, N25LW, N35BI, N35S, N35SW, N45L, N45S, N45SW, N50BI, N50BIW, N55L, N55LW, N55S, N55SW		

 <p>1</p>			
código	695704	referencia	25030020/0 CM25030020/0
descripción	para árbol de puerta para máquina de hielo ø 6mm L 585mm acero inoxidable		
Para modelos:	F125C, N70S, N70SW, N90L, N90LW, N90S, N90SW		

 <p>1</p>			
código	695711	referencia	25560285/0 CM25560285/0
descripción	para árbol de puerta para máquina de hielo ø 6mm L 890mm rosca M4 acero inoxidable		
Para modelos:	N140		

cortinas

sin soporte

 <p>1</p>			
código	695726	referencia	81401600/0 CM81401600/0
descripción	cortina para máquina de hielo An 250mm H 70mm longitud árbol 270mm árbol ø 6mm		
Para modelos:	N21S		

 <p>1</p>			
código	695429	referencia	nicht in Preisliste enthalten
descripción	cortina para máquina de hielo An 250mm H 70mm longitud árbol 280mm árbol ø 6mm		

 <p>1</p>			
código	695440	referencia	nicht in Preisliste
descripción	cortina para máquina de hielo An 283mm H 115mm longitud árbol 305mm árbol ø 6mm		

			
1			
código	695076	referencia	nicht in Preisliste enthalten
descripción	cortina para máquina de hielo An 284mm H 83mm		

			
1			
código	695075	referencia	nicht in Preisliste
descripción	cortina para máquina de hielo An 305mm H 115mm longitud árbol 323mm árbol ø 6mm		

			
1			
código	695439	referencia	nicht in preisliste enthalten
descripción	cortina para máquina de hielo An 407mm H 84mm longitud árbol 458mm árbol ø 6mm		

			
1			
código	695441	referencia	nicht in Preisliste
descripción	cortina para máquina de hielo An 574mm H 115mm longitud árbol 610mm árbol ø 6mm		

accesorios

soportes

			
1			
código	695079	referencia	19797109/0 19797112/0 CM19797109/0 CM19797112/0 CMXP66038801
descripción	portacortinas para máquina de hielo An 15mm H 80mm derecho		
Para modelos:	N21S		

			
1			
código	695080	referencia	19797108/0 19797111/0 CM19797108/0 CM19797111/0
descripción	portacortinas para máquina de hielo An 15mm H 80mm izquierdo		
Para modelos:	N21S		

parte mecánica para cubetas

cubetas

			
1			
código	695662	referencia	25820125/0 CM25820125/0
descripción	contenedor de agua para máquina de hielo L 697mm An 260mm H 148mm blanco		
Para modelos:	N201M, N301M, N401M, N501M		

			
1			
código	695018	referencia	81423002/0 CM81423002/0
descripción	cubeta completo L 455mm An 180mm H 60mm ICEMATIC		
Para modelos:	N70S, N70SW, N90S, N90SW		

			
1			
código	694818	referencia	81400278/0 CM81400278/0
descripción	cubeta completo para máquina de hielo en cubitos L 275mm An 223mm H 80mm blanco		

			
1			
código	695014	referencia	25098060/0 81403005/0 CM25098060/0 CM81403005/0
descripción	cubeta completo para máquina de hielo L 180mm An 125mm H 80mm eje L 205mm N20 azul		
Para modelos:	N20L, N20WL, N25S, N25SW		



1

código	696414	referencia	81401621/0 CM81401621/0
descripción	cubeta completo para máquina de hielo L 180mm An 125mm H 80mm eje L 210mm N25 azul		
Para modelos:	N25BI, N25L, N25LBI, N25LW, N25S, N25SW		



1

código	696751	referencia	CM81400064/0
descripción	cubeta completo para máquina de hielo L 182mm An 160mm ICEMATIC blanco		



1

código	696649	referencia	81400004/0 CM81400004/0
descripción	cubeta completo para máquina de hielo L 220mm An 130mm H 80mm blanco/azul		



1

código	696650	referencia	25098057/0 CM25098057/0
descripción	cubeta completo para máquina de hielo L 220mm An 167mm H 80mm blanco		



1

código	695015	referencia	81403007/0 CM81403007/0
descripción	cubeta completo para máquina de hielo L 225mm An 165mm H 80mm eje L 255mm blanco		
Para modelos:	N35BI, N35S, N35SW		



1

código	699148	referencia	81414467/0 CM81414467/0
descripción	cubeta completo para máquina de hielo L 275mm An 200mm H 60mm gris		
Para modelos:	N45L		



1

código	695016	referencia	81414519/0 81423003/0 CM81414519/0 CM81423003/0
descripción	cubeta completo para máquina de hielo L 275mm An 220mm blanco		
Para modelos:	N55L, N55LW		



1

código	695017	referencia	81413001/0 CM81413001/0
descripción	cubeta completo para máquina de hielo L 275mm An 220mm H 75mm ICEMATIC blanco		
Para modelos:	N45S, N45SW, N50BI, N50BIW, N55S, N55SW		



1

código	699146	referencia	81400154/0 CM81400154/0
descripción	cubeta completo para máquina de hielo L 450mm An 200mm H 60mm gris		



1

código	699149	referencia	81453705/0 CM81453705/0
descripción	cubeta completo para máquina de hielo L 490mm An 150mm H 260mm blanco		
Para modelos:	N131M		

			
1			
código	699147	referencia	81426054/0 CM81426054/0
descripción	cubeta completo para máquina de hielo L 630mm An 355mm H 100mm gris		
Para modelos:	N90L, N90LW		

			
1			
código	696647	referencia	25820130/0 CM25820130/0
descripción	cubeta para máquina de hielo L 680mm An 240mm H 150mm blanco		

			
1			
código	695019	referencia	81442008/0 CM81442008/0
descripción	cubeta completo para máquina de hielo L 690mm An 230mm H 65mm ICEMATIC		

			
1			
código	695657	referencia	81442008/0 CM81442008/0
descripción	cubeta para máquina de hielo L 690mm An 230mm H 75mm		
Para modelos:	N140		

			
1			
código	696618	referencia	81300066 81300066/0 81300067 81300067/0 CM81300066/0 CM81300067/0
descripción	cubeta para máquina de hielo L 360mm An 175mm H 70mm blanco		

			
1			
código	696682	referencia	81453588/0 CM81453588/0
descripción	cubeta para máquina de hielo L 697mm An 230mm H 150mm blanco		

			
1			
código	696619	referencia	81300090/0 81300091/0 CM81300090/0 CM81300091/0
descripción	cubeta para máquina de hielo L 450mm An 185mm H 70mm blanco		

recambios y accesorios

			
1			
código	695376	referencia	25110924/0 CM25110924/0
descripción	anillo de ajuste para árbol H 7mm int.ø 6mm ø ext. 12mm rosca M4 acero inoxidable		

			
1			
código	695882	referencia	19644000/0 CM19644000/0
descripción	anillo distnciador para árbol ø ext. 12mm int.ø 6.2mm L 2mm goma		

			
1			
código	696648	referencia	25820132/0 CM25820132/0
descripción	cubeta para máquina de hielo L 490mm An 235mm H 160mm blanco		

			
1			
código	695479	referencia	81413043/0 CM81413043/0
descripción	arandela para basculación cuba ø 100mm árbol ø 7mm		
Para modelos:	N140, N45S, N45SW, N50BI, N50BIW, N55L, N55LW, N55S, N55SW, N70S, N70SW, N90L, N90LW, N90S, N90SW		





			
1			
código	695671	referencia	25260001/1 CM25260001/1
descripción	arandela para basculación cuba ø 100mm árbol ø 7mm		

			
1			
código	695670	referencia	25260000/0 CM25260000/0
descripción	arandela para basculación cuba ø 100mm soporte de eje ø 7mm		
Para modelos:	N20L, N20WL, N25BI, N25L, N25LBI, N25LW, N25S, N25SW, N35BI, N35S, N35SW, N45L		

			
1			
código	695004	referencia	25030006/0 CM25030006/0
descripción	árbol para máquina de hielo ø 6mm L 165mm inox		
Para modelos:	N20L, N20WL, N25BI, N25S, N25SW		

			
1			
código	695005	referencia	25030007/0 CM25030007/0
descripción	árbol para máquina de hielo ø 6mm L 206mm		
Para modelos:	N35BI, N35S, N35SW		

			
1			
código	695006	referencia	25030010/0 CM25030010/0
descripción	árbol para máquina de hielo ø 6mm L 315mm inox		
Para modelos:	N45S, N45SW, N50BI, N50BIW, N55L, N55LW, N55S, N55SW		

			
1			
código	695007	referencia	25030011/0 CM25030011/0
descripción	árbol para paleta L 495mm		
Para modelos:	N70S, N70SW, N90L, N90LW, N90S, N90SW		

			
1			
código	695008	referencia	25085011/0 CM25085011/0
descripción	árbol para paleta L 740mm		
Para modelos:	N140		

			
1			
código	695681	referencia	19800179/0 25110914/0 CM19800179/0 CM25110914/0
descripción	casquillo para árbol ø ext. 10mm int.ø 6.2mm L 20mm plástico ICEMATIC		
Para modelos:	N20L, N20WL, N25L, N25LW, N25S, N25SW, N35S, N35SW, N45L, N45S, N45SW, N50BI, N50BIW, N55L, N55LW, N55S, N55SW, N70S, N70SW, N90L, N90LW, N90S, N90SW		

			
1			
código	697880	referencia	25030004/0 CM25030004/0
descripción	eje para cubeta para máquina de hielo en cubitos L 205mm ø 10mm		
Para modelos:	N20L, N20WL, N25BI, N25S, N25SW		

			
1			
código	695023	referencia	25325953 25325953/1 CM25325953/1
descripción	guía para palanca L 30mm An 12mm H 15mm		
Para modelos:	N140, N20L, N20WL, N25L, N25LW, N25S, N25SW, N35S, N35SW, N45S, N45SW, N50BI, N50BIW, N55L, N55LW, N55S, N55SW, N70S, N70SW, N90L, N90LW, N90S, N90SW		

			
1			
código	695674	referencia	25475400/0 CM25475400/0
descripción	muelle de tracción para cubeta ø 13mm espesor de hilo 1.7mm L1 80mm		
Para modelos:	N140		

			
1			
código	695025	referencia	25440110/0 81403011/0 CM25440110/0 CM81403011/0
descripción	palanca para cubeta L 143mm An 29mm H 37mm soporte de eje ø 10mm plástico ICEMATIC		
Para modelos:	N20L, N20WL, N25BI, N25L, N25LBI, N25LW, N25S, N25SW, N35BI, N35S, N35SW, N45L, N45S, N45SW, N50BI, N50BIW, N55L, N55LW, N55S, N55SW, N70S, N70SW, N90L, N90LW, N90S, N90SW		

			
1			
código	695645	referencia	81442071/0 CM81442071/0
descripción	palanca para cubeta L 143mm An 38mm H 29mm inox		
Para modelos:	N140		

			
1			
código	695653	referencia	81443045/2 CM81443045/2
descripción	palanca para cubeta L 90mm An 20mm soporte de eje ø 10mm		
Para modelos:	N140		

			
1			
código	695026	referencia	25560254/1 25560256/0 CM25560254/1 CM25560256/0
descripción	pasador para palanca L 38mm ø 4.5mm metal		
Para modelos:	N140, N20L, N20WL, N25BI, N25L, N25LBI, N25LW, N25S, N25SW, N35BI, N35S, N35SW, N45L, N45S, N45SW, N50BI, N50BIW, N55L, N55LW, N55S, N55SW, N70S, N70SW, N90L, N90LW, N90S, N90SW		

			
1			
código	695027	referencia	24555520 24555522 25545520/2 25545522 CM25545520/2
descripción	remo ø 145mm soporte de eje ø 6mm		
Para modelos:	N140, N20L, N20WL, N25BI, N25L, N25LBI, N25LW, N25S, N25SW, N35BI, N35S, N35SW, N45L, N45S, N45SW, N50BI, N50BIW, N55L, N55LW, N55S, N55SW, N70S, N70SW, N90L, N90LW, N90S, N90SW		

			
1			
código	696527	referencia	25545521/0 CM25545521/0
descripción	remo ø 145mm soporte de eje ø 6mm longitud árbolmm 1		

			
1			
código	696612	referencia	25545509/0 CM25545509/0
descripción	remo para máquina de hielo ø 150mm soporte de eje ø 6mm 1		

			
1			
código	695021	referencia	25474600/0 CM25474600/0
descripción	resorte de torsión ø 20.8mm L1 23.2mm L2 37mm espesor de hilo 2.3mm para máquina de hielo		
Para modelos:	N20L, N20WL, N25BI, N25L, N25LBI, N25LW, N25S, N25SW, N35BI, N35S, N35SW		

			
1			
código	695022	referencia	25474602/0 CM25474602/0
descripción	resorte de torsión ø 21.2mm L1 26mm L2 37mm espesor de hilo 2.6mm para máquina de hielo		
Para modelos:	N45L, N45S, N45SW, N50BI, N50BIW, N55L, N55LW, N55S, N55SW, N70S, N70SW, N90L, N90LW, N90S, N90SW		

			
1			
código	695676	referencia	25474601/0 CM25474601/0
descripción	resorte de torsión ø 23.5mm L1 29mm L2 38mm espesor de hilo 3mm para máquina de hielo		
Para modelos:	N140		

			
1			
código	695024	referencia	25110910 25110910/0 25110911/0 CM25110910/0 CM25110911/0
descripción	rollo para basculación cuba ø 26.7mm soporte de eje ø 8.1mm		
Para modelos:	N140, N20L, N20WL, N25S, N25SW, N45S, N45SW, N50BI, N50BIW, N55L, N55LW, N55S, N55SW, N70S, N70SW		

			
1			
código	695009	referencia	25726115 25726115/3 CM25726115/3
descripción	soporte paleta L 50mm An 17mm H 23mm soporte de eje ø 6.5mm distancia de sujeción 30mm		
Para modelos:	N140, N20L, N20WL, N25BI, N25L, N25LBI, N25LW, N25S, N25SW, N35BI, N35S, N35SW, N45L, N45S, N45SW, N50BI, N50BIW, N55L, N55LW, N55S, N55SW, N70S, N70SW, N90L, N90LW, N90S, N90SW		

			
1			
código	695646	referencia	25726279/0 25726478/0 CM25726279/0 CM25726478/0
descripción	soporte para contrapuerta L 44mm An 20mm H 18mm soporte de eje ø 6.3mm distancia de sujeción 30mm		
Para modelos:	F125C, F80C, F80WC, N20L, N20WL, N25BI, N25L, N25LBI, N25LW, N25S, N25SW, N35BI, N35S, N35SW, N45L, N45S, N45SW, N50BI, N50BIW, N55L, N55LW, N55S, N55SW, N70S, N70SW, N90L, N90LW, N90S, N90SW		



1

código	695415	referencia	25726122/0 25726124/0 CM25726122/0 CM25726124/0
descripción	soporte para cubeta pos. de montaje derecho ICEMATIC		
Para modelos:	N140, N20L, N20WL, N25BI, N25L, N25LBI, N25LW, N25S, N25SW, N35BI, N35S, N35SW, N45L, N45S, N45SW, N50BI, N50BIW, N55L, N55LW, N55S, N55SW, N70S, N70SW, N90L, N90LW, N90S, N90SW		



1

código	695414	referencia	25726121/0 CM25726121/0 CM25726123/0
descripción	soporte para cubeta pos. de montaje izquierdo L 237mm An 15mm H 50mm ICEMATIC		
Para modelos:	N140, N20L, N20WL, N25BI, N25L, N25LBI, N25LW, N25S, N25SW, N35BI, N35S, N35SW, N45L, N45S, N45SW, N50BI, N50BIW, N55L, N55LW, N55S, N55SW, N70S, N70SW, N90L, N90LW, N90S, N90SW		



1

código	695651	referencia	25525419/0 CM25525419/0
descripción	soporte para impulsador L 34mm An 15mm H 60mm		
Para modelos:	N140, N20L, N20WL, N25BI, N25L, N25LBI, N25LW, N25S, N25SW, N35BI, N35S, N35SW, N45L, N45S, N45SW, N50BI, N50BIW, N55L, N55LW, N55S, N55SW, N70S, N70SW, N90L, N90LW, N90S, N90SW		



1

código	695720	referencia	25725429/0 CM25725429/0
descripción	soporte para motor de fluido L 92mm An 92mm metal		
Para modelos:	N20L, N20WL, N25L, N25LBI, N25LW, N35BI, N35S, N35SW, N45L, N45S, N45SW, N50BI, N50BIW, N55L, N55LW, N55S, N55SW, N70S, N70SW, N90L, N90LW, N90S, N90SW		



1

código	695035	referencia	25725433/0 25725439/0 CM25725433/0 CM25725439/0
descripción	soporte de eje para motor a palas L 30mm An 17mm H 60mm soporte de eje ø 4mm distancia de sujeción 17mm		
Para modelos:	N140, N20L, N20WL, N25BI, N25L, N25LBI, N25LW, N25S, N25SW, N35BI, N35S, N35SW, N45L, N45S, N45SW, N50BI, N50BIW, N55L, N55LW, N55S, N55SW, N70S, N70SW, N90L, N90LW, N90S, N90SW		

ruedas dentadas



1

código	698584	referencia	CF65115700 CMCF65115700
descripción	rueda dentada ø 101mm soporte de eje ø 12.72mm transmisión 16/94 doble para máquina de hielo		
Para modelos:	SF300, SF500, SFN1000, SFN1000W		



1

código	691787	referencia	29028004
descripción	rueda dentada ø 27/101mm soporte de eje ø 13mm dientes 15/94		

sistema de aspiración

cubetas de desagüe



1

código	695666	referencia	25820080/0 CM25820080/0 CM25820115/0	
descripción	cubeta para máquina de hielo L 220mm An 34mm H 290mm			
Para modelos:	N25L, N25LBI, N25LW, N35BI, N35S, N35SW, N45L, N45S, N45SW, N50BI, N50BIW, N55L, N55LW, N55S, N55SW, N70S, N70SW, N90L, N90LW, N90S, N90SW			
accesorios para	695666			
	código	695713	referencia	81443002/0 CM81443002/0
	rejilla de protección para cubeta desagüe			

cubetas de aspiración

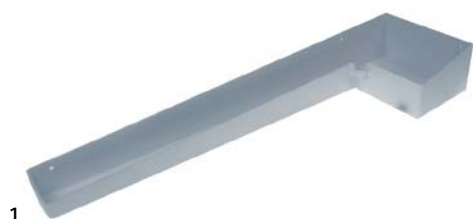

código	695732	referencia	81453116/0 CM81453116/0
descripción	contenedor de agua para máquina de hielo L 698mm An 195mm H 93mm		
Para modelos:	N200M, N200MW, N300M, N300MW		

técnica de propulsión

ruedas dentadas



código	695582	referencia	290286006 CF65115600 CMCF65115600
descripción	rueda dentada dientes 65 ancho de diente 14.5mm ø ext. 74mm H 72mm árbol ø 12.7mm		
Para modelos:	SF300, SF500, SFN1000, SFN1000W		



código	694780	referencia	29028005 65115800 CF65115800 CMCF65115800
descripción	rueda dentada ø 135mm eje ø 25mm An 19mm dientes 83		
Para modelos:	SF300, SF500, SFN1000, SFN1000W		



código	695586	referencia	CF65116000 CMCF65116000
descripción	rueda dentada ø 21.3mm dientes 18-41 D1 ø 58mm eje ø 8 eje L 55mm		
Para modelos:	F100, F100C, F120, F125C, F200, F80C, F80WC		



código	697919	referencia	CF65116100 CMCF65116100
descripción	rueda dentada ø 62/20mm eje ø 9.5mm dientes 56/10 para mecanismo		
Para modelos:	F100, F100C, F120, F125C, F200, F80C, F80WC		

juntas

juntas de árbol



código	696651	referencia	CF02001607 CF02160701 CMCF02001607 CMCF02160701
descripción	cojinete de árbol para máquina de hielo ø ext. 33.5mm int.ø 25.7mm H 3mm para cojinete de árbol metal		
Para modelos:	SF300, SF500, SFN1000, SFN1000W		



código	694191	referencia	CF13070902 CMCF13070902
descripción	junta para evaporador ø ext. 48mm int.ø 23mm H 7mm goma		
Para modelos:	SF300, SF500, SFN1000, SFN1000W		



código	695589	referencia	29000003/0 CF64004000 CM29000003/0 CMCF64004000
descripción	junta de árbol ø ext. 48mm int.ø 25mm H 22mm apto para tornillo sinfin		
Para modelos:	F100, F100C, F120, F125C, F200, F80C, F80WC		



código	695428	referencia	CF65040200 CMCF65040200
descripción	junta de árbol para esparrago ø ext. 45mm int.ø 30mm		
Para modelos:	SF300, SF500, SFN1000, SFN1000W		

otros

código	900912	referencia	38581100/0 CM38581100/0
descripción	junta para frigorífico An 18mm para puerta UE al metro		
Para modelos:	N140		

código	697879	referencia	1300061738 CM1300061738
descripción	junta tórica NBR espesor 2.62mm int.∅ 219mm UE 1 pzs		
Para modelos:	SF300, SF500		

cajas y paneles frontales

paneles

código	692219	referencia	81453613/0 CM81453613/0
descripción	revestimiento An 180mm H 46mm P 48mm		

código	696581	referencia	81453604/0 CM81453604/0
descripción	revestimiento para LED H 75mm para ICEMATIC N501M L 240mm		
Para modelos:	N131M, N201M, N301M, N401M, N501M		

carcasas

código	696646	referencia	25161164/0 CM25161143 CM25161164/0
descripción	caja para distribución L 245mm An 245mm H 140mm		

código	696635	referencia	25160731/0 CM25160731/0
descripción	caja para distribución L 255mm An 225mm H 98mm		

código	696653	referencia	25165522/0 CM25165522/0
descripción	marco para máquina de hielo L 610mm An 405mm H 100mm		

código	696685	referencia	25702906/0 CM25702906/0
descripción	marco para máquina de hielo L 765mm An 495mm H 110mm plástico antracita		

código	696656	referencia	25161138/0 CM25161138/0
descripción	tapa para distribución L 99mm An 38.4mm H 9mm plástico modelo N25 plata		
Para modelos:	F80C, F80WC, N21S, N25L, N25LW, N25S, N25SW, N35S, N35SW, N45L, N45S, N45SW, N55L, N55LW, N55S, N55SW, N70S, N70SW, N90L, N90LW, N90S, N90SW		

regillas de ventilación



1

código	694142	referencia	25547146/0 CM25547146/0
descripción	rejilla de ventilación L 335mm An 20mm H 335mm		



1

código	696655	referencia	25295030/0 CM25295030/0
descripción	rejilla de ventilación plástico negro H 233mm L 233mm		

tarjeta de identificación



1

código	694824	referencia	19263215/0 CM19263215/0
descripción	rótulo de marca ICEMATIC autoadhesivo azul/blanco L 120mm An 120mm		



1

código	696636	referencia	19262800/0 CM19262800/0
descripción	tarjeta identificación Scotsman MV 1000 L 265mm An 76mm autoadhesivo		

aislamientos



1

código	694112	referencia	CF06055101 CF6055101 CMCF06055101 CMCF6055101
descripción	aislamiento para canal de expulsión L 190mm An 200mm H 175mm		



1

código	695989	referencia	CF06055104 CMCF06055104
descripción	aislamiento para máquina de hielo H 230mm ø 117mm		

tapa



1

código	696610	referencia	81453072 81453131/0 CM81453131/0
descripción	cubeta para máquina de hielo An 500mm H 70mm L 540mm para evaporador		



1



código	695728	referencia	25260474/0 25260485/0 CM25260474/0 CM25260485/0
descripción	tapa para máquina de hielo An 265mm H 130mm		
Para modelos:	N21S		

1



código	696645	referencia	25550400/0 CM25550400/0
descripción	tapa para máquina de hielo An 473mm L 420mm para evaporador		

1



código	696644	referencia	81453466/0 CM81453466/0	
descripción	tapa para máquina de hielo An 365mm L 410mm para evaporador			
repuestos para	696644			
	código	347059	referencia	19355007/0 CM19355007/0
imán L 40mm H 8mm An 13.2mm dist. del agujero 30mm				

1



código	695693	referencia	81453630/0 CM81453630/0	
descripción	tapa para máquina de hielo An 493mm L 423mm para evaporador			
Para modelos:	N201M, N301M			
repuestos para	695693			
	código	347059	referencia	19355007/0 CM19355007/0
imán L 40mm H 8mm An 13.2mm dist. del agujero 30mm				

1



código	696641	referencia	81453692/0 CM81453692/0	
descripción	tapa para máquina de hielo An 365mm L 420mm para evaporador			
Para modelos:	N131M			
repuestos para	696641			
	código	347059	referencia	19355007/0 CM19355007/0
imán L 40mm H 8mm An 13.2mm dist. del agujero 30mm				

1



código	696392	referencia	25820114/0 81453008/0 81453130/0 CM25820114/0 CM81453008/0 CM81453130/0
descripción	tapa para máquina de hielo An 493mm L 423mm para evaporador		



1

código	696642	referencia	25820126/0 CM25820126/0
descripción	tapa para máquina de hielo An 493mm L 423mm para evaporador		
Para modelos:	N201M, N301M		
accesorios para	696642		
	código	347059	referencia
			19355007/0 CM19355007/0
	imán L 40mm H 8mm An 13.2mm dist. del agujero 30mm		



1

código	696643	referencia	81453651/0 CM81453651/0
descripción	tapa para máquina de hielo An 525mm L 640mm para evaporador		
Para modelos:	N501M		
repuestos para	696643		
	código	347059	referencia
			19355007/0 CM19355007/0
	imán L 40mm H 8mm An 13.2mm dist. del agujero 30mm		



1

código	695697	referencia	81453261/0 CM81453261/0
descripción	tapa para máquina de hielo An 495mm H 560mm espesor 38mm		
Para modelos:	N500M		



1

código	695698	referencia	81453262/0 CM81453262/0
descripción	tapa para máquina de hielo An 495mm H 560mm espesor 38mm		
Para modelos:	N500M		

partes mecánicas para evaporadores

tornillos sin fin



1

código	691788	referencia	CF72405207 CMCF72405207
descripción	tornillo sin fin ø 46mm L 260mm		
Para modelos:	F100, F100C, F120, F125C, F80C, F80WC		





1

código	691789	referencia	CF72405206 CMCF72405206
descripción	tornillo sin fin ø 46mm L 330mm		
Para modelos:	F200		

soportes			
 <p>1</p>			
código	694437	referencia	06068800 29015012 29070002 65105900 CF06052700 CF06068800 CF65105900 CF75400801 CMCF06052700 CMCF06068800 CMCF65105900 CMCF75400801
descripción	soporte de rodamiento para evaporador Kit con soporte pos. de montaje abajo		
Para modelos:	SF300, SF500		

otros			
 <p>1</p>			
código	560568	referencia	CF02167900 CF02168100 CMCF02001681 CMCF02167900 CMCF02168100
descripción	arandela int.ø 25.6mm ø ext. 39mm espesor 0.85mm inox UE 1 pzs		
Para modelos:	SF300, SF500, SFN1000, SFN1000W		

 <p>1</p>			
código	694598	referencia	CF78447601 CMCF78447601
descripción	soporte de imán con imán H 37mm ø ext. 42mm plástico		
Para modelos:	SFN1000, SFN1000W		

motorreductores			
mecanismo			
 <p>1</p>			
código	694352	referencia	CF00101501 CMCF00101501
descripción	caja para mecanismo		
Para modelos:	F100, F100C, F120, F125C, F200, F80C, F80WC		

 <p>1</p>			
código	695607	referencia	29070007 CFA3123001 CMCF3123001
descripción	caja para mecanismo		
Para modelos:	SF300, SF500, SFN1000, SFN1000W		

tubos flexibles			
tubos formados			
forma S			
 <p>1</p>			
código	694093	referencia	nicht in Preisliste enthalten
descripción	tubo formado forma S para máquina de hielo en cubitos int.ø 18mm ø ext. 22mm L 300mm An 100mm		

 <p>1</p>			
código	695885	referencia	25778366/0 CM25778366/0
descripción	tubo formado forma S para máquina de hielo en cubitos int.ø 20mm ø ext. 25mm L 800mm An 130mm H 80mm		
Para modelos:	N140		

otros			
 <p>1</p>			
código	695813	referencia	29090034/0 CM29090034/0
descripción	tubo formado int.ø 11mm ø ext. 15mm L 500mm An 110mm		



código	694104	referencia	nicht in Preisliste enthalten
descripción	tubo formado int.ø 16mm ø ext. 20mm L 440mm An 210mm PVC		

empalmes de tubo

con rosca



código	695045	referencia	CF66022400 CM25631035 CMCF66022400
descripción	empalme de tubo 3 vías int.ø 15mm ø ext. 21mm L 91mm		
Para modelos:	F100, F120, F125C, F200, F80C, F80WC, SF300, SF500		



código	695048	referencia	nicht in Preisliste enthalten
descripción	empalme de tubo para máquina de hielo en cubitos		



código	361796	referencia	nicht in Preisliste
descripción	empalme de tubo rosca 3/4" M boquilla ø 13.5mm int.ø 10mm longitud boquilla 20mm EC 27 rosca L 22mm		

sin rosca



código	696615	referencia	25631050/0 CM25631050/0
descripción	empalme de desagüe tubo ø 25mm L 100mm plástico para máquina de hielo		



código	695737	referencia	25631035/0 CM25631035/0
descripción	empalme de tubo recto plástico L 60mm ø 20mm		
Para modelos:	N21S		



código	695050	referencia	25690803 25690806/0 CM25690806/0
descripción	empalme de tubo recto plástico L 70mm ø 21mm		
Para modelos:	F100C, F125C, F80C, F80WC, N200M, N200MW, N20L, N20WL, N25BI, N25L, N25LW, N25S, N25SW, N300M, N300MW, N35S, N35SW, N45L, N45S, N45SW, N500M, N55L, N55LW, N55S, N55SW, N70S, N70SW, N90L, N90LW, N90S, N90SW		

distribuidores de agua



código	696617	referencia	81453698/0 CM81453698/0
descripción	juego de tubos para máquina de hielo int.ø 12mm ø ext. 16mm L 600mm An 20mm goma H 116mm		





código	694823	referencia	25790075/0 81454208/0 CM25790075/0 CM81454208/0
descripción	tubo flexible pieza T L 580mm para máquina de hielo		



código	694791	referencia	81453791/0 CM81453791/0
descripción	tubo flexible pieza T L 80mm		
Para modelos:	N501M		



otros			
 <p>1</p>			
código	520447	referencia	73320400 CF73320400 CMCF73320400
descripción	boquilla doble rosca 3/8" - 3/4" L1 24mm L2 12mm		
Para modelos:	F100, F120, F200, SF300, SF500, SFN1000W		

 <p>1</p>			
código	530769	referencia	25790880/0 CM25790880/0
descripción	tubo de silicona para máquina de hielo en cubitos int.ø 14mm ø ext. 20mm L 650mm		

 <p>1</p>			
código	530768	referencia	25791018/0 CM25791018/0
descripción	tubo flexible para máquina de hielo en cubitos int.ø 10mm ø ext. 16mm L 800mm		
Para modelos:	N20L, N20WL, N25BI, N25S, N25SW		

flotadores			
tapas de recipientes			
 <p>1</p>			
código	695038	referencia	CF66036300 CMCF66036300
descripción	tapa L 150mm An 102mm para recipiente de flotador		
Para modelos:	F100, F120, F125C, F200, F80C, F80WC, SF300, SF500, SFN1000, SFN1000W		

contenedores flotantes			
 <p>1</p>			
código	695037	referencia	29087022/0 79312601 CF79312601 CM29087022/0 CMCF79312601
descripción	recipiente de flotador para máquina de hielo plástico		
Para modelos:	F100, F120, F125C, F200, F80C, F80WC, SFN1000, SFN1000W		

otros			
 <p>1</p>			
código	695744	referencia	CF66013200 CMCF65088700 CMCF66013200
descripción	aislamiento L 150mm An 100mm H 140mm int.ø 55mm		
Para modelos:	F100, F120, F200		

 <p>1</p>			
código	695723	referencia	25410055/0 CM25410055/0
descripción	aislamiento para válvula regulación L 120mm An 52mm H 105mm		

 <p>1</p>			
código	696683	referencia	25410096/0 CM25410096/0
descripción	aislamiento para válvula regulación L 85mm An 50mm H 70mm		

 <p>1</p>			
código	695585	referencia	CF72418000 CF72418002 CMCF72418000 CMCF72418002
descripción	barra roscada rosca M4 L1 130mm L2 22mm		
Para modelos:	F100, F120, F200, SF300, SF500, SFN1000, SFN1000W		

			
1			
código	696623	referencia	19120414/0 CM19120414/0
descripción	bisagra para máquina de hielo L 78mm An 38mm H 57mm pos. de montaje derecho		

			
1			
código	696624	referencia	19120415/0 CM19120415/0
descripción	bisagra para máquina de hielo L 78mm An 38mm H 57mm pos. de montaje izquierdo		

			
1			
código	695709	referencia	81462028/0 CM81462028/0
descripción	canal de expulsión para máquina de hielo L 135mm An 80mm H 80mm		
Para modelos:	F100C		

			
1			
código	696684	referencia	25702875/0 CM25702875/0
descripción	casquillo int.ø 4.4mm D1 ø 28mm D2 ø 12.75mm L1 25mm		

			
1			
código	696621	referencia	25560151/0 25560152/0 CM25560151/0 CM25560152/0
descripción	casquillo L 9mm An 14mm H 19mm int.ø 4.5mm plástico		
Para modelos:	N55L, N55LW, N55S, N55SW, N70S, N70SW, N90L, N90LW, N90S, N90SW		

			
1			
código	696620	referencia	25110913/0 CM25110913/0
descripción	casquillo para máquina de hielo L 13mm An 8mm H 9mm int.ø 4mm ø ext. 8mm plástico		
Para modelos:	N21S, N45S, N45SW, N50BI, N50BIW		

			
1			
código	696652	referencia	25260525/0 CM25260525/0
descripción	casquillo separador para máquina de hielo H 1.5mm int.ø 4mm ø ext. 10mm inox UE 1 pzs		
Para modelos:	N140, N20L, N20WL		

			
1			
código	692840	referencia	81414560/0
descripción	chapa de montaje L 62mm An 60mm H 10mm para 360665		

			
1			
código	695672	referencia	25726140/0 CM25726140/0
descripción	clip para bulbo L 12mm An 27mm H 18mm agujero ø 9.5mm		
Para modelos:	N140, N25L, N25LBI, N25LW, N35BI, N35S, N35SW, N45S, N45SW, N50BI, N50BIW, N55L, N55LW, N55S, N55SW, N70S, N70SW, N90L, N90LW, N90S, N90SW		

			
1			
código	695661	referencia	25726141/0 CM25726141/0
descripción	clip para bulbo L 40mm An 25mm H 18mm agujero ø 9.5mm		
Para modelos:	N140, N25L, N25LBI, N25LW, N35BI, N35S, N35SW, N45S, N45SW, N50BI, N50BIW, N55L, N55LW, N55S, N55SW, N70S, N70SW, N90L, N90LW, N90S, N90SW		

			
1			
código	695588	referencia	CF06052700 CF65015900 CMCF06052700 CMCF65015900
descripción	cojinete completo H 31.5mm int.ø 30mm ø ext. 89mm pos. de montaje abajo		
Para modelos:	SF300, SF500, SFN1000, SFN1000W		





 <p>1</p>			
código	694438	referencia	nicht in Preisliste
descripción	cubeta L 205mm An 100mm H 19mm		

 <p>1</p>			
código	696622	referencia	19270501/0 CM19270501/0
descripción	émbolo para máquina de hielo L 63mm An 48mm H 88mm 230VAC para modelo N202M/N302M/M192/M202/M302		

 <p>1</p>			
código	698719	referencia	19270502/0 CM19270502/0
descripción	émbolo para máquina de hielo L 63mm An 48mm H 88mm 230VAC para modelo N402M/N502M/M402/M502		

 <p>1</p>			
código	695584	referencia	nicht in Preisliste
descripción	grapa elástica L 28mm An 10mm agujero ø 4.5mm tubo ø 31mm		

 <p>1</p>			
código	695630	referencia	CF06035900 CMCF06035900
descripción	juego de acoplamiento ø 37mm		
Para modelos:	F100, F100C, F120, F125C, F200, F80C, F80WC		

 <p>1</p>			
código	695673	referencia	25730501/0 CM25730501/0
descripción	junta para dispensador de agua H 19mm int.ø 16mm ø ext. 27mm pos. de montaje izquierdo		

 <p>1</p>			
código	695719	referencia	I-1611
descripción	junta para máquina de hielo L 80mm An 36mm silicona		

 <p>1</p>			
código	695753	referencia	29090049/0 CM29090049/0
descripción	manguito de goma L 25mm An 18mm H 18mm int.ø 7mm ø ext. 18mm		

 <p>1</p>			
código	695731	referencia	81453015/0 CM81453015/0
descripción	regulador de cantidad L 42mm An 14mm		
Para modelos:	N131M, N200M, N200MW, N201M, N300M, N300MW, N301M, N401M, N501M		

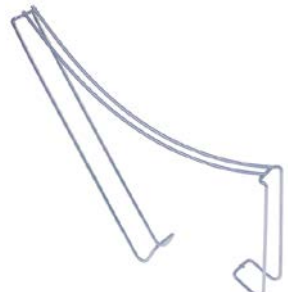
 <p>1</p>			
código	695713	referencia	81443002/0 CM81443002/0
descripción	rejilla de protección para cubeta desagüe		
Para modelos:	N140		

 <p>1</p>			
código	695764	referencia	29070018/0 CF72421506 CM29070018/0 CMCF72421506
descripción	sensor L 100mm ø ext. 4mm rosca M3		
Para modelos:	F100, F100C, F120, F125C, F200, F80C, F80WC, SF300, SF500, SFN1000, SFN1000W		

 <p>1</p>			
código	694815	referencia	25725607/0 CM25725607/0
descripción	soporte L 128mm An 90mm H 30mm plástico		

			
1			
código	694816	referencia	25725606/0 CM25725606/0
descripción	soporte L 243mm An 149mm H 40mm plástico		

			
1			
código	695715	referencia	25620289/0 CM25620289/0
descripción	soporte para máquina de hielo L 515mm An 70mm		

			
1			
código	691665	referencia	25726470/0 25726473/0 CM25726470/0 CM25726473/0
descripción	soporte para tapa evaporador		
Para modelos:	N131M, N200M, N200MW, N201M, N300M, N300MW, N301M, N401M, N500M, N501M		

			
1			
código	692612	referencia	19690418/0 CM19690418/0
descripción	tapa H 12mm int.ø 38mm ø ext. 44mm		

			
1			
código	695733	referencia	CF66050700 CMCF66050700
descripción	tapa para máquina de hielo H 18mm int.ø 56mm ø ext. 61mm		
Para modelos:	SF300, SF500, SFN1000, SFN1000W		

			
1			
código	695675	referencia	25730502/0 CM25730502/0
descripción	tapa terminal para dispensador de agua H 19mm int.ø 16mm ø ext. 27mm pos. de montaje derecho		

			
1			
código	696614	referencia	25728007/0 CM25728007/0 CMNM66074100
descripción	tapón para máquina de hielo H 40mm int.ø 83mm ø ext. 88mm		

			
1			
código	691807	referencia	25730503/0 CM25730503/0
descripción	tapón de desagüe para contenedor agua L 12mm ø 12mm		
Para modelos:	N131M, N200M, N200MW, N201M, N300M, N300MW, N301M, N401M, N500M, N501M		

			
1			
código	695660	referencia	25300000/0 CM25300000/0
descripción	tubo de entrada para máquina de hielo ICEMATIC		
Para modelos:	N20L, N20WL, N25BI, N25L, N25LBI, N25LW, N25S, N25SW, N35BI, N35S, N35SW, N45L, N45S, N45SW, N50BI, N50BIW, N55L, N55LW, N55S, N55SW, N70S, N70SW, N90L, N90LW, N90S, N90SW		

			
1			
código	695730	referencia	29090000/0 CM29090000/0
descripción	tubo nivel de agua para máquina de hielo L 20mm An 19mm H 130mm		

			
1			
código	695046	referencia	19305022/0 CF66053500 CM19305022/0 CMCF66053500 nicht in Preisliste
descripción	tuerca H 5mm rosca M24x1,5 plástico		
Para modelos:	F100, F120, F125C, F200, F80C, F80WC, N21S, SF300, SF500		



1

código	695734	referencia	25360200/0 CM25360200/0
descripción	tuerca de racor H 15mm ø ext. 46mm		

válvulas

válvulas de llenado



1

código	695685	referencia	19864010/0 19864011/0 CM19864010/0 CM19864011/0
descripción	válvula de llenado rosca M11 L 130mm ø 37mm plástico		
Para modelos:	N200M, N200MW, N300M, N300MW, N500M		

para contenedores de hielo

tapa



1

código	696389	referencia	81430351/0 81460351/0 CM81430351/0 CM81460351/0
descripción	tapa para contenedor de hielo L 720mm An 300mm H 23mm		
Para modelos:	D201		

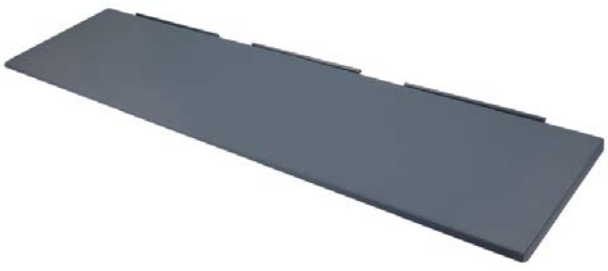

1

código	696382	referencia	81460239/0 CM81460239/0
descripción	tapa para contenedor de hielo para modelo D 310 L 1050mm An 280mm H 30mm		
Para modelos:	D310		



1

código	696426	referencia	81460183/0 CM81460183/0
descripción	tapa para contenedor de hielo para modelo D200 L 768mm An 294mm H 25mm		

marcos



1

código	695664	referencia	81460341/0 CM81460341/0
descripción	marco para contenedor de hielo L 565mm An 465mm H 70mm para modelo D 100		



1

código	696381	referencia	81460056/0 CM81460056/0
descripción	marco para contenedor de hielo L 810mm An 465mm H 70mm para modelo D 200		



1

código	696657	referencia	81460378/0 CM81460378/0
descripción	marco para contenedor de hielo para modelo D 101 L 570mm An 500mm H 70mm		
Para modelos:	D101		

puertas



1

código	696582	referencia	81460355/0 CM81460355/0
descripción	puerta para modelo B390/B393 L 767mm An 28mm H 310mm		

accesorios para 696582

	código	508418	referencia	19350201/0 CM19350201/0
	junta de gomaespuma An 15mm espesor 8mm autoadhesivo UE 1m			

para cámaras de fermentación

sistemas de mangueras de desagüe



1

código	698602	referencia	400UMSIF01 CM400UMSIF01
descripción	sifón PVC flexible ø 20mm L 33/21mm codo		

generadores de vapor



1

código	698572	referencia	400UMCL04 CM400UMCL04
descripción	humidificador tipo 400UMCL04 H 195mm ø 209mm conductividad 250-1300µS/cm² fases 3 con junta		



1

código	698570	referencia	400UMCL01 CM400UMCL01
descripción	humidificador tipo 400UMIVALV H 245mm ø 201mm conductividad 250-1300µS/cm² fases 3 con junta		



1

código	698569	referencia	19120427/0 CM19120427/0 F401TA0000
descripción	humidificador tipo F401TA0000 H 300mm ø 150mm conductividad 125-1250µS/cm ² fases 1 con junta		



1

código	698568	referencia	19120431/0 CM19120431/0 L401TA0000
descripción	humidificador tipo L401TA0000 H 28mm ø 160mm conductividad 125-1250µS/cm ² fases 1 con junta		



1

código	698567	referencia	19120429/0 CM19120429/0 L201MA0000
descripción	humidificador tipo L201MA0000 H 28mm ø 160mm conductividad 125-1250µS/cm ² fases 1 con junta		

manillas y volantes

manillas en forma de estrella



1

código	698606	referencia	19950003/0 CM19950003/0
descripción	manilla en forma de estrella rosca M4 ø 25.3mm L 16.5mm negro		

asas de arco



1

código	700989	referencia	28190005/0 CM28190005/0
descripción	asa de arco L 325mm H 16mm distancia de sujeción 254mm An 36.5mm cromado		

accesorios para	700989		
	código	692526	referencia
			28040018 28040018/0 CM28040018/0
	cubierta para asidero plástico		

cubiertas



1

código	692526	referencia	28040018 28040018/0 CM28040018/0
descripción	cubierta para asidero plástico		

sujeciones

tornillos de retención



1

código	697742	referencia	19950006/0 CM19950006/0
descripción	tornillo de retención rosca M4 asidero ø 17mm negro L 10mm		



1

código	697519	referencia	19950004/0 CM19950004/0
descripción	tornillo de retención rosca M5 asidero ø 21mm negro L 10mm		

empuñaduras



1

código	695721	referencia	28000096/0 CM28000096/0
descripción	empuñadura L 330mm An 44mm H 96mm		

MANILLAS Y VOLANTES/BISAGRAS ICEMATIC

bisagras

bandas de bisagras

específico del fabricante

CASTEL

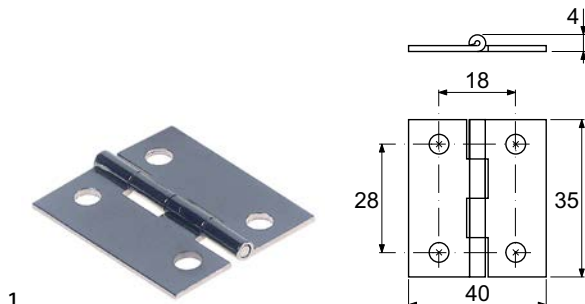

1

código	691804	referencia	19120050/0 CM19120050/0
descripción	bisagra L 40mm An 35mm H 4mm distancia de sujeción 28mm agujero ø 5mm espesor 1.3mm latón ICEMATIC		
Para modelos:	F100C, F125C, F80C, F80WC, N20L, N20WL, N25BI, N25L, N25LBI, N25LW, N25S, N25SW, N35BI, N35S, N35SW, N45L, N45S, N45SW, N50BI, N50BIW, N55L, N55LW, N55S, N55SW, N70S, N70SW, N90L, N90LW, N90S, N90SW		

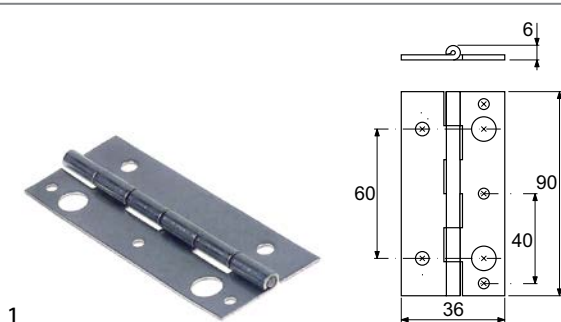

1

código	691805	referencia	25130137/0 CM25130137/0
descripción	bisagra L 90mm An 36mm H 6mm distancia de sujeción 60mm distancia de sujeción 1 40mm distancia de sujeción 2 40mm agujero ø 3/5mm espesor 1.2mm acero inoxidable		
Para modelos:	D101, D201		



1

código	701030	referencia	19120045/0 CM19120045/0
descripción	bisagra regulable L 43mm An 37mm agujero ø 4mm para contenedor de hielo distancia de sujeción 26/32mm plástico		



bisagras de resorte

universal

CAFF/FERMOD

grupo 2



1

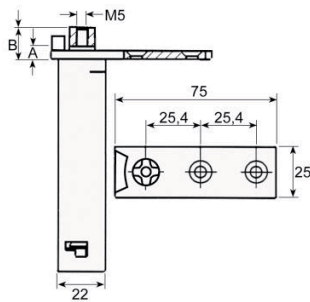

código	690494	referencia	19120054/0 CM19120054/0
descripción	bisagra a resorte serie 175 pos. de montaje izquierdo/derecho torx L 75mm An 25.6mm H 100mm A 4mm B 11mm medida de montaje 22x22mm soporte torx aparatos de refrigeración distancia de sujeción 25mm		

soporte de puerta



1

código	690583	referencia	28294982/0 28294990/0 CM28294982/0 CM28294990/0
descripción	cojinete giratorio sin perno		

otros



1

código	695727	referencia	25130130/0 CM25130130/0
descripción	bisagra		

filtros

filtros de aire

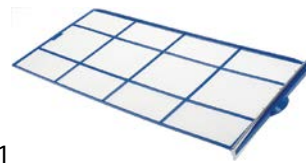

1

código	970890	referencia	81400187/0 CM81400187/0
descripción	filtro de aire L 540mm An 250mm H 6mm		
Para modelos:	N25LBI, N35BI		

filtros para aparatos



1

código	970877	referencia	25339013/0 CM25339013/0
descripción	filtro de aire L 335mm An 238mm H 3mm plástico para máquina de hielo		

pies para aparatos y tapas terminales

pies para aparatos

con fijación atornillada

universal



1

código	701458	referencia	25570707/0 CM25570707/0
descripción	pie de aparato tubo ø 52mm rosca M10 rosca L 25mm H 104-115mm acero inoxidable medida 2" UE 1 pzs		

piezas sueltas



1

código	701093	referencia	25570880/0 CM25570880/0
descripción	pie de aparato tubo ø 47mm H 68mm plástico rosca 1/4" M		
Para modelos:	F100C, F125C, N140, N45L, N45S, N45SW, N55L, N55LW, N55S, N55SW, N70S, N70SW, N90L, N90LW, N90S, N90SW		

piezas sueltas



1

código	701093	referencia	25570880/0 CM25570880/0
descripción	pie de aparato tubo ø 47mm H 68mm plástico rosca 1/4" M		
Para modelos:	F100C, F125C, N140, N45L, N45S, N45SW, N55L, N55LW, N55S, N55SW, N70S, N70SW, N90L, N90LW, N90S, N90SW		



1

código	700103	referencia	19490020/0 81502140/0 CM19490020/0 CM81502140/0
descripción	pie de aparato tubo ø 56mm dimensiones de la placamm dist. del agujeromm H 130mm inox medida 2" UE 1 pzs		
Para modelos:	D101, D201, D310		



1

código	700103	referencia	19490020/0 81502140/0 CM19490020/0 CM81502140/0
descripción	pie de aparato tubo ø 56mm dimensiones de la placamm dist. del agujeromm H 130mm inox medida 2" UE 1 pzs		
Para modelos:	D101, D201, D310		

con placa de sujeción



1

código	700823	referencia	81502140/0 CM81502140/0
descripción	pie de aparato tubo ø 64mm dimensiones de la placa 80x100mm dist. del agujero 56x78mm H 130-185mm inox medida 2 1/2" UE 1 pzs		



1

código	691803	referencia	81400690/0 95000100/0 CM81400690/0 CM95000100/0
descripción	pie de aparato tubo ø 68mm dimensiones de la placa 45x50mm dist. del agujeromm H 175-190mm plástico UE 1 pzs		



1

código	695917	referencia	25460020/0 CM25460020/0
descripción	pie de aparato tubo ø 63mm dimensiones de la placamm dist. del agujeromm H 100mm plástico medida 2 1/3" UE 1 pzs		
Para modelos:	F100C, F125C, N140, N25L, N25LBI, N25LW, N35BI, N35S, N35SW, N45S, N45SW, N55L, N55LW, N55S, N55SW, N70S, N70SW, N90L, N90LW, N90S, N90SW		



otros



1			
código	695677	referencia	25570870/0 CM25570870/0
descripción	pie de aparato tubo ø 46/68mm H 175-190mm plástico rosca 1¼" H		
Para modelos:	N25L, N25LBI, N25LW, N35BI, N35S, N35SW		

pies enroscables



1			
código	695738	referencia	81502119/0 CM81502119/0
descripción	pie de aparato rosca M8 rosca L 27mm ø 30mm H 12mm UE 1 pzs		
Para modelos:	F80C, F80WC, N25L, N25LBI, N25LW, N35BI, N35S, N35SW, N45L		

tapas terminales y tapones

para tubos cuadrados

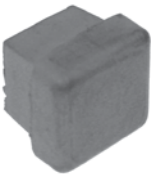

1			
código	695068	referencia	25728011/0 CM25728011/0
descripción	tapa terminal para máquina de hielo agujero inserto 13x13mm		
Para modelos:	N21S		

otros



1			
código	695722	referencia	81400690/0 CM81400690/0
descripción	chapa de montaje rosca 1¼" L 55mm An 50mm H 27mm agujero ø 9.5mm		
Para modelos:	N25L, N25LBI, N25LW, N35BI, N35S, N35SW		

rejillas y rieles guía

parrillas

universal

sin reborde



1			
código	970689	referencia	26107225/0 CM26107225/0
descripción	parrilla An 325mm P 530mm GN 1/1 acero inoxidable		

con reborde



1			
código	970556	referencia	28174022 28174028 28174028/0 CM28174028/0

descripción parrilla An 530mm P 650mm GN 2/1 acero plastificado con tope anillo externo reforzado 9mm refuerzos longitudinales 5mm traviesas 2 blanco apto para refrigerador

accesorios para	970556		
código	690330	referencia	—

cremallera L 1000mm An 22mm H 4mm tamaño orificio 3x8mm dist. del agujero 12.5mm acero inoxidable

código	690332	referencia	—
descripción	soporte de bandeja L 31/28mm An 22mm H 17mm inox con gancho UE 1 pzs		

código	694700	referencia	—
descripción	soporte de bandeja L 31/28mm An 22mm H 18mm inox UE 12 pzs		

código	694701	referencia	—
descripción	soporte de bandeja L 31/28mm An 22mm H 17mm inox con gancho UE 12 pzs		

rieles guía y soportos

específico del fabricante



1			
código	695908	referencia	98000700/1 CM98000700/1
descripción	par de barras de ajuste forma U L 620mm An 15mm altura interior 22mm		

juntas

juntas para frigoríficos

juntas insertables

perfil 9048

Fabricamos burlletes personalizables de este perfil

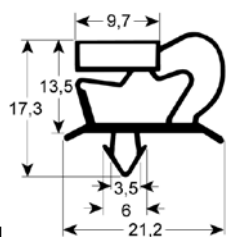

código 901970 **referencia** 26100379/0
CM26100379/0

descripción junta para frigorífico perfil 9048 An 1130mm L 755mm medida inserción

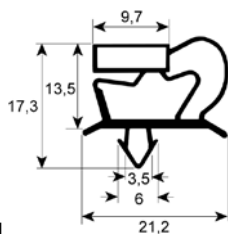

código 901218 **referencia** 19352024
19352024/0
CM19352024/0

descripción junta para frigorífico perfil 9048 An 301mm L 367mm medida inserción para abatidor de temperatura

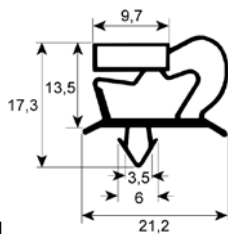

código 901217 **referencia** 26107202
26107202/0
CM26107202/0

descripción junta para frigorífico perfil 9048 An 395mm L 711mm medida inserción para abatidor de temperatura

Para modelos: T5

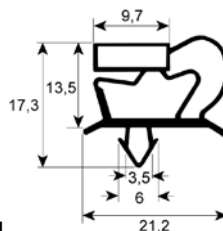

1

código 901216 **referencia** 26107203
26107203/0
CM26107203/0

descripción junta para frigorífico perfil 9048 An 705mm L 1030mm medida inserción para abatidor de temperatura

Para modelos: T14

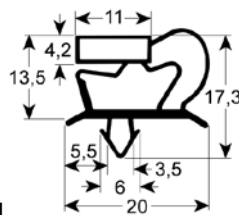

1

código 902442 **referencia** CM26100291/0

descripción junta para frigorífico perfil 9048 An 751mm L 766mm medida inserción UE 1 congelador instantáneo

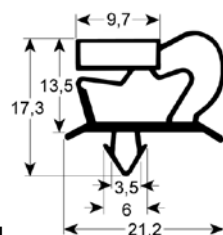

1

código 901969 **referencia** 26103838/0
CM26103838/0

descripción junta para frigorífico perfil 9048 An 752mm L 395mm medida inserción

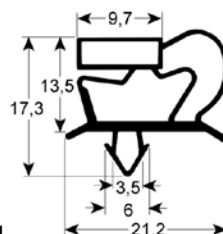

1

código 901973 **referencia** 19350510/0
CM19350510/0

descripción junta para frigorífico perfil 9048 An 875mm L 715mm medida inserción

perfil 9773

Fabricamos burletes personalizables de este perfil

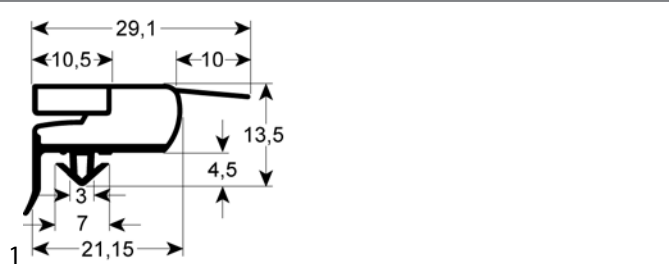

código	901089	referencia	CM4612038
descripción	junta para frigorífico perfil 9773 An 640mm L 1540mm medidas exteriores B1 627mm L1 1527mm medida inserción		

perfil 9704

Fabricamos burletes personalizables de este perfil

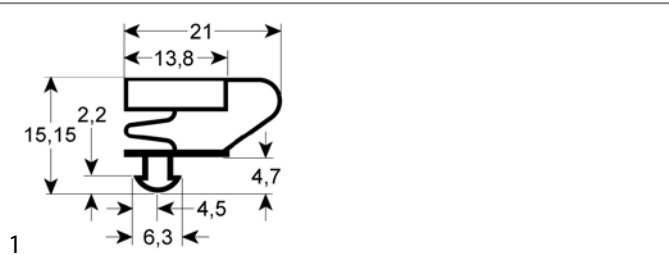

código	901974	referencia	19352010/0 CM19352010/0
descripción	junta para frigorífico perfil 9704 An 605mm L 475mm medida inserción		

perfil 9151

Fabricamos burletes personalizables de este perfil

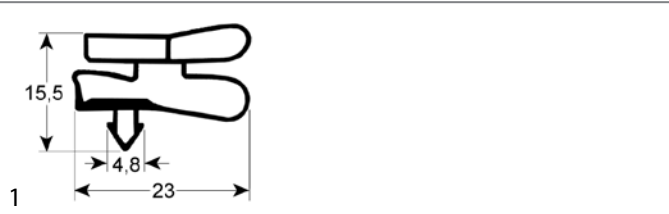

código	900878	referencia	28175018/0 CM28175018/0
descripción	junta para frigorífico perfil 9151 An 705mm L 770mm rectangular		



código	900368	referencia	28175017/0 CM28175017/0
descripción	junta para frigorífico perfil 9151 An 715mm L 1580mm medida inserción L1 1570mm B1 705mm medidas exteriores		

perfil 9251

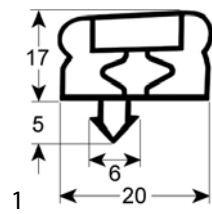

código	901972	referencia	19350506/0 CM19350506/0
descripción	junta para frigorífico perfil 9251 An 1000mm L 2750mm medida inserción 3 lados		

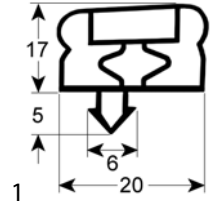

código	901971	referencia	19350157/0 CM19350157/0
descripción	junta para frigorífico perfil 9251 An 850mm L 662mm medida inserción		

otros



código	902010	referencia	19550126/0 CM19550126/0
descripción	junta junta insertable tamaño 7x13		

juntas tóricas

EPDM

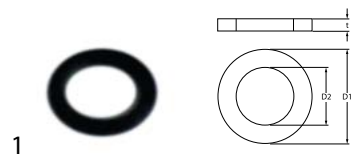

código	528485	referencia	CF64010000 CMCF64010000
descripción	junta tórica EPDM espesor 1.78mm int.ø 6.07mm UE 1 pzs		
Para modelos:	F100, F120, F125C, F200, F80C, F80WC, SF300, SF500, SFN1000, SFN1000W		

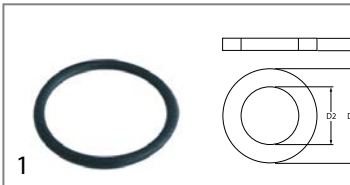

código	510769	referencia	CF64004101 CMCF64004101
descripción	junta tórica EPDM espesor 2.62mm int.ø 25.07mm UE 1 pzs		
Para modelos:	F100, F100C, F120, F125C, F200, F80C, F80WC		

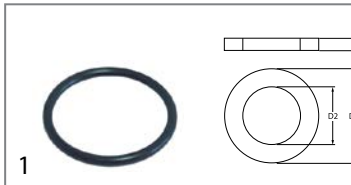

código	510895	referencia	29000023 CF64009302 CMCF64009302
descripción	junta tórica EPDM espesor 3.53mm int.ø 34.52mm UE 1 pzs		
Para modelos:	SF300, SF500, SFN1000, SFN1000W		

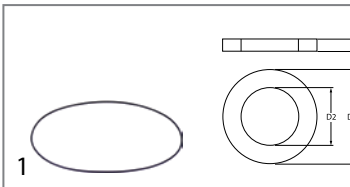

código	528094	referencia	CF64008400 CMCF64008400
descripción	junta tórica EPDM espesor 2mm int.ø 171mm UE 1 pzs		
Para modelos:	F100, F100C, F120, F125C, F80C, F80WC		

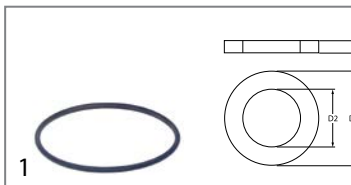

código	532534	referencia	29000002/0 CM29000002/0
descripción	junta tórica EPDM espesor 3.53mm int.ø 82.14mm UE 1 pzs		



código	361085	referencia	41020448 41020448/0 CM41020448/0
descripción	junta tórica EPDM espesor 2mm int.ø 8mm UE 1 pzs		
Para modelos:	N200M, N200MW, N300M, N300MW, N500M		

silicona

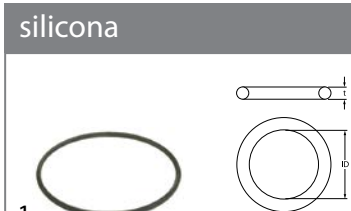

código	695064	referencia	29000022 CF64004120 CMCF64004120
descripción	junta tórica silicona espesor 2mm int.ø 66.4mm UE 1 pzs		

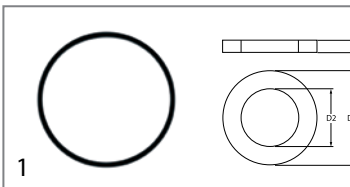

código	510009	referencia	CF64009303 CMCF64009303
descripción	junta tórica EPDM espesor 3.53mm int.ø 101.2mm UE 1 pzs		
Para modelos:	SF300, SF500, SFN1000, SFN1000W		

Viton

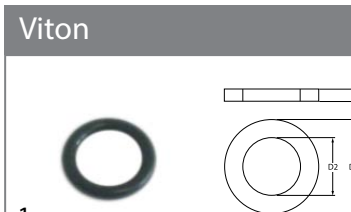

código	528250	referencia	I-1087
descripción	junta tórica Viton espesor 2mm int.ø 8mm UE 1 pzs		

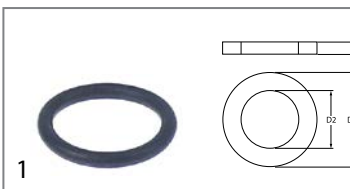

código	517087	referencia	19035151/0 CM19035151/0
descripción	junta tórica EPDM espesor 3.53mm int.ø 23.4mm UE 1 pzs		
Para modelos:	N21S		

NBR

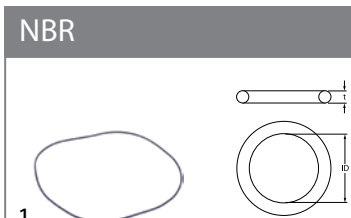

código	697879	referencia	1300061738 CM1300061738
descripción	junta tórica NBR espesor 2.62mm int.ø 219mm UE 1 pzs		
Para modelos:	SF300, SF500		

anillos de junta

juntas de goma



1

código	510764	referencia	19350158/0 CM19350158/0
descripción	junta plana goma ø ext. 24mm int.ø 12mm espesor 2mm UE 1 pzs		
Para modelos:	N20L, N20WL, N25L, N25LW, N25SW, N35S, N35SW, N45L, N45S, N45SW, N55L, N55LW, N55S, N55SW, N70S, N70SW, N90L, N90LW, N90S, N90SW		

juntas de gomaespuma



1

código	691329	referencia	19535169/0 CM19535169/0
descripción	junta de gomaespuma An 10mm espesor 5mm autoadhesivo UE al metro		



1

código	508418	referencia	19350201/0 CM19350201/0
descripción	junta de gomaespuma An 15mm espesor 8mm autoadhesivo UE 1m		



1

código	695758	referencia	nicht in Preisliste
descripción	junta de gomaespuma An 15mm espesor 8mm autoadhesivo UE 3m perfil semirredondo		



1

código	901292	referencia	nicht in Preisliste enthalten
descripción	junta de gomaespuma An 15mm espesor 8mm autoadhesivo UE al metro		



1

código	693787	referencia	19352049/0 CM19352049/0
descripción	junta de gomaespuma ø 6mm UE al metro		

juntas de árbol

juntas de árbol



1

código	698239	referencia	29040001 CF64008300 CMCF64008300
descripción	junta radial int.ø 11.91mm ø ext. 18.24mm espesor 5mm		
Para modelos:	F100, F100C, F120, F125C, F80C, F80WC		



1

código	511532	referencia	CF02160600 CM02001606 CMCF02160600
descripción	junta radial int.ø 15mm ø ext. 25.5mm espesor 6.5mm para máquina de hielo en cubitos		
Para modelos:	SF300, SF500, SFN1000, SFN1000W		



1

código	511534	referencia	64001901 CF02160700 CF64001901 CMCF02160700 CMCF64001901
descripción	junta radial int.ø 22mm ø ext. 32mm espesor 5.5mm		
Para modelos:	F100, F100C, F120, F125C, F200, F80C, F80WC		



1

código	511533	referencia	CF02285301 CMCF02002853 CMCF02285301
descripción	junta radial int.ø 25mm ø ext. 34mm espesor 5mm para máquina de hielo		
Para modelos:	SF300, SF500, SFN1000, SFN1000W		

juntas especiales

para máquina de hielo en cubitos



código	901968	referencia	19350507/0 CM19350507/0
descripción	junta de puerta para máquina de hielo en cubitos L 515mm An 45mm espesor 10mm silicona		

para envasadoras al vacío



código	693787	referencia	19352049/0 CM19352049/0
descripción	junta de gomaespuma ø 6mm UE al metro		

componentes para el circuito frigorífico

controladores de agua de refrigeración

JOHNSON CONTROLS



código	541189	referencia	19865611/0 CM19865611/0
descripción	regulador de agua de refrigeración 3/8" tipo V46AA-9608 empalme 7/16" UNF (1/4" SAE) margen de presión Mai 18bar pres.máx.agua 10bar temp.máx.agua 90°C capilar 750mm L 160mm 0.9kg		
Para modelos:	F100C, F125C, N131M, N140, N200MW, N201M, N300MW, N301M, N401M, N45S, N45SW, N500M, N501M, N50BI, N50BIW, N70SW, N90LW, N90SW		

código	541483	referencia	19870815/0 29087021/0 CF62011100 CM19870815/0 CM29087021/0 CMCF62011100
descripción	regulador de agua de refrigeración 3/8" tipo V46AA-9950 empalme 6mm conexión para soldadura margen de presión Mai 18bar pres.máx.agua 10bar temp.máx.agua 90°C capilar 750mm L 160mm 0.9kg		
Para modelos:	F100, F120, F200, N20L, N20WL, SF300, SF500, SFN1000W		

válvulas

válvulas de expansión

DANFOSS

válvulas

tipo TS2/TES2



código	750178	referencia	19870826/0 CM19870826/0
descripción	válvula de expansión DANFOSS tipo TS2 refrigerante R404a/R507 acodado 90° entrada 3/8" SAE salida 1/2" SAE compensación presión p máx. 28bar -40 a -5°C capilar 1500mm		
Para modelos:	N200M, N200MW, N300M, N300MW		



código	750530	referencia	81453620/0 CM81453620/0
descripción	válvula de expansión DANFOSS tipo TS2 refrigerante R404a/R507 acodado boquilla 068-2006 entrada 3/8" SAE salida 1/2" SAE compensación presión p máx. 34bar -30 a +10°C capilar 1500mm		
Para modelos:	N201M, N301M, N500M		



código	750545	referencia	81453840/0 CM81453840/0
descripción	válvula de expansión DANFOSS tipo TS2 refrigerante R404a/R507 acodado boquilla 068-2008 entrada 3/8" SAE salida 1/2" SAE compensación presión p máx. 34bar -30 a +10°C capilar 1500mm		
Para modelos:	N501M		



			
1			
código	750529	referencia	81453621/0 CM81453621/0
descripción	válvula de expansión DANFOSS tipo TS2 refrigerante R404a/R507 acodado boquilla 068-2015 entrada 3/8" SAE salida 1/2" SAE compensación presión p máx. 34bar -30 a +10°C capilar 1500mm		
Para modelos:	N131M		

tipo TUA/TUB/TUC			
			
1			
código	750531	referencia	19870401/0 CM19870401/0
descripción	válvula de expansión DANFOSS tipo TUC refrigerante R404a/R507 recto entrada 6mm conexión para soldadura salida 10mm conexión para soldadura compensación presión p máx. 34bar -30 a +10°C capilar 800mm		

			
1			
código	750532	referencia	19870312/0 CM19870312/0
descripción	válvula de expansión DANFOSS tipo TUC refrigerante R404a/R507 recto entrada 6mm conexión para soldadura salida 13mm conexión para soldadura compensación presión p máx. 34bar -25 a +10°C capilar 800mm		

unidades de boquillas			
			
1			
código	750484	referencia	19470964/0 CM19470964/0
descripción	complmento de boquilla tamaño 05 tipo 068-2008 T2/TE2 DANFOSS		

HONEYWELL			
válvulas			
			
1			
código	750425	referencia	19870622/0 19870627 19870627/0 CM19870622/0 CM19870627/0
descripción	válvula de expansión HONEYWELL tipo TMV-00001 refrigerante R22 acodado 90° controlado por termostato entrada 5/8" UNF (3/8" SAE) salida 3/4" UNF (1/2" SAE) compensación presión -45 a +15°C		

filtros deshidratadores antiácidos			
GMC			
			
1			
código	750086	referencia	19300357/0 CM19300357/0
descripción	deshidratador tipo SC032S empalme ODF 1/4"-ODM 3/8" 50cm ³ p máx. 45bar -40 a +80°C 261g longitud 95mm ø 57.5mm		
Para modelos:	N131M, N140, N201M, N301M		

			
1			
código	750525	referencia	19301257/0 CM19301257/0
descripción	deshidratador tipo SC053M10S empalme ODF 10mm-ODM 12mm 80cm ³ p máx. 45bar -40 a +80°C 325g longitud 109mm ø 57.5mm		
Para modelos:	N200M, N200MW, N300M, N300MW, N301M		



1

código	750526	referencia	19300355/0 CM19300355/0
descripción	deshidratador tipo SC083M10S empalme ODF 10mm-ODM 12mm 130cm ³ p máx. 45bar -40 a +85°C 399g longitud 134mm ø 57.5mm		
Para modelos:	N200M, N200MW, N300M, N300MW, N401M, N500M, N501M		

otros



1

código	750068	referencia	63000303
descripción	deshidratador tamaño 25g ø 24mm L 140mm empalme 3,5/7mm		

evaporadores

para frigoríficos

específico del fabricante



1

código	750698	referencia	19270072/0
descripción	evaporador		
Para modelos:	T5		



1

código	694180	referencia	191477077/0 CM191477077/0
descripción	evaporador L 525mm An 50mm H 442mm		

para máquina de hielo en cubitos

para máquina de hielo en cubitos



1

código	750127	referencia	81402037/0 CM81402037/0
descripción	evaporador para máquina de hielo en cubitos 15 cubitos L 185mm An 155mm H 60mm longitud total 400mm anchura total 225mm altura total 115mm		
Para modelos:	N20L, N20WL		



1

código	750128	referencia	81412031/0 CM81412031/0
descripción	evaporador para máquina de hielo en cubitos 35 cubitos L 295mm An 185mm H 60mm altura total 130mm		
Para modelos:	N45L, N45S, N45SW, N50BI, N50BIW, N55L, N55LW, N55S, N55SW		

para fabricante de hielo en escamas



1

código	695712	referencia	I-1721
descripción	evaporador para fabricante de hielo en escamas An 180mm H 225mm ø 90mm		
Para modelos:	F100		



1

código	695751	referencia	CF79423704 CF79423706 CMCF79423704 CMCF79423705 CMCF79423706 CMCF79423706R
descripción	evaporador para fabricante de hielo en escamas Anmm H 375mm ø 73mm		
Para modelos:	F200		



1

código	691796	referencia	nicht in Preisliste
descripción	filtro de aire para condensador L 495mm An 270mm		

accesorios

carcasas



1

código	696383	referencia	25820123/0 CM25820123/0
descripción	tapa para evaporador para máquina de hielo para N120 L 422mm An 336mm H 60mm		
Para modelos:	N131M		



1

código	692589	referencia	25339007/0 CM25339007/0
descripción	filtro de aire para condensador L 510mm An 313mm H 6mm		
Para modelos:	N131M		

condensadores

filtros



1

código	695736	referencia	25339006/0 CM25339006/0
descripción	filtro para condensador L 510mm An 410mm H 6mm		
Para modelos:	N201M, N301M		

condensadores



1

código	750087	referencia	19177509/0 CM19177509/0
descripción	condensador An 190mm P 60mm H 200mm		
Para modelos:	N20L, N20WL, N25BI, N25S, N25SW		



1

código	750088	referencia	19180085/0 CM19180085/0
descripción	condensador An 280mm P 70mm H 230mm		



1

código	750125	referencia	CF62043900 CMCF62043900
descripción	condensador An 290mm P 85mm H 260mm		
Para modelos:	F100, F120		

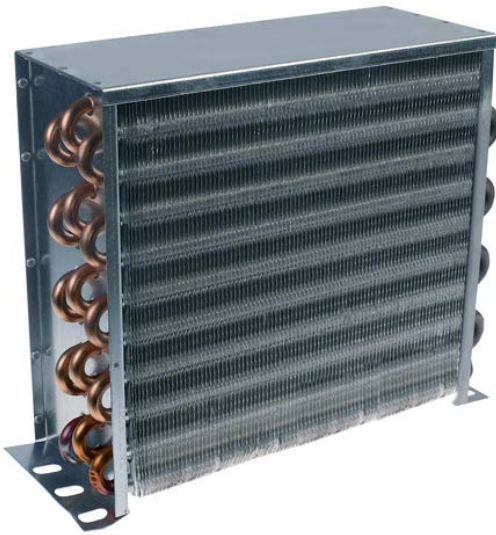

1

código	750122	referencia	29015035/0 62040500 CF62040500 CM29015035/0 CMCF62040500
descripción	condensador An 290mm P 120mm H 270mm		
Para modelos:	F200		



1

código	750089	referencia	29015033/0 CF62027602 CM29015033/0 CMCF62027602
descripción	condensador para máquina de hielo An 280mm P 46mm H 230mm		
Para modelos:	F100, F120		



código	750527	referencia	19177073/0 CM19177073/0
descripción	condensador para máquina de hielo An 525mm P 62mm H 490mm		
Para modelos:	N201M		



código	750451	referencia	19177072/0 CM19177072/0
descripción	condensador para máquina de hielo An 530mm P 80mm H 550mm		
Para modelos:	N301M		



código	750092	referencia	19177507/0 CM19177507/0
descripción	condensador para máquina de hielo An 550mm P 70mm H 455mm		
Para modelos:	N200M, N200MW, N300M, N300MW		



código	750090	referencia	19177058/0 CM19177058/0
descripción	condensador para máquina de hielo An 665mm P 113mm H 285mm		
Para modelos:	N140		

condensadores refrigerados por agua



1	código	695718	referencia	81407536/0 CM81407536/0
	descripción	condensador para máquina de hielo An 190mm H 220mm L 100mm		
	Para modelos:	N25SW		

bandejas de agua condensada y cubetas de evaporación

bandejas de agua condensada



1	código	694179	referencia	26105003/0 CM26105003/0
	descripción	bandeja de agua condensada L 520mm An 320mm H 50mm para congelador rápido		
	Para modelos:	T14, T5		



1	código	695916	referencia	28300013/0 CM28300013/0
	descripción	bandeja de agua condensada para frigorífico L 680mm An 325mm H 40mm		

muelles

muelles de torsión



1	código	695021	referencia	25474600/0 CM25474600/0
	descripción	resorte de torsión ø 20.8mm L1 23.2mm L2 37mm espesor de hilo 2.3mm para máquina de hielo		
	Para modelos:	N20L, N20WL, N25BI, N25L, N25LBI, N25LW, N25S, N25SW, N35BI, N35S, N35SW		



1	código	695022	referencia	25474602/0 CM25474602/0
	descripción	resorte de torsión ø 21.2mm L1 26mm L2 37mm espesor de hilo 2.6mm para máquina de hielo		
	Para modelos:	N45L, N45S, N45SW, N50BI, N50BIW, N55L, N55LW, N55S, N55SW, N70S, N70SW, N90L, N90LW, N90S, N90SW		



1	código	695676	referencia	25474601/0 CM25474601/0
	descripción	resorte de torsión ø 23.5mm L1 29mm L2 38mm espesor de hilo 3mm para máquina de hielo		
	Para modelos:	N140		

resortes de tracción



1	código	695674	referencia	25475400/0 CM25475400/0
	descripción	muelle de tracción para cubeta ø 13mm espesor de hilo 1.7mm L1 80mm		
	Para modelos:	N140		



tubos flexibles

tubos de salida

			
1			
código	530473	referencia	19810114/0 CM19810114/0
descripción	manguera de desagüe DN19 L 1900mm ø int. recta 19mm ø ext. recto 25mm dim.ext. codo 23mm ø ext. codo 27mm tubo ø ext. 24mm para máquina de hielo		
Para modelos:	F100C, F125C, F80WC, N131M, N140, N200M, N200MW, N201M, N20L, N20WL, N25BI, N25SW, N300M, N300MW, N301M, N401M, N501M, N55L, N55LW, N55S, N55SW, N70S, N70SW, N90L, N90LW, N90S, N90SW		

tubos flexibles industriales

tubos de silicona

sin tejido

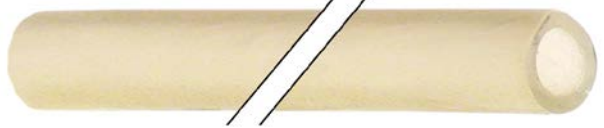
			
1			
código	530769	referencia	25790880/0 CM25790880/0
descripción	tubo de silicona para máquina de hielo en cubitos int.ø 14mm ø ext. 20mm L 650mm		

guarniciones, empalmes para mangueras y tubos



guarniciones

boquillas dobles

			
1			
código	520447	referencia	73320400 CF73320400 CMCF73320400
descripción	boquilla doble rosca 3/8" - 3/4" L1 24mm L2 12mm		
Para modelos:	F100, F120, F200, SF300, SF500, SFN1000W		

empalmes de tubo

específico del fabricante

			
1			
código	695737	referencia	25631035/0 CM25631035/0
descripción	empalme de tubo recto plástico L 60mm ø 20mm		
Para modelos:	N21S		
			
1			
código	695050	referencia	25690803 25690806/0 CM25690806/0
descripción	empalme de tubo recto plástico L 70mm ø 21mm		
Para modelos:	F100C, F125C, F80C, F80WC, N200M, N200MW, N20L, N20WL, N25BI, N25L, N25LW, N25S, N25SW, N300M, N300MW, N35S, N35SW, N45L, N45S, N45SW, N500M, N55L, N55LW, N55S, N55SW, N70S, N70SW, N90L, N90LW, N90S, N90SW		

			
1			
código	361796	referencia	nicht in Preisliste
descripción	empalme de tubo rosca 3/4" M boquilla ø 13.5mm int.ø 10mm longitud boquilla 20mm EC 27 rosca L 22mm		

			
1			
código	501340	referencia	25690807/0 CM25690807/0
descripción	pieza de empalme recto plástico ø 22mm		
Para modelos:	F80C, F80WC, N131M, N201M, N25LBI, N301M, N35BI, N401M, N501M		

racores para tubería

JOHN GUEST

			
1			
código	440561	referencia	CM2521375 CMCM2521375
descripción	racor para tubería John Guest recto rosca 1/8" BSP empalme de tubo ø8mm		
accesorios para	440561		
	código	520972	referencia
	tubo flexible John Guest grosor de la pared 1mm LLDPE azul int.ø 6mm ø ext. 8mm		



1

código	520452	referencia	CM2521366 CMCM2521366
descripción	racor para tubería John Guest recto rosca 7/16" UNS empalme de tubo 5/16" junta cónico		

material auxiliar

abrazaderas

abrazaderas de tubo

DIN 3017 - W4



1

código	520444	referencia	nicht in Preisliste enthalten
descripción	abrazadera de tubo inox W4 ø Nov 19mm ancho 9mm UE 1 pzs DIN 3017		

abrazaderas de alambre doble



1

código	520449	referencia	nicht in der Preisliste
descripción	abrazadera de tubo ø 22mm espesor de hilo 3mm UE 1 pzs		



1

código	520407	referencia	19281324/0 CM19281324/0
descripción	abrazadera de tubo ø 26mm espesor de hilo 2.5mm UE 1 pzs		
Para modelos:	N45L, N45S, N45SW, N55L, N55LW, N55S, N55SW, N70S, N70SW, N90L, N90LW, N90S, N90SW		



1

código	520406	referencia	19281332/0 CM19281332/0
descripción	abrazadera de tubo ø 28mm espesor de hilo 2.5mm UE 1 pzs		
Para modelos:	N45S, N45SW, N50BI, N50BIW, N55L, N55LW, N55S, N55SW, N70S, N70SW, N90L, N90LW, N90S, N90SW		

abrazaderas de encaje



1

código	520443	referencia	nicht in Preisliste enthalten
descripción	abrazadera de tubo ø 14-18mm plástico UE 1 pzs ancho 7mm para máquina de hielo		

material de sujeción

tornillos

tornillos de chapa



1

código	560108	referencia	12728106/0 CM12728106/0
descripción	tornillos de chapa ø 4.2mm L 13mm inox UE 20 pzs DIN 7981/ISO 7049 ø cabezal 8.2mm cabeza gota de sebo		
Para modelos:	N140, N20L, N20WL, N90L, N90LW, N90S, N90SW		



1

código	560109	referencia	12728101/0 CM12728101/0
descripción	tornillos de chapa ø 4.2mm L 16mm inox UE 20 pzs DIN 7981/ISO 7049 ø cabezal 8.2mm cabeza gota de sebo		
Para modelos:	N20L, N20WL		





1

código	560059	referencia	12726235/0 CM12726235/0
descripción	tornillo de chapa ø 4.2mm L 38mm inox UE 20 pzs 7983		
Para modelos:	N140		





tornillos de cabeza plana			
			
1			
código	560063	referencia	12726408/0 CM12726408/0
descripción	tornillo de cabeza plana rosca M4 rosca L 16mm inox DIN 7985/ISO 7045 UE 20 pzs soporte Phillips ø cabezal 8mm espesor cabezal 2mm		
Para modelos:	N140		

			
1			
código	560058	referencia	12727301/0 CM12727301/0
descripción	tornillo de cabeza plana rosca M4 rosca L 45mm inox UE 20 pzs soporte Phillips		
Para modelos:	N20L, N20WL, N90L, N90LW, N90S, N90SW		

tuercas hexagonales			
			
1			
código	560453	referencia	CF42391500 CMCF42391500
descripción	tornillo de cabeza hexagonal rosca M12x1,25 rosca L 31mm inox EC 19 UE 1 pzs DIN 933 / ISO 4017		
Para modelos:	SF300, SF500, SFN1000, SFN1000W		

tornillos prisioneros			
			
1			
código	560458	referencia	12712002/0 CM12712002/0
descripción	tornillo prisionero rosca M4 L 5mm soporte ranurado UE 1 pzs		
Para modelos:	N20L, N20WL, N25S, N25SW		

arandelas			
			
1			
código	560093	referencia	CF44180008 CMCF44180008
descripción	arandela int.ø 10mm ø ext. 19mm espesor 0.3mm acero UE 1 pzs		
Para modelos:	F100, F100C, F120, F125C, F80C, F80WC		

			
1			
código	560092	referencia	CF44180007 CMCF44180007
descripción	arandela int.ø 10mm ø ext. 19mm espesor 0.8mm acero UE 1 pzs		
Para modelos:	F100, F100C, F120, F125C, F80C, F80WC		

			
1			
código	560144	referencia	CF03140824 CMCF03140824
descripción	arandela int.ø 13mm ø ext. 22mm espesor 0.8mm acero UE 1 pzs		
Para modelos:	SF300, SF500, SFN1000, SFN1000W		

			
1			
código	560166	referencia	nicht in Preisliste enthalten
descripción	arandela int.ø 16.2mm ø ext. 21mm espesor 0.8mm inox UE 1 pzs		

			
1			
código	560152	referencia	CF44180800 CMCF44180800
descripción	arandela int.ø 23mm ø ext. 29mm espesor 1.5mm acero UE 1 pzs		
Para modelos:	F100, F100C, F120, F125C, F200, F80C, F80WC		

			
1			
código	560568	referencia	CF02167900 CF02168100 CMCF02001681 CMCF02167900 CMCF02168100
descripción	arandela int.ø 25.6mm ø ext. 39mm espesor 0.85mm inox UE 1 pzs		
Para modelos:	SF300, SF500, SFN1000, SFN1000W		

			
1			
código	560074	referencia	CF44180005 CMCF44180005
descripción	arandela int.ø 8.5mm ø ext. 14mm espesor 0.3mm acero UE 1 pzs		
Para modelos:	F100, F100C, F120, F125C, F80C, F80WC		



1

código	560091	referencia	CF44180006 CMCF44180006
descripción	arandela int.ø 8.5mm ø ext. 14mm espesor 0.8mm acero UE 1 pzs		
Para modelos:	F100, F100C, F120, F125C, F80C, F80WC		

sujeciones

clips de fijación



1

código	524029	referencia	19430104/0 CM19430104/0
descripción	clip de sujeción ø nominal 3mm L 26mm An 12mm distancia de sujeción 18mm		

tornillos de fijación



1

código	524030	referencia	nicht in Preisliste enthalten
descripción	perno ø nominal 7mm rosca M4x0,8 L 13mm		

clips para tubo



1

código	695584	referencia	nicht in Preisliste
descripción	grapa elástica L 28mm An 10mm agujero ø 4.5mm tubo ø 31mm		

abrazaderas

abrazaderas de tubo

DIN 3017 - W4



1

código	520444	referencia	nicht in Preisliste enthalten
descripción	abrazadera de tubo inox W4 ø Nov 19mm ancho 9mm UE 1 pzs DIN 3017		

abrazaderas de alambre doble



1

código	520449	referencia	nicht in der Preisliste
descripción	abrazadera de tubo ø 22mm espesor de hilo 3mm UE 1 pzs		



1

código	520407	referencia	19281324/0 CM19281324/0
descripción	abrazadera de tubo ø 26mm espesor de hilo 2.5mm UE 1 pzs		
Para modelos:	N45L, N45S, N45SW, N55L, N55LW, N55S, N55SW, N70S, N70SW, N90L, N90LW, N90S, N90SW		



1

código	520406	referencia	19281332/0 CM19281332/0
descripción	abrazadera de tubo ø 28mm espesor de hilo 2.5mm UE 1 pzs		
Para modelos:	N45S, N45SW, N50BI, N50BIW, N55L, N55LW, N55S, N55SW, N70S, N70SW, N90L, N90LW, N90S, N90SW		

abrazaderas de encaje



1

código	520443	referencia	nicht in Preisliste enthalten
descripción	abrazadera de tubo ø 14-18mm plástico UE 1 pzs ancho 7mm para máquina de hielo		

anillos truarc

DIN 472



1

código	523002	referencia	CF65029700 CMCF65029700 I-1684
descripción	anillo truarc taladro ø 45mm espesor 1.6mm acero DIN 472		
Para modelos:	F100, F100C, F120, F125C, F200, F500, F80C, F80WC		





DIN 6799			
			
código	507015	referencia	CF46003802 CMCF46003802
descripción	anillo truarc E D1 ø 7mm D2 ø 14mm inox DIN 6799 espesor 0.9mm para árbol ø 8-11mm		
Para modelos:	F100, F120, F125C, F200, F80C, F80WC, SF300, SF500, SFN1000, SFN1000W		

pasadores elásticos			
			
código	692013	referencia	12639300/0 CM12639300/0
descripción	pasador elástico ø 3mm L 16mm		
Para modelos:	N140, N20L, N20WL, N25BI, N25L, N25LBI, N25LW, N25S, N25SW, N35BI, N35S, N35SW, N45L, N45S, N45SW, N50BI, N50BIW, N55L, N55LW, N55S, N55SW, N70S, N70SW, N90L, N90LW, N90S, N90SW		

consumibles

lubricantes

lubricantes para máquinas			
			
código	890003	referencia	CF06029401 CMCF06029401
descripción	grasa para máquina 1000g		
descripción			
Para modelos:	F100, F120, F125C, F200, F80C, F80WC, SF300, SF500, SFN1000, SFN1000W		

			
código	890029	referencia	CF06029404 CMCF06029404
descripción	grasa para máquina Mobilux EP004 toma 500g para mecanismo -25 a +120°C		
descripción	<p>Mobilux EP004 - toma 500g</p> <p>Adecuada para lubricar engranajes y cojinetes cerrados en cajas de engranajes de baja estanqueidad, exceptuando los rodamientos de motores eléctricos. También puede utilizarse para muchas otras aplicaciones industriales, como por ej. cajas de engranajes y cadenas, donde los aceites convencionales para engranajes se derramarían de los dispositivos debido a fugas por juntas desgastadas o faltantes. Ha cumplido los requerimientos del ensayo de engranajes SEW 1008 horas, DR.EM.2003 mod.</p> <p>Resistencia a temperaturas: -25°C a +120°C</p>		

			
código	890002	referencia	31415301/0 CF26361200 CM31415301/0 CMCF26361200
descripción	grasa para máquina White Food Grade para alimentos -25 a +150°C homologación NSF 200g		
descripción			
Para modelos:	F100, F120, F125C, F200, F80C, F80WC, SF300, SF500, SFN1000, SFN1000W		

detergentes

descalcificadores

			
código	802164	referencia	nicht in Preisliste enthalten
descripción	descalcificador 4.8l ácido fosfórico para máquina de hielo		