

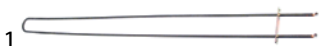

# resistencias

## resistencias para hornos de pizza



<b>código</b>	418173	<b>referencia</b>	74400540 74420540
<b>descripción</b>	resistencia 1000W 230V L 1236mm An 75mm longitud brida 110mm anchura brida 22mm dist. del agujero 94mm longitud de empalme 111mm empalme conector Faston 6,3mm tubo ø 8.5mm espirales 1 brida rectangular agujero ø 6mm resistencia seca		
<b>Para modelos:</b>	RHC 18B, RHC 18C, RHC 18D, RHC 18PB, RHC 18PC, RHC 18PD, RHC 25B, RHC 25C, RHC 25PB, RHC 25PC, RHC 25PD, RHC-25D, RHK - RHC - RHB		



<b>código</b>	418158	<b>referencia</b>	74401130
<b>descripción</b>	resistencia 1005W 115V L 660mm An 88mm longitud brida 124mm anchura brida 30mm dist. del agujero 109mm longitud de empalme 108mm empalme conector Faston 6,3mm tubo ø 8.5mm espirales 1 brida rectangular pos. de montaje arriba agujero ø 5mm resistencia seca		
<b>Para modelos:</b>	PIZZY DUO 105.105, PIZZY MONO 105.105		



<b>código</b>	418165	<b>referencia</b>	74420570
<b>descripción</b>	resistencia 1092W 115V L 603mm An 95mm longitud brida 124mm anchura brida 22mm dist. del agujero 112mm longitud de empalme 122mm empalme conector Faston 6,3mm tubo ø 8.5mm espirales 1 brida rectangular pos. de montaje arriba agujero ø 6mm resistencia seca		
<b>Para modelos:</b>	MHC 18A, MHC 18B, MHC 18C, MHC 30A, MHC 30B, MHC 30C, MHK - MHC - MHB		

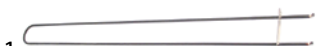

<b>código</b>	418160	<b>referencia</b>	74420600
<b>descripción</b>	resistencia 1275W 115V L 1045mm An 89mm longitud brida 124mm anchura brida 30mm dist. del agujero 107mm longitud de empalme 94mm tubo ø 8.5mm espirales 1 brida rectangular pos. de montaje arriba agujero ø 6.3mm resistencia seca		
<b>Para modelos:</b>	PIZZY DUO 105.105, PIZZY MONO 105.105		



<b>código</b>	418168	<b>referencia</b>	74420590
<b>descripción</b>	resistencia 1275W 115V L 800mm An 94mm longitud brida 124mm anchura brida 30mm dist. del agujero 108mm longitud de empalme 122mm empalme conector Faston 6,3mm tubo ø 8.5mm espirales 1 brida rectangular pos. de montaje arriba agujero ø 6mm resistencia seca		
<b>Para modelos:</b>	MHC 18A, MHC 18B, MHC 18C, MHC 30A, MHC 30B, MHC 30C, MHK - MHC - MHB, PC-18C		

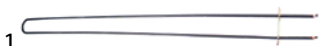

<b>código</b>	418174	<b>referencia</b>	74400550 74420550
<b>descripción</b>	resistencia 1300W 230V L 1235mm An 75mm longitud brida 110mm anchura brida 22mm dist. del agujero 94mm longitud de empalme 110mm empalme conector Faston 6,3mm tubo ø 8.5mm espirales 1 brida rectangular agujero ø 6mm resistencia seca		
<b>Para modelos:</b>	RHC 18D, RHC 18PD, RHC 25PD, RHC-25D, RHK - RHC - RHB		



<b>código</b>	418164	<b>referencia</b>	74420350
<b>descripción</b>	resistencia 400W 110V L 595mm An 95mm longitud brida 104mm anchura brida 22mm dist. del agujero 112mm longitud de empalme 126mm empalme conector Faston 6,3mm tubo ø 8.5mm espirales 1 brida rectangular pos. de montaje abajo agujero ø 6mm resistencia seca		
<b>Para modelos:</b>	MHC 18A, MHC 18PA, MHC 30A, MHC 30PA, MHK - MHC - MHB		



<b>código</b>	418159	<b>referencia</b>	74401140
<b>descripción</b>	resistencia 460W 115V L 657mm An 90mm longitud brida 124mm anchura brida 30mm dist. del agujero 108mm longitud de empalme 109mm empalme conector Faston 6,3mm tubo ø 9.1mm espirales 1 brida rectangular pos. de montaje abajo agujero ø 5mm resistencia seca		
<b>Para modelos:</b>	PIZZY DUO 65.105, PIZZY MONO 65.105		



<b>código</b>	418167	<b>referencia</b>	74420370
<b>descripción</b>	resistencia 500W 110V L 600mm An 95mm longitud brida 124mm anchura brida 22mm dist. del agujero 118mm longitud de empalme 122mm empalme conector Faston 6,3mm tubo ø 8.5mm espirales 1 brida rectangular pos. de montaje abajo agujero ø 6mm resistencia seca		
<b>Para modelos:</b>	MHC 18B, MHC 18PB, MHC 30B, MHC 30PB, MHK - MHC - MHB		



<b>código</b>	418170	<b>referencia</b>	74420410
<b>descripción</b>	resistencia 560W 110V L 800mm An 97mm longitud brida 124mm anchura brida 30mm dist. del agujero 108mm longitud de empalme 123mm empalme conector Faston 6,3mm tubo ø 8.5mm espirales 1 brida rectangular pos. de montaje abajo agujero ø 6.3mm resistencia seca		
<b>Para modelos:</b>	MHC 18C, MHC 18PC, MHC 30C, MHC 30PC, MHK - MHC - MHB		





imagen no disponible

<b>código</b>	418163	<b>referencia</b>	74420340
<b>descripción</b>	resistencia 600W 110V pos. de montaje arriba resistencia seca		
<b>Para modelos:</b>	MHC 18A, MHC 18PA, MHC 30A, MHC 30PA, MHK - MHC - MHB		



<b>código</b>	418171	<b>referencia</b>	74400830
<b>descripción</b>	resistencia 625W 230V L 1235mm An 74mm longitud brida 110mm anchura brida 22mm dist. del agujero 94mm longitud de empalme 106mm empalme conector Faston 6,3mm tubo ø 8.5mm espirales 1 brida rectangular agujero ø 6mm resistencia seca		
<b>Para modelos:</b>	RHC 18B, RHC 18D, RHC 18PB, RHC 18PD, RHC 25B, RHC 25PB, RHC 25PD, RHC-25D, RHK - RHC - RHB		

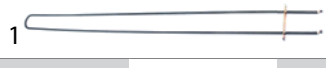

			
<b>código</b>	416377	<b>referencia</b>	74400720
<b>descripción</b>	resistencia 700W 220V L 610mm An 80mm longitud brida 124mm anchura brida 30mm dist. del agujero 108mm longitud de empalme 98mm empalme conector Faston 6,3mm tubo ø 8.5mm espirales 1 brida rectangular agujero ø 4mm		

			
<b>código</b>	418172	<b>referencia</b>	74400760
<b>descripción</b>	resistencia 700W 230V L 1238mm An 74mm longitud brida 110mm anchura brida 22mm dist. del agujero 94mm longitud de empalme 110mm empalme conector Faston 6,3mm tubo ø 8.5mm espirales 1 brida rectangular agujero ø 6mm resistencia seca		
<b>Para modelos:</b>	RHC 18C, RHC 18PC, RHC 25C, RHC 25PC, RHK - RHC - RHB		



			
<b>código</b>	418161	<b>referencia</b>	74420610
<b>descripción</b>	resistencia 728W 115V L 1041mm An 89mm longitud brida 124mm anchura brida 30mm dist. del agujero 108mm longitud de empalme 92mm empalme conector Faston 6,3mm tubo ø 8.5mm espirales 1 brida rectangular pos. de montaje abajo agujero ø 5.2mm resistencia seca		
<b>Para modelos:</b>	PIZZY DUO 105.105, PIZZY MONO 105.105		

 imagen no disponible			
1			
<b>código</b>	418166	<b>referencia</b>	74420360
<b>descripción</b>	resistencia 750W 110V pos. de montaje arriba resistencia seca		
<b>Para modelos:</b>	MHC 18B, MHC 18PB, MHC 30B, MHC 30PB, MHK - MHC - MHB		

 imagen no disponible			
1			
<b>código</b>	418169	<b>referencia</b>	74420400
<b>descripción</b>	resistencia 850W 110V pos. de montaje arriba resistencia seca		
<b>Para modelos:</b>	MHC 18C, MHC 18PC, MHC 30C, MHC 30PC, MHK - MHC - MHB		

			
<b>código</b>	418162	<b>referencia</b>	74420560
<b>descripción</b>	resistencia 910W 115V L 603mm An 97mm longitud brida 124mm anchura brida 22mm dist. del agujero 102mm longitud de empalme 121mm empalme conector Faston 6,3mm tubo ø 8.8mm espirales 1 brida rectangular pos. de montaje arriba agujero ø 5mm resistencia seca		
<b>Para modelos:</b>	MHC 18A, MHC 18B, MHC 18C, MHC 30A, MHC 30B, MHC 30C, MHK - MHC - MHB		

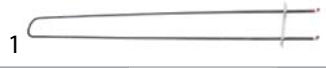
			
<b>código</b>	418183	<b>referencia</b>	74420850
<b>descripción</b>	resistencia 1250W 230V L 1032mm pos. de montaje arriba ø 34mm tubo ø 16mm rosca M20x1.5 longitud de empalme 45mm empalme M6 brida roscada espirales 1 resistencia seca horno de pizza		
<b>Para modelos:</b>	T97E		

			
<b>código</b>	418182	<b>referencia</b>	74420750
<b>descripción</b>	resistencia 1400W 230V L 775mm pos. de montaje abajo ø 34mm tubo ø 16mm rosca M20x1.5 longitud de empalme 63mm empalme M6 espirales 1 resistencia seca horno de pizza		
<b>Para modelos:</b>	T75E		

			
<b>código</b>	418726	<b>referencia</b>	74400260 74400390
<b>descripción</b>	resistencia 1456W 230V espirales 1 resistencia seca		
<b>Para modelos:</b>	KR 9, KR 99, KRX 9, KRX 99, PIZZY DUO 105.105, PIZZY MONO 105.105		

			
<b>código</b>	418181	<b>referencia</b>	74420740
<b>descripción</b>	resistencia 1600W 230V L 770mm pos. de montaje arriba ø 34mm tubo ø 16mm rosca M20x1.5 longitud de empalme 63mm empalme M6 espirales 1 resistencia seca horno de pizza		
<b>Para modelos:</b>	T75E		

			
<b>código</b>	418728	<b>referencia</b>	74400180
<b>descripción</b>	resistencia 1650W 230V L 1070mm An 130mm rosca 1/4" distancia de sujeción 121mm longitud de empalme 100mm espirales 1 resistencia seca		
<b>Para modelos:</b>	KR 6, KR 66, KRX 6, KRX 66, PIZZY DUO 65.105, PIZZY MONO 65.105		

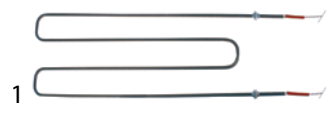
			
<b>código</b>	418729	<b>referencia</b>	74400250
<b>descripción</b>	resistencia 1750W 230V L 680mm An 260mm rosca 1/4" distancia de sujeción 251mm longitud de empalme 101mm tubo ø 8.5mm espirales 1 resistencia seca		
<b>Para modelos:</b>	KR 66T, KR 6T, KRX 66T, KRX 6T, PIZZY DUO 105.65, PIZZY MONO 105.65		

			
<b>código</b>	418184	<b>referencia</b>	74420860
<b>descripción</b>	resistencia 1900W 230V L 1030mm pos. de montaje abajo ø 34mm tubo ø 16mm rosca M20x1.5 longitud de empalme 45mm empalme M6 brida roscada espirales 1 resistencia seca horno de pizza		
<b>Para modelos:</b>	T97E		

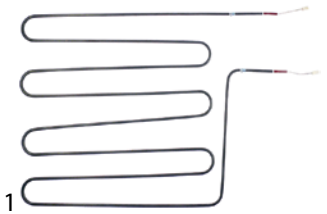

<b>código</b>	417588	<b>referencia</b>	74401180
<b>descripción</b>	resistencia 2100W 230V L 675mm An 526mm L1 40mm L2 637mm B1 420mm B2 140mm rosca 1/4" tubo ø 8.5mm longitud del cable 170mm espirales 1 horno de pizza atornillado		

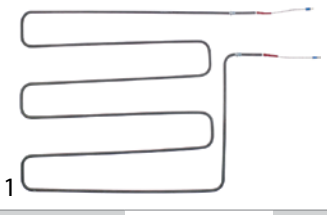

<b>código</b>	418157	<b>referencia</b>	74400150 74420690
<b>descripción</b>	resistencia 2100W 230V L 675mm An 550mm L1 35mm L2 640mm B1 415mm B2 135mm rosca 1/4" distancia de sujeción 127mm longitud de empalme 90mm empalme conector Faston 6,3mm tubo ø 8.5mm longitud del cable 140mm espirales 1 resistencia seca sujeción 2 orificios horno de pizza		
<b>Para modelos:</b>	KR 4, KR 44, KRX 4, KRX 44, PD60.60, PIZZY DUO 60.60, PIZZY DUO 65.105, PIZZY MONO 60.60, PIZZY MONO 65.105		



<b>código</b>	418730	<b>referencia</b>	74400280
<b>descripción</b>	resistencia 2400W 230V L 1200mm An 290mm espirales 1 resistencia seca horno de pizza		
<b>Para modelos:</b>	KR 9, KR 99, KRX 9, KRX 99, PIZZY DUO 105.105, PIZZY MONO 105.105		

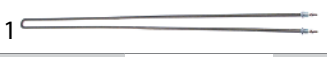

<b>código</b>	418187	<b>referencia</b>	74400790
<b>descripción</b>	resistencia 750W 230V resistencia seca sujeción 2 orificios		
<b>Para modelos:</b>	AHL, L105.105, L65.105, MHL, P110L, RHL		

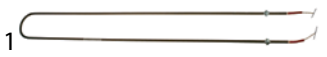

<b>código</b>	418727	<b>referencia</b>	74400160
<b>descripción</b>	resistencia 920W 230V L 1040mm An 120mm rosca 1/4" distancia de sujeción 111mm longitud de empalme 100mm tubo ø 9mm espirales 1 resistencia seca		
<b>Para modelos:</b>	KR 6, KR 66, KRX 6, KRX 66, PIZZY DUO 65.105, PIZZY MONO 65.105		



<b>código</b>	418725	<b>referencia</b>	74400210
<b>descripción</b>	resistencia 972W 230V L 645mm An 195mm rosca 1/4" distancia de sujeción 186mm longitud de empalme 102mm tubo ø 8.5mm espirales 1 resistencia seca		
<b>Para modelos:</b>	KR 66T, KR 6T, KRX 66T, KRX 6T, PIZZY DUO 105.65, PIZZY MONO 105.65		



<b>código</b>	419237	<b>referencia</b>	54600290
<b>descripción</b>	cable de calefacción pos. de montaje abajo UE 1 pzs horno de pizza apto para AHC_A/AHK		
<b>Para modelos:</b>	AHC 18A, AHK		



<b>código</b>	419239	<b>referencia</b>	54600270
<b>descripción</b>	cable de calefacción pos. de montaje abajo UE 1 pzs horno de pizza apto para AHC_B/AHB		
<b>Para modelos:</b>	AHB, AHC 18B		



<b>código</b>	419241	<b>referencia</b>	54600310
<b>descripción</b>	cable de calefacción pos. de montaje abajo UE 1 pzs horno de pizza apto para AHC_C		
<b>Para modelos:</b>	AHC, AHC 18C		

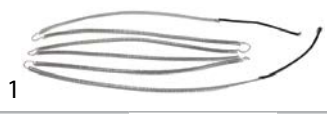

<b>código</b>	419236	<b>referencia</b>	54600300
<b>descripción</b>	cable de calefacción pos. de montaje arriba UE 1 pzs horno de pizza apto para AHC_A/AHK		
<b>Para modelos:</b>	AHC 18A, AHK		

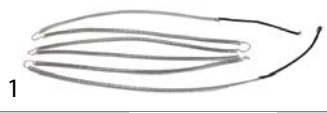

<b>código</b>	419238	<b>referencia</b>	54600280
<b>descripción</b>	cable de calefacción pos. de montaje arriba UE 1 pzs horno de pizza apto para AHC_B/AHB		
<b>Para modelos:</b>	AHB, AHC 18B		





<b>código</b>	419240	<b>referencia</b>	54600320
<b>descripción</b>	cable de calefacción pos. de montaje arriba UE 1 pzs horno de pizza apto para AHC_C		
<b>Para modelos:</b>	AHC, AHC 18C		





			
<b>código</b>	418176	<b>referencia</b>	66009700
<b>descripción</b>	juego de cables de calentamiento pos. de montaje abajo UE 3 pzs horno de pizza apto para AHC_A/AHK		

			
<b>código</b>	418178	<b>referencia</b>	66009720
<b>descripción</b>	juego de cables de calentamiento pos. de montaje abajo UE 3 pzs horno de pizza apto para AHC_B/AHB		

			
<b>código</b>	418180	<b>referencia</b>	66009740
<b>descripción</b>	juego de cables de calentamiento pos. de montaje abajo UE 3 pzs horno de pizza apto para AHC_C		

			
<b>código</b>	418175	<b>referencia</b>	66009690
<b>descripción</b>	juego de cables de calentamiento pos. de montaje arriba UE 3 pzs horno de pizza apto para AHC_A/AHK		

			
<b>código</b>	418177	<b>referencia</b>	66009710
<b>descripción</b>	juego de cables de calentamiento pos. de montaje arriba UE 3 pzs horno de pizza apto para AHC_B/AHB		

			
<b>código</b>	418179	<b>referencia</b>	66009730
<b>descripción</b>	juego de cables de calentamiento pos. de montaje arriba UE 3 pzs horno de pizza apto para AHC_C		

## resistencias para formadoras de pizzas

			
<b>código</b>	418185	<b>referencia</b>	74420770
<b>descripción</b>	resistencia 1500W 230V L 375mm An 268mm empalme conector Faston 6,3mm resistencia seca tubo ø 8.5mm espirales 4		

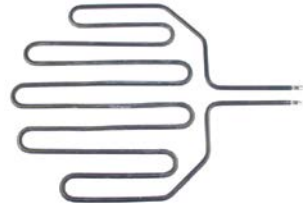
			
<b>código</b>	418186	<b>referencia</b>	74420780
<b>descripción</b>	resistencia 2500W 230V L 478mm An 347mm empalme conector Faston 6,3mm longitud de empalme 23mm L1 140mm L2 337mm B1 155mm B2 32mm resistencia seca tubo ø 8.9mm espirales 5		
<b>Para modelos:</b>	PRESSY 33, PRESSY 45		

## resistencias de tubo de aletas

			
<b>código</b>	418183	<b>referencia</b>	74420850
<b>descripción</b>	resistencia 1250W 230V L 1032mm pos. de montaje arriba ø 34mm tubo ø 16mm rosca M20x1.5 longitud de empalme 45mm empalme M6 brida roscada espirales 1 resistencia seca horno de pizza		
<b>Para modelos:</b>	T97E		

			
<b>código</b>	418182	<b>referencia</b>	74420750
<b>descripción</b>	resistencia 1400W 230V L 775mm pos. de montaje abajo ø 34mm tubo ø 16mm rosca M20x1.5 longitud de empalme 63mm empalme M6 espirales 1 resistencia seca horno de pizza		
<b>Para modelos:</b>	T75E		

			
<b>código</b>	418181	<b>referencia</b>	74420740
<b>descripción</b>	resistencia 1600W 230V L 770mm pos. de montaje arriba ø 34mm tubo ø 16mm rosca M20x1.5 longitud de empalme 63mm empalme M6 espirales 1 resistencia seca horno de pizza		
<b>Para modelos:</b>	T75E		

			
<b>código</b>	418184	<b>referencia</b>	74420860
<b>descripción</b>	resistencia 1900W 230V L 1030mm pos. de montaje abajo ø 34mm tubo ø 16mm rosca M20x1.5 longitud de empalme 45mm empalme M6 brida roscada espirales 1 resistencia seca horno de pizza		
<b>Para modelos:</b>	T97E		

			
<b>código</b>	419115	<b>referencia</b>	74400300
<b>descripción</b>	resistencia 2400W 230V L 1020mm ø 33.5mm tubo ø 16mm rosca M20x1.5 longitud de empalme 66mm empalme M6 sujeción 2 orificios espirales 1 resistencia seca horno		
<b>Para modelos:</b>	T97E		

## termostatos

### termostatos de control y seguridad

EGO

termostatos de regulación

serie 55.10/19\_



<b>código</b>	375273	<b>referencia</b>	74220840
<b>descripción</b>	termóstato T máx 200°C margen de trabajo 60-200°C 1 polos 1NO 16A sonda ø 6mm sonda L 74mm capilar 1500mm aislamiento del capilarmm prensaestopas eje L 23mm posición del eje arriba ángulo de rotación 270°		
<b>Para modelos:</b>	PRESSY 33, PRESSY 45		



<b>código</b>	375253	<b>referencia</b>	74300110
<b>descripción</b>	termóstato T máx 455°C margen de trabajo 85-455°C 1 polos 1NO 16A sonda ø 3.9mm sonda L 228mm capilar 870mm aislamiento del capilar 660mm prensaestopas eje ø 6x4,6mm eje L 23mm posición del eje arriba ángulo de rotación 270°		
<b>Para modelos:</b>	KR 4, KR 44, KR 6, KR 66, KR 66T, KR 6T, KR 9, KR 99, KRX 4, KRX 44, KRX 6, KRX 66, KRX 66T, KRX 6T, KRX 9, KRX 99, PIZZY DUO 105.105, PIZZY DUO 105.65, PIZZY DUO 60.60, PIZZY DUO 65.105, PIZZY MONO 105.105, PIZZY MONO 105.65, PIZZY MONO 60.60, PIZZY MONO 65.105		



<b>código</b>	375661	<b>referencia</b>	74310830
<b>descripción</b>	termóstato T máx 500°C margen de trabajo 75-500°C 1 polos 1NO 16A sonda ø 3.9mm sonda L 228mm capilar 1470mm aislamiento del capilar 960mm prensaestopas eje ø 6x4,6mm eje L 23mm posición del eje arriba ángulo de rotación 270°		
<b>Para modelos:</b>	PIZZY DUO 105.105, PIZZY DUO 105.65, PIZZY DUO 60.60, PIZZY DUO 65.105, PIZZY MONO 105.105, PIZZY MONO 105.65, PIZZY MONO 60.60, PIZZY MONO 65.105		

serie 55.34\_



<b>código</b>	375498	<b>referencia</b>	74200140
<b>descripción</b>	termóstato T máx 512°C margen de trabajo 60-512°C 3 polos 3NO 16A sonda ø 3.8mm sonda L 225mm capilar 1150mm aislamiento del capilar 1110mm prensaestopas eje ø 6x4,6mm eje L 32mm posición del eje arriba ángulo de rotación 270°		

termostatos de seguridad

serie 55.10/19\_



<b>código</b>	375663	<b>referencia</b>	74220860
<b>descripción</b>	termóstato de seguridad capilar 1500mm sonda ø 4mm 1 polos sonda L 228mm 16A aislamiento del capilar 900mm prensaestopas temp. desconexión 410°C bulbo inox		
<b>Para modelos:</b>	T75E, T97E		

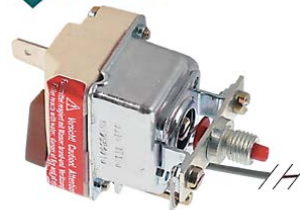

<b>código</b>	375662	<b>referencia</b>	74200370
<b>descripción</b>	termóstato de seguridad temp. desconexión 512°C 1 polos 16A sonda ø 3.9mm sonda L 228mm capilar 1470mm aislamiento del capilar 960mm prensaestopas bulbo inox unión roscada M8x1		
<b>Para modelos:</b>	AHB, AHC, AHK, MHK - MHC - MHB, P110 GAS, P110 GAS A, P110 GAS B, RHK - RHC - RHB		
<b>accesorios para</b>	375662		
		<b>código</b>	102067
		<b>referencia</b>	—
			tuerca rosca M8x1 H 3mm latón UE 1 pzs tipo SEF 1





JUMO

termostatos de seguridad



<b>código</b>	390169	<b>referencia</b>	74200260
<b>descripción</b>	termostato de seguridad temp. desconexión 20-500°C margen de trabajo°C 1 polos 1NC 16A sonda ø 6mm sonda L 275mm capilar 1000mm aislamiento del capilarmm prensaestopas eje ømm material de bulbo cobre 230V		
<b>Para modelos:</b>	AHC 18A, AHC 18B, AHC 18C, MHC 18A, MHC 18B, MHC 18C, MHC 18PA, MHC 18PB, MHC 18PC, MHC 30A, MHC 30B, MHC 30C, MHC 30PA, MHC 30PB, MHC 30PC, PG/GAS, RHC 18B, RHC 18C, RHC 18D, RHC 18PB, RHC 18PC, RHC 18PD, RHC 25B, RHC 25C, RHC 25PB, RHC 25PC, RHC 25PD, RHC-25D		

<b>código</b>	346377	<b>referencia</b>	74550520
<b>descripción</b>	interruptor basculante medida de montaje 30x22mm negro 2CO 230V 16A 0-I empalme conector Faston 6,3mm temperatura ambiente máx. 125/55°C protección IP40		
<b>Para modelos:</b>	PIZZY DUO 60.60, PIZZY MONO 60.60		
<b>accesorios para</b>	346377		
	<b>código</b>	301036	<b>referencia</b> —
	cubierta protectora dimensión interior 30x22mm para interruptor basculante medida de montaje mm		

<b>código</b>	301255	<b>referencia</b>	74500010
<b>descripción</b>	interruptor basculante medida de montaje 30x22mm azul 2NO 250V 16A iluminado 0-I empalme conector Faston 6,3mm temperatura ambiente máx. 85°C protección IP40		
<b>Para modelos:</b>	KRX 6, KRX 66, KRX 66T, KRX 6T, KRX 9, KRX 99		
<b>accesorios para</b>	301255		
	<b>código</b>	301036	<b>referencia</b> —
	cubierta protectora dimensión interior 30x22mm para interruptor basculante medida de montaje mm		

<b>código</b>	347505	<b>referencia</b>	74500040
<b>descripción</b>	interruptor basculante medida de montaje 30x22mm azul 2NO 250V 16A iluminado 0-iluminación empalme conector Faston 6,3mm temperatura ambiente máx. 85°C protección IP40		
<b>Para modelos:</b>	KRX 4, KRX 44, KRX 6, KRX 66, KRX 66T, KRX 6T, KRX 9, KRX 99		

<b>código</b>	346378	<b>referencia</b>	74500220 74500400 74500720
<b>descripción</b>	interruptor basculante medida de montaje 30x22mm verde 2NO 250V 16A iluminado iluminación empalme conector Faston 6,3mm temperatura ambiente máx. 100/55°C protección IP40		
<b>Para modelos:</b>	AHL, BAKY 5TM, KR 4, KR 44, KR 6, KR 66, KR 66T, KR 6T, KR 9, KR 99, L105.105, L105.65, L60.60, L65.105, MHL, P110L, PIZZY DUO 105.105, PIZZY DUO 105.65, PIZZY DUO 60.60, PIZZY DUO 65.105, PIZZY MONO 105.105, PIZZY MONO 105.65, PIZZY MONO 60.60, PIZZY MONO 65.105, RHL		

interruptores y pulsadores  
interruptores/pulsadores basculantes

30x22mm



<b>código</b>	301003	<b>referencia</b>	74500120
<b>descripción</b>	interruptor basculante medida de montaje 30x22mm verde 2NO 250V 16A iluminado 0-I empalme conector Faston 6,3mm temperatura ambiente máx. 125/55°C protección IP65		
<b>Para modelos:</b>	AHB, AHC, AHC 18A, AHC 18B, AHC 18C, AHK, BAKY 5TE, BAKY 5TM, F80E, KR 6, KR 66, KR 66T, KR 6T, KR 9, KR 99, L105.105, L105.65, L60.60, L65.105, MHC 18A, MHC 18B, MHC 18C, MHC 18PA, MHC 18PB, MHC 18PC, MHC 30A, MHC 30B, MHC 30C, MHC 30PA, MHC 30PB, MHC 30PC, MHK - MHC - MHB, MHL, P110 GAS, P110 GAS A, P110 GAS B, PC/GAS, PIZZY DUO 105.105, PIZZY DUO 105.65, PIZZY DUO 65.105, PIZZY MONO 105.105, PIZZY MONO 105.65, PIZZY MONO 65.105, R08G GAS, RHC 18B, RHC 18C, RHC 18D, RHC 18PB, RHC 18PC, RHC 18PD...(Otros modelos se puede ver en la tienda web)		
<b>accesorios para</b>	301003		
	<b>código</b>	301036	<b>referencia</b> —
	cubierta protectora dimensión interior 30x22mm para interruptor basculante medida de montaje mm		



<b>código</b>	301017	<b>referencia</b>	74500130
<b>descripción</b>	interruptor basculante medida de montaje 30x22mm verde 2CO 250V 16A iluminado empalme conector Faston 6,3mm temperatura ambiente máx. 125/55°C protección IP40		
<b>Para modelos:</b>	KR 4, KR 44, PIZZY DUO 60.60, PIZZY MONO 60.60		
<b>accesorios para</b>	301017		
	<b>código</b>	301036	<b>referencia</b> —
	cubierta protectora dimensión interior 30x22mm para interruptor basculante medida de montaje mm		

## microinterruptores

### accionado por palanca



1			
<b>código</b>	345125	<b>referencia</b>	74550740
<b>descripción</b>	microinterruptor con manilla 250V 16A 1CO empalme conector Faston 6,3mm temperatura ambiente máx. 85°C distancia de sujeción 25mm tipo C99ZP3 fuerza de accionamiento: 25g longitud de palanca 63.5mm		
<b>Para modelos:</b>	PRESSY 33, PRESSY 45		

### accionados por rodillo

#### rollo 0°



1			
<b>código</b>	345639	<b>referencia</b>	74550730
<b>descripción</b>	microinterruptor con rueda de presión 230V 16A 1CO empalme conexión de soldadura/con tornillos L1 49mm temperatura ambiente máx. 125°C rosca L 14mm rosca M10 distancia de sujeción 25mm fuerza de accionamiento: 300g tipo MS15-1		
<b>Para modelos:</b>	PRESSY 33, PRESSY 45		

## conmutadores giratorios

### BRETER

#### conmutadores giratorios



1			
<b>código</b>	346381	<b>referencia</b>	74500440
<b>descripción</b>	conmutador giratorio		
<b>Para modelos:</b>	PRESSY 33, PRESSY 45, T75E, T97E		



1			
<b>código</b>	346379 <sup>1</sup>	<b>referencia</b>	74500480
<b>descripción</b>	conmutador giratorio 2 0-1 juegos de contactos 3 tipo 3LD2203-0TK53 600V 32A eje ø 5x5mm eje L 20mm eje cuadrado con pomo empalme atornillado		
<b>Para modelos:</b>	T75E		

<sup>1</sup>con pomo y símbolo



1			
<b>código</b>	346380	<b>referencia</b>	74500490
<b>descripción</b>	conmutador giratorio 2 0-1 juegos de contactos 3 tipo 3LD2504-0TK53 600V 63A eje ø 8x9mm eje L 20mm eje en forma de estrella con interruptor empalme atornillado		
<b>Para modelos:</b>	T75E, T97E		

### otros



1			
<b>código</b>	346383	<b>referencia</b>	74500530
<b>descripción</b>	conmutador giratorio juegos de contactos 4 2 0-1 tipo 3LD2003-0TK53 690V 16A eje ø 6x6mm eje L 24.5mm eje cuadrado L1-L2-L3-N empalme borne roscado		
<b>Para modelos:</b>	PRESSY 33, PRESSY 45, T75G, T97G		

## aparatos de mando y aviso

### ALLEN BRADLEY

#### teclas



1			
<b>código</b>	346382	<b>referencia</b>	74550140
<b>descripción</b>	tecla medida de montaje ø22mm iluminado verde		



1			
<b>código</b>	346396	<b>referencia</b>	74550270
<b>descripción</b>	bloque de contacto 800E-3X10 1NO/1NC máx. 400V 8A		



SIEMENS

serie 3SB ø22mm nuevo

teclas



<b>código</b>	346618	<b>referencia</b>	74550140
---------------	--------	-------------------	----------

**descripción** tecla medida de montaje ø22mm sin iluminación verde

**Para modelos:** ITP/40, PRESSY 33, PRESSY 45, RFP/15

**accesorios para** 346618



<b>código</b>	346632	<b>referencia</b>	—
---------------	--------	-------------------	---

bloque de contacto SIEMENS 3SB3400-0D 1NC/1NO máx. 400V 10A negro

lámpade

bombillas incandescentes

para hornos



<b>código</b>	359612	<b>referencia</b>	74420260
---------------	--------	-------------------	----------

**descripción** bombilla incandescente T máx 300°C casquillo E14 25W 230V ø 25mm L 56mm cristal L 30mm para lámpara de horno tipo Philips

**Para modelos:** AHB, AHC, AHC 18A, AHC 18B, AHC 18C, AHK, AHL, BAKY 5TE, BAKY 5TM, F80E, F80L, KR 4, KR 44, KR 6, KR 66, KR 66T, KR 6T, KR 9, KR 99, KRX 4, KRX 44, KRX 6, KRX 66, KRX 66T, KRX 6T, KRX 9, KRX 99, L105.105, L105.65, L60.60, L65.105, MHC 18A, MHC 18B, MHC 18C, MHC 18PA, MHC 18PB, MHC 18PC, MHC 30A, MHC 30B, MHC 30C, MHC 30PA, MHC 30PB, MHC 30PC, MHK - MHC - MHB, MHL, P110 GAS, P110 GAS A, P110 GAS B, P110L, PC/GAS...(Otros modelos se puede ver en la tienda web)

lámparas

lámparas de señalización

lámparas de señalización completas

ø10mm

con casquillo enchufable



<b>código</b>	359263	<b>referencia</b>	74420790
---------------	--------	-------------------	----------

**descripción** lámpara de señalización ø 10mm

**Para modelos:** PRESSY 33, PRESSY 45

ø13mm

con casquillo enchufable



<b>código</b>	359143	<b>referencia</b>	74420520
---------------	--------	-------------------	----------

**descripción** lámpara de señalización ø 13mm amarillo 230V empalme conector Faston 6,3mm resis.a la temp. 120°C UE 1 pzs

**Para modelos:** AHL, BAKY 5TM, F80L, KR 4, KR 44, KR 6, KR 66, KR 66T, KR 6T, KR 9, KR 99, KRX 4, KRX 44, KRX 6, KRX 66, KRX 66T, KRX 6T, KRX 9, KRX 99, L105.105, L105.65, L60.60, L65.105, MHL, P110L, PIZZY DUO 105.105, PIZZY DUO 105.65, PIZZY DUO 60.60, PIZZY DUO 65.105, PIZZY MONO 105.105, PIZZY MONO 105.65, PIZZY MONO 60.60, PIZZY MONO 65.105, RHL, TVHL

lámparas halógenas

para portalámpara G4 / G6,35 / G9



<b>código</b>	359946	<b>referencia</b>	74401460
---------------	--------	-------------------	----------

**descripción** lámpara halógena casquillo G9 230V 40W resis.a la temp. 300°C

lámparas para hornos

lámparas de horno universales

diámetro de montaje 47,8mm



<b>código</b>	359499	<b>referencia</b>	74700070
---------------	--------	-------------------	----------

**descripción** portalámparas casquillo E14 montaje ø 47.8mm empalme conector Faston 6,3mm

**Para modelos:** AHB, AHC, AHC 18A, AHC 18B, AHC 18C, AHK, AHL, F80L, KR 4, KR 44, KR 6, KR 66, KR 66T, KR 6T, KR 9, KR 99, KRX 4, KRX 44, KRX 6, KRX 66, KRX 66T, KRX 6T, KRX 9, KRX 99, L105.105, L105.65, L60.60, L65.105, MHC 18A, MHC 18B, MHC 18C, MHC 18PA, MHC 18PB, MHC 18PC, MHC 30A, MHC 30B, MHC 30C, MHC 30PA, MHC 30PB, MHC 30PC, MHK - MHC - MHB, MHL, P110 GAS, P110 GAS A, P110 GAS B, P110L, PC/GAS, PIZZY DUO 105.105, PIZZY DUO 105.65, PIZZY DUO 60.60...(Otros modelos se puede ver en la tienda web)

**accesorios para** 359499





<b>código</b>	359725	<b>referencia</b>	—
---------------	--------	-------------------	---

cubierta para lámpara de horno rosca ø 44mm H 43mm ø 54mm vidrio duro resis.a la temp. 350°C







			
1			
<b>código</b>	360541	<b>referencia</b>	74700200
<b>descripción</b>	portalámparas casquillo G9 250V montaje ø 47.8mm empalme conector Faston 6,3mm		
<b>accesorios para</b>	360541		
	<b>código</b>	359725	<b>referencia</b>
			—
<b>descripción</b>	cubierta para lámpara de horno rosca ø 44mm H 43mm ø 54mm vidrio duro resis.a la temp. 350°C		
	<b>código</b>	359946	<b>referencia</b>
			74401460
<b>descripción</b>	lámpara halógena casquillo G9 230V 40W resis.a la temp. 300°C		

diámetro de montaje 65,5mm			
			
1			
<b>código</b>	359724	<b>referencia</b>	73700690
<b>descripción</b>	cubierta para lámpara de horno rosca ø 62mm H 46mm ø 74mm vidrio duro resis.a la temp. 350°C		
<b>Para modelos:</b>	AHC, AHC 18A, AHC 18B, AHC 18C, AHC 18C, AHK, KR 4, KR 44, KR 6, KR 66, KR 66T, KR 6T, KR 9, KR 99, KRX 4, KRX 44, KRX 6, KRX 66, KRX 66T, KRX 6T, KRX 9, KRX 99, MHC 18A, MHC 18B, MHC 18C, MHC 18PA, MHC 18PB, MHC 18PC, MHC 30A, MHC 30B, MHC 30C, MHC 30PA, MHC 30PB, MHC 30PC, MHK - MHC - MHB, P110 GAS, P110 GAS A, P110 GAS B, PC/GAS, PIZZY DUO 105.105, PIZZY DUO 105.65, PIZZY DUO 60.60, PIZZY DUO 65.105, PIZZY MONO 105.105, PIZZY MONO 105.65, PIZZY MONO 60.60, PIZZY MONO 65.105, RHC 18B, RHC 18C, RHC 18D...(Otros modelos se puede ver en la tienda web)		

50x75,5mm			
			
1			
<b>código</b>	359303	<b>referencia</b>	73700790
<b>descripción</b>	cubierta para lámpara de horno L 88mm An 54mmVW casquillo empalme para lámpara de horno		

lámparas			
bombillas incandescentes			
			
1			
<b>código</b>	359612	<b>referencia</b>	74420260
<b>descripción</b>	bombilla incandescente T máx 300°C casquillo E14 25W 230V ø 25mm L 56mm cristal L 30mm para lámpara de horno tipo Philips		
<b>Para modelos:</b>	AHC, AHC 18A, AHC 18B, AHC 18C, AHC 18C, AHK, AHL, BAKY 5TE, BAKY 5TM, F80E, F80L, KR 4, KR 44, KR 6, KR 66, KR 66T, KR 6T, KR 9, KR 99, KRX 4, KRX 44, KRX 6, KRX 66, KRX 66T, KRX 6T, KRX 9, KRX 99, L105.105, L105.65, L60.60, L65.105, MHC 18A, MHC 18B, MHC 18C, MHC 18PA, MHC 18PB, MHC 18PC, MHC 30A, MHC 30B, MHC 30C, MHC 30PA, MHC 30PB, MHC 30PC, MHK - MHC - MHB, MHL, P110 GAS, P110 GAS A, P110 GAS B, P110L, PC/GAS...(Otros modelos se puede ver en la tienda web)		

lámparas halógenas			
para portalámpara G4 / G6,35 / G9			
			
1			
<b>código</b>	359946	<b>referencia</b>	74401460
<b>descripción</b>	lámpara halógena casquillo G9 230V 40W resis.a la temp. 300°C		

contactores

SIEMENS

contactores de potencia

			
1			
<b>código</b>	380389	<b>referencia</b>	74550230
<b>descripción</b>	contactor de potencia AC1 22A 230VAC (AC3/400V) 9A/4kW contactos principales 3NO contactos auxiliares 1NO empalme empalme atornillado tipo 3RT10-16-1AP01		
<b>Para modelos:</b>	AHC, AHC 18A, AHC 18B, AHC 18C, AHC 18C, AHK, BAKY 5TE, BAKY 5TM, F40E, F80E, KR 6, KR 66, KR 66T, KR 6T, KR 9, KR 99, KRX 6, KRX 66, KRX 66T, KRX 6T, KRX 9, KRX 99, MHC 18A, MHC 18B, MHC 18C, MHC 18PA, MHC 18PB, MHC 18PC, MHC 30A, MHC 30B, MHC 30C, MHC 30PA, MHC 30PB, MHC 30PC, MHK - MHC - MHB, PIZZY DUO 105.105, PIZZY DUO 105.65, PIZZY MONO 105.105, PIZZY MONO 105.65, PIZZY MONO 65.105, RHC 18B, RHC 18C, RHC 18D, RHC 18PB, RHC 18PC, RHC 18PD, RHC 25B, RHC 25C, RHC 25PB...(Otros modelos se puede ver en la tienda web)		



			
1			
<b>código</b>	380390	<b>referencia</b>	74550500
<b>descripción</b>	contactor de potencia AC1 40A 230VAC (AC3/400V) 12A/5,5kW contactos principales 3NO contactos auxiliares empalme empalme atornillado tipo 3RT10-24-1AL20 50/60Hz		
<b>Para modelos:</b>	AHB, AHC, AHC 18A, AHC 18B, AHC 18C, AHK, KR 9, KR 99, KRX 9, KRX 99, MHC 18A, MHC 18B, MHC 18C, MHC 18PA, MHC 18PB, MHC 18PC, MHC 30A, MHC 30B, MHC 30C, MHC 30PA, MHC 30PB, MHC 30PC, MHK - MHC - MHB, PIZZY DUO 105.105, PIZZY MONO 105.105, RHC 18B, RHC 18C, RHC 18D, RHC 18PB, RHC 18PC, RHC 18PD, RHC 25B, RHC 25C, RHC 25PB, RHC 25PC, RHC 25PD, RHC-25D, RHK - RHC - RHB, T75E, TIVOLI EL HI-TECH, TREVI ELETTRICO		

## transformadores

### transformadores abiertos

#### con borne de empalme

			
1			
<b>código</b>	401289	<b>referencia</b>	74110290
<b>descripción</b>	transformador primaria 230/400V secundaria 12V 100VA		
<b>Para modelos:</b>	F40E, F80E, R14G GAS, T75E, T75G, T97E, T97G		

### transformadores encapsulados

#### conexiones múltiples

			
1			
<b>código</b>	401285	<b>referencia</b>	74110200
<b>descripción</b>	transformador primaria 230VAC secundaria 12VAC 10VA		
<b>Para modelos:</b>	AHB, AHC, AHC 18A, AHC 18B, AHC 18C, AHK, MHC 18A, MHC 18B, MHC 18C, MHC 18PA, MHC 18PB, MHC 18PC, MHC 30A, MHC 30B, MHC 30C, MHC 30PA, MHC 30PB, MHC 30PC, MHK - MHC - MHB, P110 GAS, P110 GAS A, P110 GAS B, R08G GAS, R14G GAS, RHC 18B, RHC 18C, RHC 18D, RHC 18PB, RHC 18PC, RHC 18PD, RHC 25B, RHC 25C, RHC 25PB, RHC 25PC, RHC 25PD, RHC-25D, RHK - RHC - RHB		

## sensores

### sensores específicos del fabricante

#### sensores

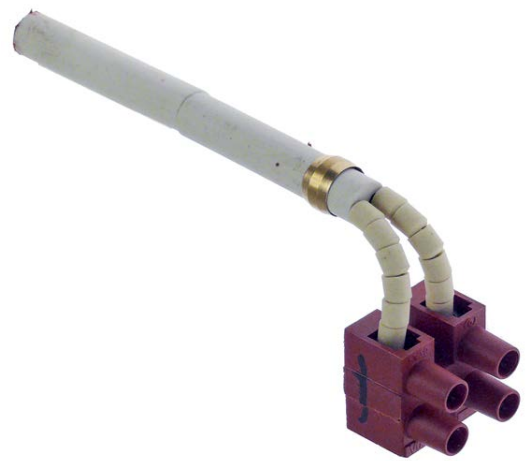
			
1			
<b>código</b>	379975	<b>referencia</b>	66081910
<b>descripción</b>	sensor de temperatura cable cerámica sonda -50 a +750°C cable -100 a +1300°C empalme borne d empalme rosca bulbo ø10x100mm longitud de cable m		
<b>Para modelos:</b>	BAKY 5TE, F40E, F80E, R08G GAS, R14G GAS, T75E, T75G, T97E, T97G, TEVERE HI-TECH, TIVOLI EL HI-TECH, TIVOLI GAS HI-TECH, TREVI ELETTRICO, TREVI GAS		

			
1			
<b>código</b>	379972	<b>referencia</b>	66081040
<b>descripción</b>	sensor de temperatura cable cerámica sonda -50 a +750°C cable -100 a +1300°C empalme borne d empalme rosca bulbo ø10x255mm longitud de cable m		
<b>Para modelos:</b>	P110 GAS, P110 GAS A, P110 GAS B, PC/GAS		



1

<b>código</b>	379973	<b>referencia</b>	66080820
<b>descripción</b>	sensor de temperatura termopar cable cerámica sonda -50 a +750°C cable -100 a +1300°C empalme borne d empalme rosca bulbo ø10x-100mm longitud de cable m		
<b>Para modelos:</b>	MHC 18A, MHC 18B, MHC 18C, MHC 18PA, MHC 18PB, MHC 18PC, MHC 30A, MHC 30B, MHC 30C, MHC 30PA, MHC 30PB, MHC 30PC, MHK - MHC - MHB, RHC 18B, RHC 18C, RHC 18D, RHC 18PB, RHC 18PC, RHC 18PD, RHC 25B, RHC 25C, RHC 25PB, RHC 25PC, RHC 25PD, RHC-25D, RHK - RHC - RHB		



1

<b>código</b>	379974	<b>referencia</b>	66080980
<b>descripción</b>	sensor de temperatura termopar cable cerámica sonda -50 a +750°C cable -100 a +1300°C empalme borne d empalme rosca bulbo ø10x-150mm longitud de cable m		
<b>Para modelos:</b>	AHC 18A, AHC 18B, AHC 18C		



1

<b>código</b>	378330	<b>referencia</b>	66000830
<b>descripción</b>	sensor de temperatura termopar cable cerámica sonda -50 a +750°C cable -100 a +1300°C empalme borne d empalme rosca bulbo ø10x-190mm longitud de cable m		
<b>Para modelos:</b>	AHB, AHC, AHK		

## electrónicas

### placas electrónicas

1

<b>código</b>	401288	<b>referencia</b>	74311220
<b>descripción</b>	placa base		
<b>Para modelos:</b>	T75E, T97E		

1

<b>código</b>	400731	<b>referencia</b>	74670820
<b>descripción</b>	placa base formadora de pizzas Pressy 33/45		
<b>Para modelos:</b>	PRESSY 33, PRESSY 45		

1

<b>código</b>	401271	<b>referencia</b>	768000B0
<b>descripción</b>	placa de teclado		
<b>Para modelos:</b>	AHB, AHC, AHC 18A, AHC 18B, AHC 18C, AHK, MHC 18A, MHC 18B, MHC 18C, MHC 30A, MHC 30B, MHC 30C, MHK - MHC - MHB		

1

<b>código</b>	401272	<b>referencia</b>	768001C0
<b>descripción</b>	placa de teclado		
<b>Para modelos:</b>	MHC 18PA, MHC 18PB, MHC 18PC, MHC 30PA, MHC 30PB, MHC 30PC, MHK - MHC - MHB, RHC 18PB, RHC 18PC, RHC 18PD, RHC 25PB, RHC 25PC, RHC 25PD, RHK - RHC - RHB		



1

<b>código</b>	401287	<b>referencia</b>	74311240
<b>descripción</b>	placa de teclado		
<b>Para modelos:</b>	T75E		



1

<b>código</b>	401291	<b>referencia</b>	74311400
<b>descripción</b>	placa de teclado		
<b>Para modelos:</b>	T97E		



1

<b>código</b>	401853	<b>referencia</b>	768000C0 768000G0 768000R0
<b>descripción</b>	placa de teclado		
<b>Para modelos:</b>	AHB, AHC, AHC 18A, AHC 18B, AHC 18C, AHK, MHC 18A, MHC 18B, MHC 18C, MHC 30A, MHC 30B, MHC 30C, MHK - MHC - MHB, RHC 18B, RHC 18C, RHC 18D, RHC 25B, RHC 25C, RHC-25D, RHK - RHC - RHB		



1

<b>código</b>	401283	<b>referencia</b>	768002R0
<b>descripción</b>	placa de teclado horno para pizzas a gas		



1

<b>código</b>	403059	<b>referencia</b>	768002R0
<b>descripción</b>	placa de teclado horno para pizzas a gas P110 L 140mm An 140mm		
<b>Para modelos:</b>	P110 GAS, P110 GAS A, P110 GAS B, PC/GAS		
<b>repuestos para</b>	403059		
	<b>código</b>	403141	<b>referencia</b> 767002R0
imagen no disponible	membrana de teclado L 140mm An 140mm		



1

<b>código</b>	401435	<b>referencia</b>	768000R0
<b>descripción</b>	placa de teclado horno para pizzas eléctrico L 140mm An 140mm tazas 4		



1

<b>código</b>	403060	<b>referencia</b>	768000R0
<b>descripción</b>	placa de teclado horno para pizzas eléctrico MHC L 140mm An 140mm tazas 6		
<b>Para modelos:</b>	AHB, AHC, AHC 18A, AHC 18B, AHC 18C, AHK, MHC 18A, MHC 18B, MHC 18C, MHC 30A, MHC 30B, MHC 30C, MHK - MHC - MHB		



1

<b>código</b>	401854	<b>referencia</b>	768001R0
<b>descripción</b>	placa de teclado L 144mm An 144mm		
<b>Para modelos:</b>	MHK - MHC - MHB		



1

<b>código</b>	401290	<b>referencia</b>	74220850
<b>descripción</b>	placa electrónica control temporizado		
<b>Para modelos:</b>	PRESSY 33, PRESSY 45		

## teclados

### membranas de teclado



1

<b>código</b>	401269	<b>referencia</b>	73523970
<b>descripción</b>	membrana de teclado		
<b>Para modelos:</b>	PIZZY MONO 60.60		



1

<b>código</b>	401270	<b>referencia</b>	73523980
<b>descripción</b>	membrana de teclado		
<b>Para modelos:</b>	PIZZY DUO 60.60		



1

<b>código</b>	401284	<b>referencia</b>	767002R0
<b>descripción</b>	membrana de teclado		



1

<b>código</b>	401276	<b>referencia</b>	767000G0
<b>descripción</b>	membrana de teclado amarillo		
<b>Para modelos:</b>	AHB, AHC, AHC 18A, AHC 18B, AHC 18C, AHK, MHC 18A, MHC 18B, MHC 18C, MHC 30A, MHC 30B, MHC 30C, MHK - MHC - MHB		





1

<b>código</b>	401281	<b>referencia</b>	767001G0
<b>descripción</b>	membrana de teclado amarillo		
<b>Para modelos:</b>	MHC 18PA, MHC 18PB, MHC 18PC, MHC 30PA, MHC 30PB, MHC 30PC, MHK - MHC - MHB		

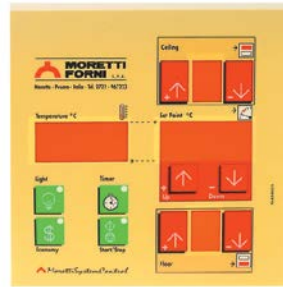

1

<b>código</b>	401275	<b>referencia</b>	767000C0
<b>descripción</b>	membrana de teclado beige		
<b>Para modelos:</b>	AHB, AHC, AHC 18A, AHC 18B, AHC 18C, AHK, MHC 18A, MHC 18B, MHC 18C, MHC 30A, MHC 30B, MHC 30C, MHK - MHC - MHB, RHC 18B, RHC 18C, RHC 18D, RHC 25B, RHC 25C, RHC-25D, RHK - RHC - RHB		



1

<b>código</b>	401274	<b>referencia</b>	767000B0
<b>descripción</b>	membrana de teclado azul		
<b>Para modelos:</b>	AHB, AHC, AHC 18A, AHC 18B, AHC 18C, AHK, MHC 18A, MHC 18B, MHC 18C, MHC 30A, MHC 30B, MHC 30C, MHK - MHC - MHB		

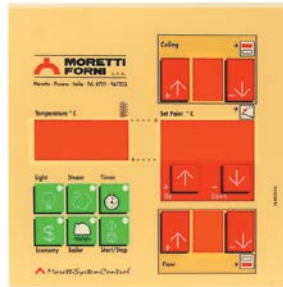

1

<b>código</b>	401280	<b>referencia</b>	767001C0
<b>descripción</b>	membrana de teclado beige		
<b>Para modelos:</b>	MHC 18PA, MHC 18PB, MHC 18PC, MHC 30PA, MHC 30PB, MHC 30PC, MHK - MHC - MHB, RHC 18PB, RHC 18PC, RHC 18PD, RHC 25PB, RHC 25PC, RHC 25PD, RHK - RHC - RHB		



1

<b>código</b>	401279	<b>referencia</b>	767001B0
<b>descripción</b>	membrana de teclado azul		
<b>Para modelos:</b>	MHC 18PA, MHC 18PB, MHC 18PC, MHC 30PA, MHC 30PB, MHC 30PC, MHK - MHC - MHB		

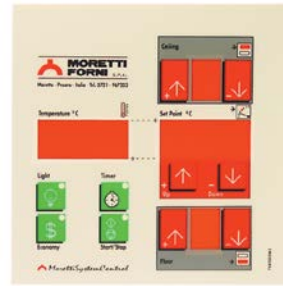

1

<b>código</b>	401273	<b>referencia</b>	767000W0
<b>descripción</b>	membrana de teclado blanco		
<b>Para modelos:</b>	AHB, AHC, AHC 18A, AHC 18B, AHC 18C, AHK, MHC 18A, MHC 18B, MHC 18C, MHC 30A, MHC 30B, MHC 30C, MHK - MHC - MHB		

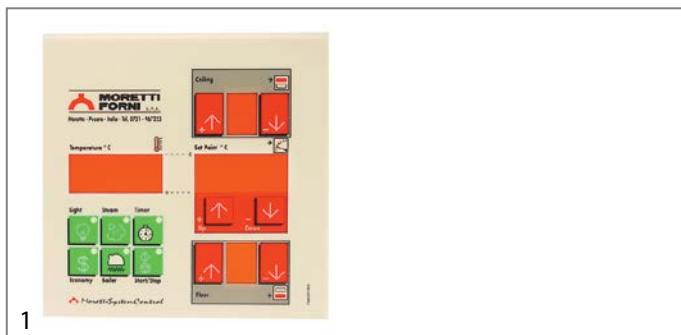

<b>código</b>	401278	<b>referencia</b>	767001W0
<b>descripción</b>	membrana de teclado blanco		
<b>Para modelos:</b>	MHC 18PA, MHC 18PB, MHC 18PC, MHC 30PA, MHC 30PB, MHC 30PC, MHK - MHC - MHB		

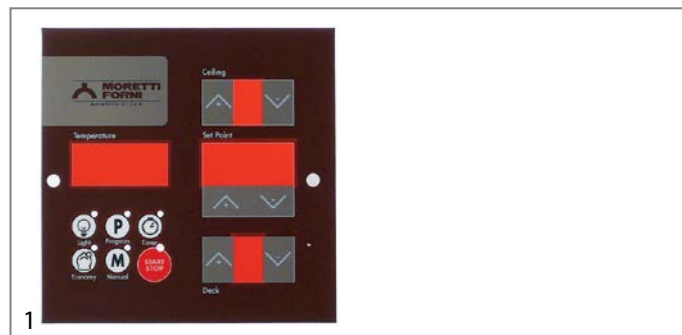

<b>código</b>	401277	<b>referencia</b>	767000R0 767003R0
<b>descripción</b>	membrana de teclado marrón		
<b>Para modelos:</b>	AHB, AHC, AHC 18A, AHC 18B, AHC 18C, AHK, MHC 18A, MHC 18B, MHC 18C, MHC 30A, MHC 30B, MHC 30C, MHK - MHC - MHB		

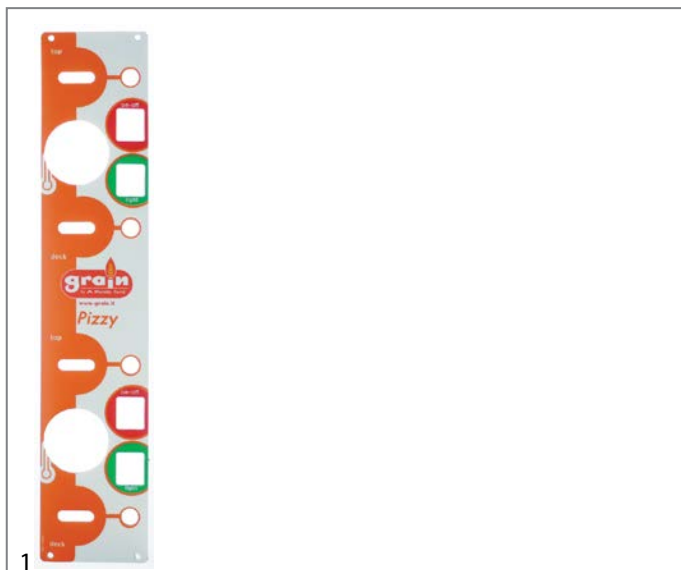

<b>código</b>	402352	<b>referencia</b>	73500510
<b>descripción</b>	membrana de teclado horno de pizza PIZZY DUO modelo DUO L 550mm An 111mm		
<b>Para modelos:</b>	PIZZY DUO 105.105, PIZZY DUO 105.65, PIZZY DUO 60.60, PIZZY DUO 65.105		



<b>código</b>	401282	<b>referencia</b>	767001R0
<b>descripción</b>	membrana de teclado marrón		
<b>Para modelos:</b>	MHC 18PA, MHC 18PB, MHC 18PC, MHC 30PA, MHC 30PB, MHC 30PC, MHK - MHC - MHB		

teclados de membrana



<b>código</b>	403141	<b>referencia</b>	767002R0
<b>descripción</b>	membrana de teclado L 140mm An 140mm		
<b>Para modelos:</b>	P110 GAS, P110 GAS A, P110 GAS B, PC/GAS		



<b>código</b>	401286	<b>referencia</b>	74311230
<b>descripción</b>	teclado de membrana		
<b>Para modelos:</b>	T75E, T75G, T97E, T97G		



## ventiladores

## motores de aire caliente

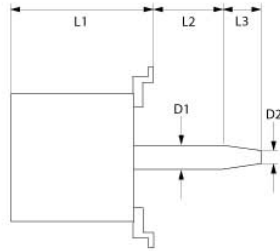

1

<b>código</b>	601240	<b>referencia</b>	74015370
<b>descripción</b>	motor de ventilador 230/400V fases 3 50Hz 0.55kW 1400rev/min velocidades 1 L1 150mm L2 45mm L3 47mm D1 ø 24mm D2 ø 20mm M8I F 3/1,73A Cos(fi) 0.75 a 50 Hz 1400rev/min tipo 1022		
<b>Para modelos:</b>	T75E, T97E		



1

<b>código</b>	601242	<b>referencia</b>	72807520
<b>descripción</b>	rodete ventilador D1 ø 300mm H1 100mm palas 12 D2 ø 19.5mm D3 ø 23mm H2 46mm		
<b>Para modelos:</b>	T97E		



1

<b>código</b>	601241	<b>referencia</b>	72806860
<b>descripción</b>	rodete ventilador D1 ø 300mm H1 100mm palas 20 D2 ø 19.5mm D3 ø 23mm H2 46mm		
<b>Para modelos:</b>	T75E, T75G		



1

<b>código</b>	601239	<b>referencia</b>	72806990
<b>descripción</b>	rodete ventilador para refrigeración motor		
<b>Para modelos:</b>	T75E, T75G, T97E, T97G		

## motores

## motorreductores

## para hornos

## por cinta transportadora



1

<b>código</b>	500820	<b>referencia</b>	74015590
<b>descripción</b>	motorreductor TRANSTECNO tipo WM26/P522CD 24V 4.3rev/min árbol ø 12mm L 210mm An 95mm H 160mm para banda transportadora		
<b>Para modelos:</b>	T97E, T97G		



1

<b>código</b>	500819	<b>referencia</b>	74015580
<b>descripción</b>	motorreductor TRANSTECNO tipo WMP26/522 CD-T 75E 70W 24V árbol ø 12mm L 215mm An 150mm H 100mm para banda transportadora		
<b>Para modelos:</b>	T75E, T75G		

para chimeneas



<b>código</b>	601467	<b>referencia</b>	74310970
<b>descripción</b>	motorreductor CROUZET tipo 823440 3W 230V 50Hz 6rev/min árbol ø 4mm L 65mm An 51mm H 34mm		
<b>Para modelos:</b>	BAKY 5TE, BAKY 5TM		
<b>accesorios para</b>	601467		
	<b>código</b>	<b>referencia</b>	—
	691422		
	rueda dentada para motor apto para TURBOCHEF C3		

motores

universal

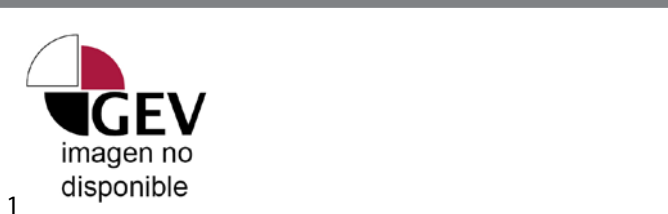

<b>código</b>	500822	<b>referencia</b>	74015350
<b>descripción</b>	motor		
<b>Para modelos:</b>	PRESSY 33, PRESSY 45		



<b>código</b>	500821	<b>referencia</b>	74015340
<b>descripción</b>	motor 370W 230V 50Hz fases 1 árbol ø 14mm brida ø 160mm 1400rev/min ø 140mm H 180mm L 220mm ICME 0.37kW		
<b>Para modelos:</b>	PRESSY 33		



<b>código</b>	500822	<b>referencia</b>	74015350
<b>descripción</b>	motor		
<b>Para modelos:</b>	PRESSY 33, PRESSY 45		

accesorios eléctricos

terminales

regletas de bornes a tornillo/con contactos de enchufe

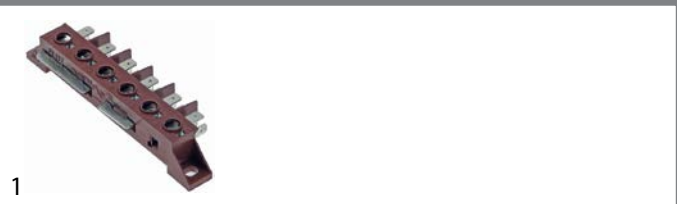

<b>código</b>	550411	<b>referencia</b>	74610340
<b>descripción</b>	borne de conexión 6 polos máx. 40A máx. 450V empalme ø6mm <sup>2</sup> / F6,3 resis.a la temp. 150°C sección nominal 6mm <sup>2</sup>		
<b>Para modelos:</b>	AHB, AHC, AHK, BAKY 5TE, BAKY 5TM, KR 6, KR 66, KR 66T, KR 6T, KR 9, KR 99, KRX 6, KRX 66, KRX 66T, KRX 6T, KRX 9, KRX 99, MHK - MHC - MHB, PIZZY DUO 105.105, PIZZY DUO 105.65, PIZZY DUO 65.105, PIZZY MONO 105.105, PIZZY MONO 105.65, PIZZY MONO 65.105, R08G GAS, R14G GAS, RHK - RHC - RHB, TEVERE HI-TECH, TREVI ELETRICO		

placas de bornes



<b>código</b>	550985	<b>referencia</b>	74670620
<b>descripción</b>	placa de bornes 3 polos rosca M6 L 83mm An 53mm		
<b>Para modelos:</b>	KR 4, KR 44, KRX 4, KRX 44, PIZZY DUO 60.60, PIZZY MONO 60.60		

bloques de bornes

WIELAND

bloques de bornes tipo 9700A

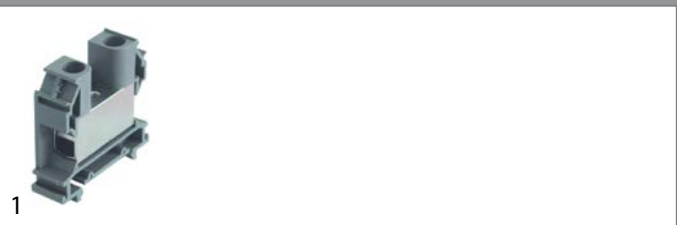

<b>código</b>	550376	<b>referencia</b>	74610020
<b>descripción</b>	borne seccionable WIELAND tipo 9700A/16 S35 2,5-35mm <sup>2</sup> riel de sombrero 35mm gris An 16mm L 59mm		
<b>Para modelos:</b>	AHB, AHC, AHK, KR 66, KR 66T, KR 99, KRX 66, KRX 66T, KRX 99, MHK - MHC - MHB, PIZZY DUO 105.105, PIZZY DUO 105.65, PIZZY DUO 65.105, RHK - RHC - RHB		



			
1			
<b>código</b>	550381	<b>referencia</b>	74610070
<b>descripción</b>	borne seccionable WIELAND tipo 9700A/8 S35 1,0-10mm <sup>2</sup> riel de sombrero 35mm gris An 8mm L 46.6mm		
<b>Para modelos:</b>	KRX 99, PIZZY DUO 105.105, PIZZY DUO 105.65		

			
1			
<b>código</b>	550416	<b>referencia</b>	74610190
<b>descripción</b>	borne seccionable WIELAND tipo 9700A/8 SL2 S35 1,0-10mm <sup>2</sup> riel de sombrero 35mm amarillo/verde An 8mm L 53mm		
<b>Para modelos:</b>	AHB, AHC, AHK, KR 66, KR 66T, KR 99, KRX 66, KRX 66T, KRX 99, MHK - MHC - MHB, PIZZY DUO 105.105, PIZZY DUO 105.65, PIZZY DUO 65.105, RHK - RHC - RHB		

accesorios en general

bornes finales



			
1			
<b>código</b>	550984	<b>referencia</b>	74610080
<b>descripción</b>	borne final para barra DIN		
<b>Para modelos:</b>	KR 66, KR 66T, KR 99, KRX 66, KRX 66T, KRX 99, PIZZY DUO 105.105, PIZZY DUO 105.65, PIZZY DUO 65.105		

## válvulas de gas y centralitas de gas automáticas

### válvulas de control de gas

#### HONEYWELL



			
1			
<b>código</b>	106011	<b>referencia</b>	74311120
<b>descripción</b>	válvula de gas HONEYWELL		
<b>Para modelos:</b>	P110 GAS, P110 GAS A, P110 GAS B, R08G GAS		
<b>accesorios para</b>	106011		
	<b>código</b>	101305	<b>referencia</b> —
	empalme de gas recto 1/2" brida 45x45mm ELETTROSIT/V4400/4600/4605 para SIT/HONEYWELL dist. del agujero 36x36mm		
	<b>código</b>	101306	<b>referencia</b> —
	empalme de gas acodado brida 45x45mm dist. del agujero 36x36mm 1/2" ELETTROSIT/V4400/4600/4605 atornillado con junta tórica para SIT/HONEYWELL		
	<b>código</b>	101307	<b>referencia</b> —
	empalme de gas recto brida 45x45mm dist. del agujero 36x36mm 3/4" ELETTROSIT/V4400/4600/4605 atornillado con junta tórica para SIT/HONEYWELL		
	<b>código</b>	101308	<b>referencia</b> —
	empalme de gas acodado brida 45x45mm dist. del agujero 36x36mm 3/4" ELETTROSIT/V4400/4600/4605 atornillado con junta tórica para SIT/HONEYWELL		

			
1			
<b>código</b>	106010	<b>referencia</b>	74310690
<b>descripción</b>	válvula de gas tipo VR4605A 230V 50Hz entrada gas brida 45x45mm salida gas 1/2" conexión termopar conexión de piloto margen de presión 3-37mbar tipo de operador 220/240V (V404A 1071 4) tipo de regulación V5306E 1143 1 apto para HONEYWELL		
<b>Para modelos:</b>	PC/GAS, R14G GAS, TEVERE HI-TECH, TIVOLI GAS HI-TECH, TREVIGAS		
<b>accesorios para</b>	106010		
	<b>código</b>	101305	<b>referencia</b> —
	empalme de gas recto 1/2" brida 45x45mm ELETTROSIT/V4400/4600/4605 para SIT/HONEYWELL dist. del agujero 36x36mm		
	<b>código</b>	101306	<b>referencia</b> —
	empalme de gas acodado brida 45x45mm dist. del agujero 36x36mm 1/2" ELETTROSIT/V4400/4600/4605 atornillado con junta tórica para SIT/HONEYWELL		

Continúa en la página siguiente







accesorios para	106010		
	código	101307	referencia —
	empalme de gas recto brida 45x45mm dist. del agujero 36x36mm 3/4" ELETTROSIT/V4400/4600/4605 atornillado con junta tórica para SIT/HONEYWELL		
	código	101308	referencia —
	empalme de gas acodado brida 45x45mm dist. del agujero 36x36mm 3/4" ELETTROSIT/V4400/4600/4605 atornillado con junta tórica para SIT/HONEYWELL		

1 			
código	102357	referencia	74110210
descripción	electrodo de encendido longitud brida 23mm anchura brida 15mm D1 ø 7mm D2 ø 8mm L1 19mm L2 10mm L3 37mm L4 15mm LC1 17mm LC2 17mm LC3 140mm LC4 60mm empalme F 4,8x0,8mm longitud del cable 1650mm medida de sujeción ø5x4mm con brida		
Para modelos:	P110 GAS, P110 GAS A, P110 GAS B		

centralitas de gas automáticas

HONEYWELL



1			
código	102358	referencia	74670690
descripción	centralita de gas automática HONEYWELL tipo S4570AS 1012 electrodos 1 tiempo de espera 3s tiempo de seguridad 5s 220-240V 10VA 50Hz		
Para modelos:	PC/GAS, R14G GAS, TEVERE HI-TECH, TIVOLI GAS HI-TECH, TREVI GAS		
accesorios para	102358		
	código	550800	referencia —
	borne para placa de circuito impreso 2 polos medida reticular 5mm		
	código	550801	referencia —
	borne para placa de circuito impreso 3 polos medida reticular 5mm		

1 			
código	102355	referencia	74110060
descripción	electrodo de encendido longitud brida 23mm anchura brida 15mm D1 ø 7mm D2 ø 8mm L1 19mm L2 10mm L3 37mm LC1 17mm LC2 17mm LC3 140mm LC4 60mm empalme F 6,3 longitud del cable 1650mm medida de sujeción ø5x4mm con brida		
Para modelos:	PC/GAS, R14G GAS, TEVERE HI-TECH, TIVOLI GAS HI-TECH, TREVI GAS		

encendidos y tempares

electródos

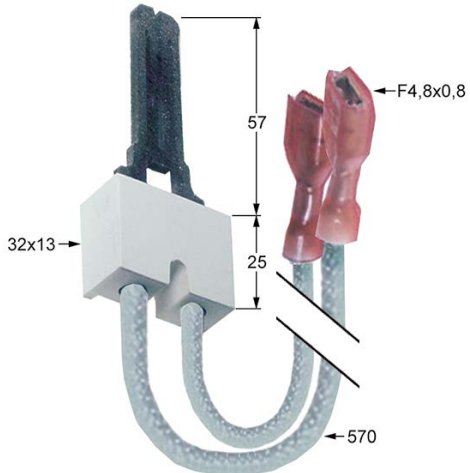
1 			
código	102354	referencia	74110050 Q3271N1005B
descripción	electrodo de encendido D1 ø 32x13mm L1 57mm LC1 25mm empalme F 4,8x0,8mm longitud del cable 570mm		
Para modelos:	PC/GAS, R14G GAS, TEVERE HI-TECH, TIVOLI GAS HI-TECH, TREVI GAS		

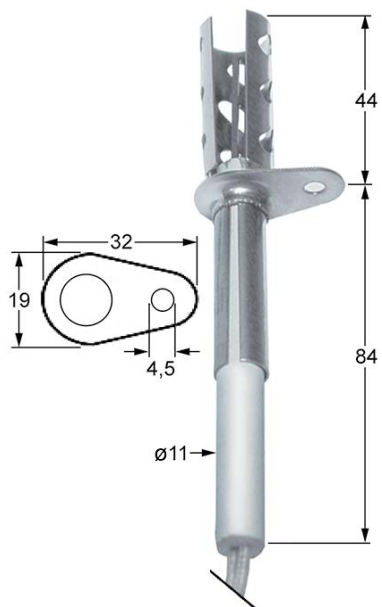
1 			
código	102356	referencia	74100260
descripción	electrodo de encendido longitud brida 32mm anchura brida 19mm D1 ø 11mm L1 44mm L2 32mm LC1 8mm LC2 84mm longitud del cable 870mm medida de sujeción ø4,5mm con brida		
Para modelos:	P110 GAS, P110 GAS A, P110 GAS B, R08G GAS		

boquillas de gas

inyectores principales

boquillas de gas M 13x1

1 			
código	102471	referencia	72093460
descripción	boquilla de gas rosca M13x1 taladro ø 2,3mm EC 13		
Para modelos:	R14G GAS		

## componentes específicos

### para amasadoras

#### gancho amasador

#### con lengüeta de sujeción



<b>código</b>	697113	<b>referencia</b>	71336030C 72701100
<b>descripción</b>	gancho amasador SP20		
<b>Para modelos:</b>	SP20		

### para extendedoras de masa



#### rodillos



<b>código</b>	693909	<b>referencia</b>	72601110
<b>descripción</b>	rodillo L 422mm ø 48mm pos. de montaje abajo delante		
<b>Para modelos:</b>	FLATTY 40, FLATTY 40 P		

#### soportes



<b>código</b>	692301	<b>referencia</b>	72003620 72004100 72500990 73601110
<b>descripción</b>	palanca completo agujero ø 9.8mm H 21mm dist. del agujero 32mm		
<b>repuestos para</b>	692301		
	<b>código</b>	697346	<b>referencia</b> —
	pomo esférico rosca M4 ø 20mm negro		
<b>accesorios para</b>	692301		
	<b>código</b>	691637	<b>referencia</b> 72500920
	pasador elástico ø 3mm L 20mm		

### para formadoras de pizzas

#### mecanismo



<b>código</b>	693424	<b>referencia</b>	74015330
<b>descripción</b>	mecanismo		
<b>Para modelos:</b>	PRESSY 33, PRESSY 45		

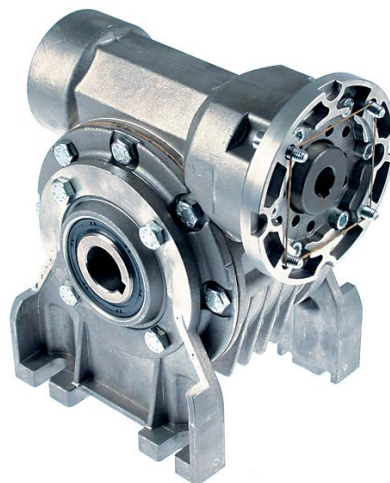

<b>código</b>	601182	<b>referencia</b>	74015320
<b>descripción</b>	mecanismo ø árbol motor 14mm brida ø 105mm transmisión 1/80 árbol motriz ø 25mm medida de sujeción 86-110mm tipo MV 63A		



<b>código</b>	693423	<b>referencia</b>	74015320
<b>descripción</b>	mecanismo ø árbol motor 14mm brida ø 105mm transmisión 1/80 árbol motriz ø 25mm medida de sujeción 86-110mm tipo MV 63A		
<b>Para modelos:</b>	PRESSY 33		

para horno con cinta transportadora

otros



<b>código</b>	693419	<b>referencia</b>	72091850
<b>descripción</b>	acoplamiento pos. de montaje lado del motor		
<b>Para modelos:</b>	T75E, T75G, T97E, T97G		

para hornos de pizza

recambios y accesorios



<b>código</b>	693420	<b>referencia</b>	72601390
<b>descripción</b>	acoplamiento centrado para horno de pizza		
<b>Para modelos:</b>	T75E, T75G, T97E, T97G		



<b>código</b>	693421	<b>referencia</b>	72094440
<b>descripción</b>	acoplamiento lateral para horno de pizza		
<b>Para modelos:</b>	T75E, T75G, T97E, T97G		

vidrios



<b>código</b>	693412	<b>referencia</b>	73700680 73700850
<b>descripción</b>	vidrio L 385mm An 135mm espesor 5mm rectangular con junta		
<b>Para modelos:</b>	KR 4, KR 44, KR 6, KR 66, KRX 4, KRX 44, KRX 6, KRX 66, MHC 18A, MHC 18B, MHC 18PA, MHC 18PB, MHK - MHC - MHB, PC/GAS, PIZZY DUO 60.60, PIZZY DUO 65.105, PIZZY MONO 60.60, PIZZY MONO 65.105, RHC 18B, RHC 18C, RHC 18D, RHC 18PB, RHC 18PC, RHC 18PD, RHK - RHC - RHB, T75E, T75G, T97E, T97G		



<b>código</b>	693413	<b>referencia</b>	73700870
<b>descripción</b>	vidrio L 385mm An 163mm espesor 5mm rectangular		
<b>Para modelos:</b>	AHC 18A, AHC 18B, AHC 18C, AHK, MHC 30A, MHC 30B, MHC 30PA, MHC 30PB, MHK - MHC - MHB, RHC 25B, RHC 25C, RHC 25PB, RHC 25PC, RHC 25PD, RHC-25D, RHK - RHC - RHB		



<b>código</b>	693414	<b>referencia</b>	73700840
<b>descripción</b>	vidrio L 697mm An 135mm espesor 5mm rectangular		
<b>Para modelos:</b>	KR 66T, KR 6T, KR 9, KR 99, KRX 66T, KRX 6T, KRX 9, KRX 99, MHC 18C, MHC 18PC, MHK - MHC - MHB, P110 GAS, P110 GAS A, P110 GAS B, PC/GAS, PIZZY DUO 105.105, PIZZY DUO 105.65, PIZZY MONO 105.105, PIZZY MONO 105.65		



<b>código</b>	693415	<b>referencia</b>	73700860
<b>descripción</b>	vidrio L 697mm An 163mm espesor 5mm rectangular		
<b>Para modelos:</b>	AHB, AHC, AHC 18A, AHC 18B, AHC 18C, MHC 30C, MHC 30PC, MHK - MHC - MHB		

losas de chamota



<b>código</b>	850108	<b>referencia</b>	49100030 76000090
<b>descripción</b>	losa de chamota L 1056mm An 526mm H 14mm tipo de envío ausschließlích per Spedition		
<b>Para modelos:</b>	KR 9, KR 99, KRX 9, KRX 99, PIZZY DUO 105.105, PIZZY MONO 105.105		



1

<b>código</b>	850070	<b>referencia</b>	76001230 76002780
<b>descripción</b>	losa de chamota L 1100mm An 369mm H 20mm pos. de montaje arriba tipo de envío ausschließlich per Spedition		
<b>Para modelos:</b>	P110 GAS, P110 GAS A, P110 GAS B		



1

<b>código</b>	850073	<b>referencia</b>	76000130 76002210
<b>descripción</b>	losa de chamota L 1100mm An 528mm H 13mm tipo de envío ausschließlich per Spedition		
<b>Para modelos:</b>	PIZZY DUO 105.105, PIZZY MONO 105.105		



1

<b>código</b>	850076	<b>referencia</b>	76000240 76002240
<b>descripción</b>	losa de chamota L 1300mm An 415mm H 15mm tipo de envío ausschließlich per Spedition		
<b>Para modelos:</b>	RHC 18B, RHC 18C, RHC 18D, RHC 18PB, RHC 18PC, RHC 18PD, RHC 25B, RHC 25C, RHC 25PB, RHC 25PC, RHC 25PD, RHC-25D, RHK - RHC - RHB		



1

<b>código</b>	850067	<b>referencia</b>	76001650 76001660
<b>descripción</b>	losa de chamota L 600mm An 425mm H 15mm tipo de envío ausschließlich per Spedition		
<b>Para modelos:</b>	PC/GAS		



1

<b>código</b>	850066	<b>referencia</b>	76002690
<b>descripción</b>	losa de chamota L 600mm An 425mm H 20mm tipo de envío ausschließlich per Spedition		
<b>Para modelos:</b>	PC/GAS		



1

<b>código</b>	850077	<b>referencia</b>	76000190 76001730
<b>descripción</b>	losa de chamota L 605mm An 415mm H 15mm tipo de envío ausschließlich per Spedition		
<b>Para modelos:</b>	MHC 18A, MHC 18B, MHC 18PA, MHC 18PB, MHC 30A, MHC 30B, MHC 30PA, MHC 30PB, MHK - MHC - MHB		



1

<b>código</b>	850071	<b>referencia</b>	76000500 76002160 76003260
<b>descripción</b>	losa de chamota L 615mm An 330mm H 15mm tipo de envío ausschließlich per Spedition		
<b>Para modelos:</b>	PIZZY DUO 60.60, PIZZY MONO 60.60		

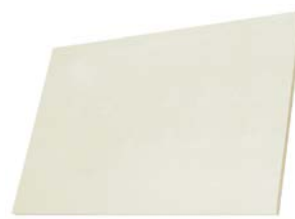

1

<b>código</b>	850074	<b>referencia</b>	76000180 76001740
<b>descripción</b>	losa de chamota L 650mm An 415mm H 15mm tipo de envío ausschließlich per Spedition		
<b>Para modelos:</b>	RHC 18B, RHC 18C, RHC 18D, RHC 18PB, RHC 18PC, RHC 18PD, RHC 25B, RHC 25C, RHC 25PB, RHC 25PC, RHC 25PD, RHC-25D, RHK - RHC - RHB		



			
1			
<b>código</b>	850106	<b>referencia</b>	49100050 76000120
<b>descripción</b>	losa de chamota L 660mm An 307mm H 14mm tipo de envío ausschließlich per Spedition		
<b>Para modelos:</b>	KR 4, KR 44, KRX 4, KRX 44, PIZZY DUO 60.60, PIZZY MONO 60.60		

			
1			
<b>código</b>	850107	<b>referencia</b>	49100040 76000110
<b>descripción</b>	losa de chamota L 660mm An 526mm H 14mm tipo de envío ausschließlich per Spedition		
<b>Para modelos:</b>	KR 6, KR 66, KR 66T, KR 6T, KRX 6, KRX 66, KRX 66T, KRX 6T, PIZZY DUO 105.65, PIZZY DUO 65.105, PIZZY MONO 105.65, PIZZY MONO 65.105		

			
1			
<b>código</b>	850072	<b>referencia</b>	76002140 76003270
<b>descripción</b>	losa de chamota L 665mm An 336mm H 15mm tipo de envío ausschließlich per Spedition		
<b>Para modelos:</b>	PIZZY DUO 65.105, PIZZY MONO 65.105		

			
1			
<b>código</b>	850111	<b>referencia</b>	76000060
<b>descripción</b>	losa de chamota L 700mm An 528mm H 14mm tipo de envío ausschließlich per Spedition		
<b>Para modelos:</b>	PIZZY DUO 105.65, PIZZY MONO 105.65		

			
1			
<b>código</b>	850069	<b>referencia</b>	76001670 76001680
<b>descripción</b>	losa de chamota L 800mm An 425mm H 15mm tipo de envío ausschließlich per Spedition		
<b>Para modelos:</b>	PC/GAS		

			
1			
<b>código</b>	850068	<b>referencia</b>	76002710
<b>descripción</b>	losa de chamota L 800mm An 425mm H 20mm tipo de envío ausschließlich per Spedition		
<b>Para modelos:</b>	PC/GAS		

			
1			
<b>código</b>	850078	<b>referencia</b>	76000200 76001720
<b>descripción</b>	losa de chamota L 805mm An 415mm H 15mm tipo de envío ausschließlich per Spedition		
<b>Para modelos:</b>	MHC 18C, MHC 18PC, MHC 30C, MHC 30PC, MHK - MHC - MHB		

			
1			
<b>código</b>	850075	<b>referencia</b>	76000210 76001750
<b>descripción</b>	losa de chamota L 850mm An 415mm H 15mm tipo de envío ausschließlich per Spedition		
<b>Para modelos:</b>	RHC 18B, RHC 18C, RHC 18D, RHC 18PB, RHC 18PC, RHC 18PD, RHC 25B, RHC 25C, RHC 25PB, RHC 25PC, RHC 25PD, RHC-25D, RHK - RHC - RHB		



## otros



1

<b>código</b>	690992	<b>referencia</b>	46003060 71000310
<b>descripción</b>	bisagra de puerta		
<b>Para modelos:</b>	AHB, AHC, AHK, KRX 4, KRX 44, MHK - MHC - MHB, P110 GAS A, P110 GAS B, PIZZY DUO 105.65, PIZZY DUO 60.60, PIZZY MONO 105.65, PIZZY MONO 60.60, RHK - RHC - RHB		



1

<b>código</b>	514420	<b>referencia</b>	46003070 71000300
<b>descripción</b>	bisagra de puerta L 76mm An 30mm pos. de montaje izquierdo espesor 30mm para horno de pizza		
<b>Para modelos:</b>	AHB, AHC, AHK, MHK - MHC - MHB, P110 GAS A, P110 GAS B, PIZZY DUO 105.105, PIZZY DUO 105.65, PIZZY DUO 65.105, PIZZY MONO 105.105, PIZZY MONO 105.65, PIZZY MONO 65.105, RHK - RHC - RHB		

## ruedas dentadas



1

<b>código</b>	693418	<b>referencia</b>	71901030
<b>descripción</b>	rueda dentada dientes 11 soporte de eje $\varnothing$ 20mm $\varnothing$ 50mm $\varnothing$ cubomm acero inoxidable		
<b>Para modelos:</b>	T75E, T75G, T97E, T97G		

## pomos

## pomos personalizados para fabricantes

## MORETTI



1

<b>código</b>	112944	<b>referencia</b>	73600140
<b>descripción</b>	pomo 1-10 T $\text{máx}^{\circ}\text{C}^{\circ}\text{C}$ $\varnothing$ 50mm eje $\varnothing$ 6x4,6mm parte plana abajo plata		
<b>Para modelos:</b>	KR 66T, KR 6T, KR 9, KR 99, KRX 4, KRX 44, KRX 6, KRX 66, KRX 66T, KRX 6T, KRX 9, KRX 99		



1

<b>código</b>	111769	<b>referencia</b>	72800360
<b>descripción</b>	pomo termostato 1-10 $\varnothing$ 54mm eje $\varnothing$ 6x4,6mm parte plana abajo		
<b>Para modelos:</b>	PIZZY DUO 105.105, PIZZY DUO 105.65, PIZZY DUO 60.60, PIZZY DUO 65.105, PIZZY MONO 105.105, PIZZY MONO 105.65, PIZZY MONO 60.60, PIZZY MONO 65.105, PRESSY 33, PRESSY 45, PRESSY 50		



1

<b>código</b>	112940	<b>referencia</b>	73600130
<b>descripción</b>	pomo termostato 1-10 T $\text{máx}^{\circ}\text{C}^{\circ}\text{C}$ $\varnothing$ 50mm eje $\varnothing$ 6x4,6mm parte plana abajo negro		
<b>Para modelos:</b>	KR 4, KR 44, KR 6, KR 66, KR 66T, KR 6T, KR 9, KR 99		



1

<b>código</b>	111467	<b>referencia</b>	72808120
<b>descripción</b>	pomo termostato 1-10 T $\text{máx}^{\circ}\text{C}^{\circ}\text{C}$ $\varnothing$ 54mm eje $\varnothing$ 6x4,6mm parte plana abajo		



1

<b>código</b>	112941	<b>referencia</b>	73601100
<b>descripción</b>	pomo termostato T $\text{máx}^{\circ}\text{C}^{\circ}\text{C}$ $\varnothing$ 50mm eje $\varnothing$ 6x4,6mm parte plana abajo negro margen de trabajo 50-500 $^{\circ}\text{C}$ ángulo de rotación 270 $^{\circ}$		
<b>Para modelos:</b>	KR 4, KR 44, KR 6, KR 66		



## manillas y volantes

### manillas cilíndricas

fijo



1

<b>código</b>	112943	<b>referencia</b>	73600750
<b>descripción</b>	manilla cilíndrica rosca M10 ø 27mm L 91mm		
<b>Para modelos:</b>	KR 4, KR 44, PIZZY DUO 105.105, PIZZY DUO 105.65, PIZZY DUO 60.60, PIZZY DUO 65.105, PIZZY MONO 105.105, PIZZY MONO 105.65, PIZZY MONO 60.60, PIZZY MONO 65.105, TIVOLI EL HI-TECH, TIVOLI GAS HI-TECH		



1

<b>código</b>	110803	<b>referencia</b>	73601180
<b>descripción</b>	manilla cilíndrica rosca M12 ø 29mm L 87mm		

### manillas cónicas



1

<b>código</b>	112942	<b>referencia</b>	73600470
<b>descripción</b>	manilla cónica rosca M10 ø 29mm L 67mm plástico negro		
<b>Para modelos:</b>	KR 4, KR 44, KR 6, KR 66, KR 66T, KR 6T, KR 9, KR 99		



1



<b>código</b>	693935	<b>referencia</b>	769002B0
<b>descripción</b>	manilla de puerta rosca M14 azul completo		

## palancas

### sin manilla



1

<b>código</b>	691477	<b>referencia</b>	72000860	
<b>descripción</b>	barra de asidero rosca M10			
<b>Para modelos:</b>	KR 4, KR 44, KR 6, KR 66, KR 66T, KR 6T, KR 9, KR 99			
<b>accesorios para</b>	691477			
	<b>código</b>	112942	<b>referencia</b>	73600470
	<b>descripción</b>	manilla cónica rosca M10 ø 29mm L 67mm plástico negro		
	<b>código</b>	112943	<b>referencia</b>	73600750
	<b>descripción</b>	manilla cilíndrica rosca M10 ø 27mm L 91mm		

## accesorios

### otros



1

<b>código</b>	524876	<b>referencia</b>	72087030
<b>descripción</b>	perno roscado para asidero ø 15mm G1: M10x1,5 G2: M14x2 longitud total 100mm		
<b>Para modelos:</b>	PIZZY DUO 105.105, PIZZY DUO 105.65, PIZZY DUO 60.60, PIZZY DUO 65.105, PIZZY MONO 105.105, PIZZY MONO 105.65, PIZZY MONO 60.60, PIZZY MONO 65.105, TIVOLI EL HI-TECH, TIVOLI GAS HI-TECH		

## cierres

### cierres de pestillo espagnolette

#### universal



1

<b>código</b>	690041	<b>referencia</b>	0751.02.0943 73600540
<b>descripción</b>	pestillo L 148mm distancia de sujeción 32mm		

### específicas del fabricante

#### MORETTI



1

<b>código</b>	692206	<b>referencia</b>	68000350
<b>descripción</b>	cierre de pestillo espagnolette completo		
<b>Para modelos:</b>	TREVI ELETTRICO, TREVI GAS		



<b>código</b>	692205	<b>referencia</b>	0751.02.0942 73600530
<b>descripción</b>	mecanismo de cierre soporte de eje ø 8x8mm L 170mm An 40mm H 30mm		



<b>código</b>	690041	<b>referencia</b>	0751.02.0943 73600540
<b>descripción</b>	pestillo L 148mm distancia de sujeción 32mm		

## bisagras

### soporte de puerta



<b>código</b>	690992	<b>referencia</b>	46003060 71000310
<b>descripción</b>	bisagra de puerta		
<b>Para modelos:</b>	AHB, AHC, AHK, KRX 4, KRX 44, MHK - MHC - MHB, P110 GAS A, P110 GAS B, PIZZY DUO 105.65, PIZZY DUO 60.60, PIZZY MONO 105.65, PIZZY MONO 60.60, RHK - RHC - RHB		



<b>código</b>	514420	<b>referencia</b>	46003070 71000300
<b>descripción</b>	bisagra de puerta L 76mm An 30mm pos. de montaje izquierdo espesor 30mm para horno de pizza		
<b>Para modelos:</b>	AHB, AHC, AHK, MHK - MHC - MHB, P110 GAS A, P110 GAS B, PIZZY DUO 105.105, PIZZY DUO 105.65, PIZZY DUO 65.105, PIZZY MONO 105.105, PIZZY MONO 105.65, PIZZY MONO 65.105, RHK - RHC - RHB		



<b>código</b>	700494	<b>referencia</b>	72005090
<b>descripción</b>	casquillo L 69mm pos. de montaje izquierdo ø 14.5mm int.ø 10mm para bisagra de puerta batiente UE 1 pzs		
<b>Para modelos:</b>	AHB, AHC, AHC 18A, AHC 18B, AHC 18C, AHK, MHC 18A, MHC 18B, MHC 18C, MHC 18PA, MHC 18PB, MHC 18PC, MHC 30A, MHC 30B, MHC 30C, MHC 30PA, MHC 30PB, MHC 30PC, MHK - MHC - MHB, P110 GAS, P110 GAS A, P110 GAS B, PC/GAS, RHC 18B, RHC 18C, RHC 18D, RHC 18PB, RHC 18PC, RHC 18PD, RHC 25B, RHC 25C, RHC 25PB, RHC 25PC, RHC 25PD, RHC-25D, RHK - RHC - RHB		



<b>código</b>	700496	<b>referencia</b>	72005100
<b>descripción</b>	casquillo pos. de montaje derecho para bisagra de puerta batiente		
<b>Para modelos:</b>	AHB, AHC, AHC 18A, AHC 18B, AHC 18C, AHK, MHC 18A, MHC 18B, MHC 18C, MHC 18PA, MHC 18PB, MHC 18PC, MHC 30A, MHC 30B, MHC 30C, MHC 30PA, MHC 30PB, MHC 30PC, MHK - MHC - MHB, P110 GAS, P110 GAS A, P110 GAS B, PC/GAS, PIZZY DUO 105.105, PIZZY DUO 105.65, PIZZY MONO 105.105, PIZZY MONO 105.65, PIZZY MONO 65.105		



<b>código</b>	700495	<b>referencia</b>	72083970
<b>descripción</b>	perno pos. de montaje izquierdo para bisagra de puerta batiente		
<b>Para modelos:</b>	AHB, AHC, AHC 18A, AHC 18B, AHC 18C, AHK, MHC 18A, MHC 18B, MHC 18C, MHC 18PA, MHC 18PB, MHC 18PC, MHC 30A, MHC 30B, MHC 30C, MHC 30PA, MHC 30PB, MHC 30PC, MHK - MHC - MHB, P110 GAS, P110 GAS A, P110 GAS B, PC/GAS, RHC 18B, RHC 18C, RHC 18D, RHC 18PB, RHC 18PC, RHC 18PD, RHC 25B, RHC 25C, RHC 25PB, RHC 25PC, RHC 25PD, RHC-25D, RHK - RHC - RHB		

## juntas

### cordones de junta

#### cuadrado



<b>código</b>	693416	<b>referencia</b>	56400120
<b>descripción</b>	junta de estopa rectangular tamaño 4x4mm L 0.09m UE 6 junta de motor		
<b>Para modelos:</b>	T75E, T75G, T97E, T97G		

## técnica de accionamiento y rodamientos de bolas

### rodamientos de bolas

#### cajinetes brida





<b>código</b>	693417	<b>referencia</b>	73801540
<b>descripción</b>	coinete de brida árbol ø 12mm An 38mm brida 2 orificios dist. del agujero 48mm H 20mm		
<b>Para modelos:</b>	T75E, T75G, T97E, T97G		



## muelles

### muelles de torsión

			
<b>código</b>	694238	<b>referencia</b>	72500440
<b>descripción</b>	resorte $\varnothing$ mm L2 80mm pos. de montaje anterior espesor de hilo 2mm FI32-FI42-FIP42 L1mm UE 1 pzs		

			
<b>código</b>	694239	<b>referencia</b>	72500320
<b>descripción</b>	resorte $\varnothing$ mm L2 80mm pos. de montaje atrás espesor de hilo 2mm FI32-FI42-FIP42 L1mm UE 1 pzs		

### resortes de compresión

			
<b>código</b>	693422	<b>referencia</b>	72501190
<b>descripción</b>	resorte de compresión $\varnothing$ 14.8mm L 52mm espesor de hilo 2.8mm		
<b>Para modelos:</b>	T75E, T75G, T97E, T97G		

			
<b>código</b>	514417	<b>referencia</b>	72500870
<b>descripción</b>	resorte de compresión $\varnothing$ 15mm L 40mm espesor de hilo 1.4mm		

			
<b>código</b>	514216	<b>referencia</b>	72500860
<b>descripción</b>	resorte de compresión $\varnothing$ 15mm L 60mm espesor de hilo 1.5mm		

### resortes de tracción

			
<b>código</b>	700493	<b>referencia</b>	72500660
<b>descripción</b>	muelle de tracción con rosca $\varnothing$ 29.8mm longitud total 230 extraíble max. 275mm espesor de hilo 4mm		
<b>Para modelos:</b>	AHC, AHC 18A, AHC 18B, AHC 18C, MHC 18C, MHC 18PC, MHC 30A, MHC 30B, MHC 30C, MHC 30PA, MHC 30PB, MHC 30PC, MHK - MHC - MHB, P110 GAS, P110 GAS A, P110 GAS B, PC/GAS		



			
<b>código</b>	700492	<b>referencia</b>	72500670
<b>descripción</b>	muelle de tracción $\varnothing$ 20mm longitud total 230mm espesor de hilo 2.8mm L1 125mm L2 55mm L3 50mm horno de pizza		
<b>Para modelos:</b>	AHC 18A, AHC 18B, AHC 18C, AHK, MHC 18A, MHC 18B, MHC 18PA, MHC 18PB, MHK - MHC - MHB, PC/GAS, PIZZY DUO 105.105, PIZZY DUO 105.65, PIZZY DUO 65.105, PIZZY MONO 105.105, PIZZY MONO 105.65, PIZZY MONO 65.105, RHC 18B, RHC 18C, RHC 18D, RHC 18PB, RHC 18PC, RHC 18PD, RHC 25B, RHC 25C, RHC 25PB, RHC 25PC, RHC 25PD, RHC-25D, RHK - RHC - RHB		

## sistemas de medición

### termómetros

#### termómetros incorporados

$\varnothing$ 60mm

			
			
<b>código</b>	541879	<b>referencia</b>	74220250
<b>descripción</b>	termómetro montaje $\varnothing$ 60mm 0 a +500°C sonda $\varnothing$ 8mm sonda L 155mm capilar 1000mm		
<b>Para modelos:</b>	KR 4, KR 44, KR 6, KR 66, KR 66T, KR 6T, KR 9, KR 99, PIZZY DUO 105.105, PIZZY DUO 105.65, PIZZY DUO 60.60, PIZZY DUO 65.105, PIZZY MONO 105.105, PIZZY MONO 105.65, PIZZY MONO 60.60, PIZZY MONO 65.105		

## materia de sujeción

### sujeciones

#### pasadores elásticos

			
<b>código</b>	691637	<b>referencia</b>	72500920
<b>descripción</b>	pasador elástico $\varnothing$ 3mm L 20mm		