



resistencias

resistencias para hornos de pizza







código	420176	referencia	RESI0078
descripción	resistencia 800W 230V L 1040mm An 98mm longitud brida 140mm anchura brida 25mm dist. del agujero 120mm longitud de empalme 120mm empalme conector Faston 6,3mm tubo ø 8.5mm espirales 1 sujeción 2 orificios pos. de montaje atrás agujero ø 6mm		



código	418116	referencia	RESI0051
descripción	resistencia 1000W 220V L 810mm An 214mm rosca M14x1,5 distancia de sujeción 205mm longitud de empalme 50mm tubo ø 8.6mm longitud del cable 520mm espirales 1 resistencia seca pos. de montaje atrás sujeción 2 orificios		
Para modelos:	T2 POLIS MC16, T2 POLIS MC26, T4 POLIS MC16, T4 POLIS MC26		
accesorios para	418116		
	código	510417	referencia —
		junta plana fibra ø ext. 20mm int.ø 14mm espesor 2mm UE 1 pzs	
	código	520228	referencia —
		arandela dentada int.ø 15.3mm ø ext. 24mm acero UE 1 pzs para rosca M14	
	código	520230	referencia —
		tuerca rosca M14x1,5 H 5mm EC 19 acero zincado UE 1 pzs	
	código	521101	referencia —
		tuerca rosca M14x1,5 H 5mm EC 19 inox UE 1 pzs	
	código	550262	referencia —
		junta plana cobre ø ext. 20mm int.ø 14mm espesor 2mm	



código	418113	referencia	RESI0068
descripción	resistencia 1000W 230V L 810mm An 100mm rosca M14x1,5 distancia de sujeción 86mm longitud de empalme 36mm tubo ø 8.5mm longitud del cable 1200mm espirales 1 resistencia seca pos. de montaje anterior sujeción 2 orificios		
Para modelos:	T2 POLIS MC16, T2 POLIS MC26, T4 POLIS MC16, T4 POLIS MC26		
repuestos para	418113		
	código	510417	referencia —
		junta plana fibra ø ext. 20mm int.ø 14mm espesor 2mm UE 1 pzs	
accesorios para	418113		
	código	520228	referencia —
		arandela dentada int.ø 15.3mm ø ext. 24mm acero UE 1 pzs para rosca M14	
	código	520230	referencia —
		tuerca rosca M14x1,5 H 5mm EC 19 acero zincado UE 1 pzs	
	código	521101	referencia —
		tuerca rosca M14x1,5 H 5mm EC 19 inox UE 1 pzs	
	código	550262	referencia —
		junta plana cobre ø ext. 20mm int.ø 14mm espesor 2mm	



código	415524	referencia	RESI00211
descripción	resistencia 1100W 230V L 720mm An 200mm rosca M14x1,5 distancia de sujeción 210mm longitud de empalme 40mm tubo ø 8.5mm longitud del cable 1000mm espirales 1 resistencia seca sujeción 2 orificios		
accesorios para	415524		
	código	361182	referencia —
		tuerca rosca 1/4" H 5mm latón niquelado EC 17 UE 1 pzs	
	código	510417	referencia —
		junta plana fibra ø ext. 20mm int.ø 14mm espesor 2mm UE 1 pzs	
	código	520228	referencia —
		arandela dentada int.ø 15.3mm ø ext. 24mm acero UE 1 pzs para rosca M14	
	código	550262	referencia —
		junta plana cobre ø ext. 20mm int.ø 14mm espesor 2mm	







código	415525	referencia	RESI0065
descripción	resistencia 1100W 380V L 716mm An 205mm rosca M15x1 distancia de sujeción 197mm longitud de empalme 40mm tubo ø 8mm longitud del cable 980mm espirales 1 resistencia seca sujeción 2 orificios		



código	418117	referencia	RESI0057
descripción	resistencia 1200W 230V espirales 1 pos. de montaje arriba L 147mm An 157mm L1 100mm ø 47mm rosca M14x1,5 distancia de sujeción 148mm longitud del cable 970mm tubo ø 8.5mm empalme cable resistencia seca sujeción 2 orificios		









código	418115	referencia	RESI0052
descripción	resistencia 1300W 220V L 1220mm An 250mm rosca M14x1,5 distancia de sujeción 252mm longitud de empalme 47mm tubo ø 8.5mm longitud del cable 1550mm resistencia seca pos. de montaje atrás sujeción 2 orificios		
Para modelos:	T3 POLIS MC16, T3 POLIS MC26, T6 POLIS MC16, T6 POLIS MC26		
accesorios para	418115		
	código	510417	referencia —
		junta plana fibra ø ext. 20mm int.ø 14mm espesor 2mm UE 1 pzs	
	código	520228	referencia —
		arandela dentada int.ø 15.3mm ø ext. 24mm acero UE 1 pzs para rosca M14	
	código	520230	referencia —
		tuerca rosca M14x1,5 H 5mm EC 19 acero zincado UE 1 pzs	
	código	521101	referencia —
		tuerca rosca M14x1,5 H 5mm EC 19 inox UE 1 pzs	

Continúa en la página siguiente



accesorios para	418115			
	código	550262	referencia	—
	junta plana cobre ø ext. 20mm int.ø 14mm espesor 2mm			





1 				
código	418114	referencia	RESI0069	
descripción	resistencia 1300W 230V L 1220mm An 100mm rosca M14x1,5 distancia de sujeción 92mm longitud de empalme 34mm tubo ø 8.5mm longitud del cable 1200mm espirales 1 resistencia seca pos. de montaje anterior sujeción 2 orificios			
Para modelos:	T3 POLIS MC16, T3 POLIS MC26, T6 POLIS MC16, T6 POLIS MC26			
accesorios para	418114			
	código	510417	referencia	—
	junta plana fibra ø ext. 20mm int.ø 14mm espesor 2mm UE 1 pzs			
	código	520228	referencia	—
	arandela dentada int.ø 15.3mm ø ext. 24mm acero UE 1 pzs para rosca M14			
	código	520230	referencia	—
	tuerca rosca M14x1,5 H 5mm EC 19 acero zincado UE 1 pzs			
	código	521101	referencia	—
	tuerca rosca M14x1,5 H 5mm EC 19 inox UE 1 pzs			
	código	550262	referencia	—
	junta plana cobre ø ext. 20mm int.ø 14mm espesor 2mm			

1 				
código	415527	referencia	RESI0022	
descripción	resistencia 1500W 220V L 720mm An 260mm rosca M14x1,5 distancia de sujeción 252mm tubo ø 8.5mm longitud del cable 1000mm espirales 1 resistencia seca sujeción 2 orificios			

1 				
código	418119	referencia	RESI0079	
descripción	resistencia 1500W 230V espirales 1 pos. de montaje arriba L 142mm An 158mm L1 95mm ø 49mm rosca M14x1,5 distancia de sujeción 150mm longitud del cable 970mm tubo ø 8.5mm resistencia seca sujeción 2 orificios			

1 				
código	415526	referencia	RESI0066	
descripción	resistencia 1500W 380V L 720mm An 260mm rosca M14x1,5 distancia de sujeción 290mm empalme cable tubo ø 8.5mm longitud del cable 1000mm espirales 1 resistencia seca sujeción 2 orificios			

1 				
código	418118	referencia	RESI0058	
descripción	resistencia 1800W 230V espirales 1 pos. de montaje abajo L 150mm An 155mm ø 55mm rosca M14x1,5 distancia de sujeción 150mm longitud del cable 945mm tubo ø 8.5mm empalme cable resistencia seca sujeción 2 orificios horno de pizza			
accesorios para	418118			
	código	510417	referencia	—
	junta plana fibra ø ext. 20mm int.ø 14mm espesor 2mm UE 1 pzs			
	código	520228	referencia	—
	arandela dentada int.ø 15.3mm ø ext. 24mm acero UE 1 pzs para rosca M14			
	código	520230	referencia	—
	tuerca rosca M14x1,5 H 5mm EC 19 acero zincado UE 1 pzs			
	código	521101	referencia	—
	tuerca rosca M14x1,5 H 5mm EC 19 inox UE 1 pzs			
	código	550262	referencia	—
	junta plana cobre ø ext. 20mm int.ø 14mm espesor 2mm			

1 				
código	415528	referencia	N/A	
descripción	resistencia 2000W 230V L 465mm An 450mm rosca M14x1,5 distancia de sujeción 441mm longitud de empalme 36mm tubo ø 8.5mm longitud del cable 430mm espirales 1 resistencia seca sujeción 2 orificios			
repuestos para	415528			
	código	510417	referencia	—
	junta plana fibra ø ext. 20mm int.ø 14mm espesor 2mm UE 1 pzs			
accesorios para	415528			
	código	361182	referencia	—
	tuerca rosca 1/4" H 5mm latón niquelado EC 17 UE 1 pzs			
	código	520228	referencia	—
	arandela dentada int.ø 15.3mm ø ext. 24mm acero UE 1 pzs para rosca M14			
	código	550262	referencia	—
	junta plana cobre ø ext. 20mm int.ø 14mm espesor 2mm			







código	418120	referencia	RESI0080
descripción	resistencia 2200W 230V espirales 1 pos. de montaje abajo L 150mm An 155mm L1 95mm ø 49mm rosca M14x1,5 distancia de sujeción 146mm longitud del cable 950mm tubo ø 8.5mm empalme cable resistencia seca sujeción 2 orificios		



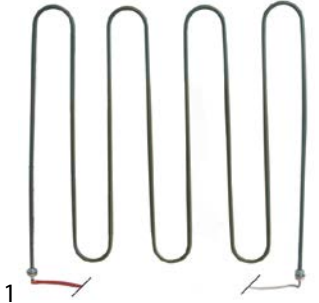

código	418121	referencia	RESI0060
descripción	resistencia 2200W 230V espirales 1 pos. de montaje arriba L 230mm An 262mm L1 170mm ø 60mm rosca M14x1,5 distancia de sujeción 254mm longitud del cable 1120mm tubo ø 8.5mm empalme cable resistencia seca sujeción 2 orificios		
Para modelos:	SYNTHESIS 08/50		

accesorios para	418121		
	código	510417	referencia —
		junta plana fibra ø ext. 20mm int.ø 14mm espesor 2mm UE 1 pzs	
	código	520228	referencia —
		arandela dentada int.ø 15.3mm ø ext. 24mm acero UE 1 pzs para rosca M14	
	código	520230	referencia —
		tuerca rosca M14x1,5 H 5mm EC 19 acero zincado UE 1 pzs	
	código	521101	referencia —
		tuerca rosca M14x1,5 H 5mm EC 19 inox UE 1 pzs	
	código	550262	referencia —
		junta plana cobre ø ext. 20mm int.ø 14mm espesor 2mm	



código	416432	referencia	N/A
descripción	resistencia 2500W 230V L 575mm An 570mm rosca M14x1,5 distancia de sujeción 561mm longitud de empalme 37mm tubo ø 8.7mm longitud del cable 570mm espirales 1 resistencia seca sujeción 2 orificios		
accesorios para	416432		
	código	510417	referencia —
		junta plana fibra ø ext. 20mm int.ø 14mm espesor 2mm UE 1 pzs	
	código	520228	referencia —
		arandela dentada int.ø 15.3mm ø ext. 24mm acero UE 1 pzs para rosca M14	
	código	520230	referencia —
		tuerca rosca M14x1,5 H 5mm EC 19 acero zincado UE 1 pzs	

accesorios para	416432		
	código	521101	referencia —
		tuerca rosca M14x1,5 H 5mm EC 19 inox UE 1 pzs	
	código	550262	referencia —
		junta plana cobre ø ext. 20mm int.ø 14mm espesor 2mm	







código	418123	referencia	RESI0081
descripción	resistencia 2800W 230V espirales 1 pos. de montaje arriba L 228mm An 260mm L1 168mm ø 60mm rosca M14x1,5 distancia de sujeción 251.5mm longitud del cable 1170mm tubo ø 8.5mm empalme cable resistencia seca sujeción 2 orificios		
Para modelos:	SYNTHESIS08-50V		



código	418125	referencia	RESI0041 RESI0125
descripción	resistencia 3000W 220V L 925mm An 70mm rosca M15x1 distancia de sujeción 61mm longitud de empalme 10mm tubo ø 10mm longitud del cable 480mm espirales 1 resistencia seca sujeción 2 orificios		
Para modelos:	SYNTHESIS 10/75		



código	418122	referencia	RESI0061
descripción	resistencia 3300W 230V espirales 1 pos. de montaje abajo L 230mm An 263mm L1 168mm ø 60mm rosca M14x1,5 distancia de sujeción 254.5mm longitud del cable 1140mm tubo ø 8.5mm empalme cable resistencia seca sujeción 2 orificios		
Para modelos:	SYNTHESIS 08/50		
repuestos para	418122		
	código	510417	referencia —
		junta plana fibra ø ext. 20mm int.ø 14mm espesor 2mm UE 1 pzs	
accesorios para	418122		
	código	520228	referencia —
		arandela dentada int.ø 15.3mm ø ext. 24mm acero UE 1 pzs para rosca M14	
	código	520230	referencia —
		tuerca rosca M14x1,5 H 5mm EC 19 acero zincado UE 1 pzs	
	código	521101	referencia —
		tuerca rosca M14x1,5 H 5mm EC 19 inox UE 1 pzs	
	código	550262	referencia —
		junta plana cobre ø ext. 20mm int.ø 14mm espesor 2mm	



			
1			
código	418124	referencia	RESI0082
descripción	resistencia 4100W 230V espirales 1 pos. de montaje abajo L 230mm An 248.5mm L1 175mm ø 65mm rosca M14x1,5 distancia de sujeción 240mm longitud del cable 1200mm tubo ø 8.5mm empalme cable resistencia seca sujeción 2 orificios		
Para modelos:	SYNTHESIS08-50V		

reguladores de energía

EGO

a 1 circuito

			
1			
código	380015	referencia	TERM0014 TERM0050
descripción	regulador de energía 230V 13A circuito simple sentido de rotación derecho eje ø 6x4,6mm eje L 23mm rosca de sujeción M4 liberación potencia 6-100% N° 50.57021.010		
Para modelos:	SYNTHESIS 08/50, SYNTHESIS 10/75, SYNTHESIS08-50V		

termostatos

termostatos de control y seguridad

EGO

termostatos de regulación

serie 55.10/19_

			
1			
código	375002	referencia	ELET0013
descripción	termóstato T máx 320°C margen de trabajo 55-320°C 1 polos 1NO 16A sonda ø 3.1mm sonda L 226mm capilar 870mm aislamiento del capilar 850mm prensaestopas eje L 23mm posición del eje arriba ángulo de rotación 270°		
Para modelos:	SYNTHESIS 05/40 A		

			
1			
código	375499	referencia	TERM0013 TERM0059
descripción	termóstato T máx 320°C margen de trabajo 60-320°C 1 polos 1NO 16A sonda ø 3.1mm sonda L 226mm capilar 870mm aislamiento del capilar 870mm prensaestopas eje ø 6x4,6mm eje L 23mm posición del eje arriba ángulo de rotación 270°		

			
1			
código	375884	referencia	TERMO0072
descripción	termóstato T máx 400°C margen de trabajo 65-400°C 1 polos 1NO sonda ø 3.9mm sonda L 163mm capilar 870mm aislamiento del capilar 600mm prensaestopas eje ø 6x4,6mm eje L 23mm posición del eje arriba ángulo de rotación 270°		
accesorios para	375884		
	código	112172	referencia —
	pomo universal ø 70mm negro sin adaptador/símbolo		
	código	112311	referencia —
	adaptador de pomo eje ø 6x4,6mm L 0mm con muelle		
	código	112405	referencia —
	símbolo para pomo plata termóstato T máx 350°C 100-350°C ángulo de rotación 270° ø ext. 63mm int. ø 45.5mm		



termostatos de seguridad

serie 55.32_

código	375065	referencia	TERM0005
descripción	termostato de seguridad temp. desconexión 500°C 3 polos 3NC 20A sonda ø 4mm sonda L 308mm capilar 890mm aislamiento del capilarmm prensaestopas bulbo inox		
Para modelos:	CITIZEN 6, CITIZEN 9, SYNTHESIS 05/40 A, SYNTHESIS 08/50, SYNTHESIS 08/50 A, SYNTHESIS 10/75, SYNTHESIS 10/75 A, SYNTHESIS 10/75 B22, SYNTHESIS08-50V, T2 POLIS MC16, T2 POLIS MC26, T3 POLIS MC16, T3 POLIS MC26, T4 POLIS MC16, T4 POLIS MC26, T6 POLIS MC16, T6 POLIS MC26		

código	301003	referencia	INTE0010	
descripción	interruptor basculante medida de montaje 30x22mm verde 2NO 250V 16A iluminado 0-I empalme conector Faston 6,3mm temperatura ambiente máx. 125/55°C protección IP65			
Para modelos:	CITIZEN 6, CITIZEN 9, SYNTHESIS 05/40 A, SYNTHESIS 10/75, SYNTHESIS08-50V			
accesorios para	301003			
	código	301036	referencia	—
	cubierta protectora dimensión interior 30x22mm para interruptor basculante medida de montaje mm			

código	301020	referencia	INTE0012
descripción	pulsador basculante medida de montaje 30x22mm rojo 2NO 250V 16A iluminado 0-I empalme conector Faston 6,3mm temperatura ambiente máx. 100/55°C protección IP65		
Para modelos:	CITIZEN 6, CITIZEN 9, SYNTHESIS 05/40 A		

interruptores y pulsadores

interruptores/pulsadores basculantes

30x22mm

código	301002	referencia	INTE0009	
descripción	interruptor basculante medida de montaje 30x22mm naranja 2NO 250V 16A iluminado 0-I empalme conector Faston 6,3mm temperatura ambiente máx. 85/125°C protección IP65			
Para modelos:	CITIZEN 6, CITIZEN 9, SYNTHESIS 05/40 A, SYNTHESIS 08/50, SYNTHESIS 10/75, SYNTHESIS08-50V			
accesorios para	301002			
	código	301036	referencia	—
	cubierta protectora dimensión interior 30x22mm para interruptor basculante medida de montaje mm			

código	346361	referencia	INTE0011	
descripción	interruptor basculante medida de montaje 30x22mm blanco 2CO 250V 16A I-II empalme conector Faston 6,3mm temperatura ambiente máx. 85°C protección IP40			
Para modelos:	CITIZEN 6, CITIZEN 9, SYNTHESIS 05/40 A			
accesorios para	346361			
	código	301036	referencia	—
	cubierta protectora dimensión interior 30x22mm para interruptor basculante medida de montaje mm			

código	301001	referencia	INTE0004	
descripción	interruptor basculante medida de montaje 30x22mm rojo 2NO 250V 16A iluminado 0-I empalme conector Faston 6,3mm temperatura ambiente máx. 125/55°C protección IP65			
Para modelos:	SYNTHESIS 05/40 A, SYNTHESIS 08/50, SYNTHESIS 10/75, SYNTHESIS08-50V			
accesorios para	301001			
	código	301036	referencia	—
	cubierta protectora dimensión interior 30x22mm para interruptor basculante medida de montaje mm			

conmutadores giratorios

BREMAS

serie CR025

código	347832	referencia	INTE0001
descripción	conmutador giratorio 3 0-1-2 juegos de contactos 8 tipo CR0250010 690V 32A eje ø 5x5mm eje L 17mm eje cuadrado empalme atornillado		

BRETER

conmutadores giratorios



1

código	346546	referencia	INTE001
descripción	conmutador giratorio Y-0-D 25A 3-posiciones de conmutación 3 polos		

codificadores y potenciómetros



1

código	300189	referencia	ELET0200
descripción	potenciómetro		
Para modelos:	SYNTHESIS 05/40 A, SYNTHESIS 08/50, SYNTHESIS 10/75, SYNTHESIS08-50V		

lámparas

lámparas de señalización

lámparas de señalización completas

ø10mm

con casquillo roscado



1

código	359791	referencia	LAMP0007
descripción	lámpara de señalización ø 10mm 230V verde longitud del cable 250mm		
Para modelos:	SYNTHESIS 05/40 A		

30x22mm



1

código	359156	referencia	LAMP0002
descripción	lámpara de señalización medida de montaje 30x22mm 230V amarillo empalme conector Faston 6,3mm resis.a la temp. 125/55°C tipo RL2		



1

código	359180	referencia	LAMP0002	
descripción	lámpara de señalización medida de montaje 30x22mm 230V amarillo empalme conector Faston 6,3mm tipo Marquardt 1667..			
Para modelos:	CITIZEN 6, CITIZEN 9, SYNTHESIS 08/50, SYNTHESIS 10/75, SYNTHESIS08-50V			
accesorios para	359180			
	código	301036	referencia	—
	cubierta protectora dimensión interior 30x22mm para interruptor basculante medida de montaje			



1

código	359157	referencia	LAMP0006	
descripción	lámpara de señalización medida de montaje 30x22mm 230V verde empalme conector Faston 6,3mm resis.a la temp. 125/55°C tipo RL2			
accesorios para	359157			
	código	301036	referencia	—
	cubierta protectora dimensión interior 30x22mm para interruptor basculante medida de montaje			



1

código	359178	referencia	LAMP0006	
descripción	lámpara de señalización medida de montaje 30x22mm 230V verde empalme conector Faston 6,3mm resis.a la temp. 85°C tipo Marquardt 1667.. IP44			
Para modelos:	CITIZEN 6, CITIZEN 9, SYNTHESIS 05/40 A, SYNTHESIS 08/50, SYNTHESIS 10/75, SYNTHESIS08-50V			
accesorios para	359178			
	código	301036	referencia	—
	cubierta protectora dimensión interior 30x22mm para interruptor basculante medida de montaje			

lámpade

bombillas incandescentes

para hornos



1

código	359614	referencia	LAMP0003
descripción	bombilla incandescente T máx 300°C casquillo E27 230V 40W ø 45mm L 71mm cristal L 44mm UE 1 pzs		
Para modelos:	CITIZEN 6, CITIZEN 9		

lámparas halógenas

para portalámpara G4 / G6,35 / G9



1 **500°C**

código	359074	referencia	LAMP0045
descripción	lámpara halógena casquillo G6,35 12V 35W resis.a la temp. 500°C		

para portalámpara GU5,3 / GU10 / GZ5,3



1

código	359665	referencia	ELET0226 LAMP0037
descripción	lámpara halógena casquillo GU10 230V 50W resis.a la temp.°C		
Para modelos:	T2 POLIS MC16, T2 POLIS MC26, T3 POLIS MC16, T3 POLIS MC26, T4 POLIS MC16, T4 POLIS MC26, T6 POLIS MC16, T6 POLIS MC26		

lámparas para hornos

lámparas de horno específicas del fabricante

ZANOLLI



1

código	359666	referencia	ELET0227 LAMP0008
descripción	portalámparas 250V casquillo E27 empalme atornillado ø 40mm H 46mm con escuadra de sujeción distancia de sujeciónmm longitud del soporte 46mm UE 1 pzs		
Para modelos:	CITIZEN 6, CITIZEN 9		



1

código	693380	referencia	CRIS0023
descripción	vidrio L 100mm An 100mm cuadrado espesor 6mm		
Para modelos:	CITIZEN 6, CITIZEN 9		



1

código	359664	referencia	LAMP0021
descripción	portalámparas An 21mm 24V casquillo GU10 empalme borne d empalme ø 17mm H 12mm con sujeción de 2 orificios distancia de sujeción 11.5mm UE 1 pzs		
Para modelos:	T2 POLIS MC16, T2 POLIS MC26, T3 POLIS MC16, T3 POLIS MC26, T4 POLIS MC16, T4 POLIS MC26, T6 POLIS MC16, T6 POLIS MC26		

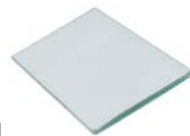

1

código	693379	referencia	CRIS0006
descripción	vidrio L 180mm An 90mm rectangular espesor 6mm		
Para modelos:	T2 POLIS MC16, T2 POLIS MC26, T3 POLIS MC16, T3 POLIS MC26, T4 POLIS MC16, T4 POLIS MC26, T6 POLIS MC16, T6 POLIS MC26		



1

código	359665	referencia	ELET0226 LAMP0037
descripción	lámpara halógena casquillo GU10 230V 50W resis.a la temp.°C		
Para modelos:	T2 POLIS MC16, T2 POLIS MC26, T3 POLIS MC16, T3 POLIS MC26, T4 POLIS MC16, T4 POLIS MC26, T6 POLIS MC16, T6 POLIS MC26		

lámparas

bombillas incandescentes



1

código	359614	referencia	LAMP0003
descripción	bombilla incandescente T máx 300°C casquillo E27 230V 40W ø 45mm L 71mm cristal L 44mm UE 1 pzs		
Para modelos:	CITIZEN 6, CITIZEN 9		

lámparas halógenas

para portalámpara G4 / G6,35 / G9



1 **500°C**

código	359074	referencia	LAMP0045
descripción	lámpara halógena casquillo G6,35 12V 35W resis.a la temp. 500°C		



para portalámparas GU5,3 / GU10



1

código	359665	referencia	ELET0226 LAMP0037
descripción	lámpara halógena casquillo GU10 230V 50W resis.a la temp.°C		
Para modelos:	T2 POLIS MC16, T2 POLIS MC26, T3 POLIS MC16, T3 POLIS MC26, T4 POLIS MC16, T4 POLIS MC26, T6 POLIS MC16, T6 POLIS MC26		

contactores

GENERAL ELECTRIC (AEG)

contactores de potencia



1

código	380261	referencia	ELET0002
descripción	contactor de potencia AC1 32A 230VAC (AC3/400V) 17A/7,5kW contactos principales 3NO contactos auxiliares 1NO empalme empalme atornillado tipo AEG LS7K 10A tipo GE CL02A 310		
Para modelos:	SYNTHESIS 05/40 A, SYNTHESIS 08/50, SYNTHESIS 08/50 A, SYNTHESIS 10/75, SYNTHESIS 10/75 A, SYNTHESIS 10/75 B22, SYNTHESIS08-50V, T2 POLIS MC16, T2 POLIS MC26, T3 POLIS MC16, T3 POLIS MC26, T4 POLIS MC16, T4 POLIS MC26, T6 POLIS MC16, T6 POLIS MC26		

LOVATO

contactores de potencia



1

código	380788	referencia	ELET0432
descripción	contactor de potencia AC1 32A 230VAC (AC3/400V) 18A/7,5kW contactos principales 4NO empalme empalme atornillado tipo BF18T4A230		

ALLEN BRADLEY

contactores de potencia



1

código	380469	referencia	ELET0160
descripción	contactor de potencia AC1 32A 230VAC (AC3/400V) 9A/4kW contactos principales 4NO empalme empalme atornillado tipo 100-C09KF400		

transformadores

transformadores abiertos

con borne de empalme



1

código	401199	referencia	ELET0003 (old version)
descripción	transformador 63VA		



1

código	401198	referencia	ELET0094
descripción	transformador primaria 0/230/400V secundaria 12/0/12V 160VA		
Para modelos:	CITIZEN 6, CITIZEN 9, SYNTHESIS 05/40 A, SYNTHESIS 08/50, SYNTHESIS08-50V		



1

código	403573	referencia	ELET0003
descripción	transformador primaria 230/400VAC secundaria 115VAC 63VA secundaria 0.5A H 78mm L 85mm An 77mm empalme atornillado 50/60Hz tipo SFM00063CC15 abierto		
Para modelos:	SYNTHESIS 05/40 A, SYNTHESIS 08/50 A, SYNTHESIS 10/75 A, SYNTHESIS 10/75 B22		



controladores electrónicos

ELIWELL

controladores universales

versión empotrada



1

código	378202	referencia	TERM0011
descripción	controlador electrónico ELIWELL tipo EW7210 modelo E7211A-0XHD700 medida de montaje 66,5x66,5mm aliment. 95-240V tensión AC TC (J,K) salidas de relé 1 CO-8A(3) TC (J,K) profundidad de montaje 80mm protección IP55 versión empotrada func. descon. no -40 a 1600°C display 2x 4 dígitos		
accesorios para	378202		
	código	378074	referencia —
		sensor de temperatura termopar J (Fe-CuNi) cable Vetrotex sonda -50 a +750°C cable -50 a +350°C bulbo ø3x100mm longitud de cable 3m sin racor de dos hilos	
	código	378075	referencia —
		sensor de temperatura termopar K (NiCr-Ni) cable Vetrotex sonda -50 a 1150°C cable -50 a +350°C bulbo ø4,5x150mm longitud de cable 3m sin racor de dos hilos	
	código	379051	referencia TERM0017
		sensor de temperatura termopar J (Fe-CuNi) cable Vetrotex sonda -50 a +750°C cable -50 a +350°C bulbo ø6x100mm longitud de cable 3m sin racor colores cable rojo/azul de dos hilos	
	código	379062	referencia —
		sensor de temperatura termopar J (Fe-CuNi) cable Vetrotex sonda -50 a +750°C cable -50 a +350°C bulbo ø6x50mm longitud de cable 3m sin racor de dos hilos	



1

código	379568	referencia	TERM0012
descripción	controlador electrónico ELIWELL tipo ICPlus915 modelo ICP-22JI750000 medida de montaje 71x29mm aliment. 230V tensión AC Pt100/TC (J,K) salidas de relé 2 CO-8A(4) CO-8A(4) Pt100/TC (J,K,S) DI dimensiones frontales 78x37mm profundidad de montaje 60mm modo operativo aparatos térmicos protección IPx0 precisión 1% versión empotrada func. descon. no -150 a 1350°C display 3½ dígitos		
Para modelos:	CITIZEN 6, CITIZEN 9, SYNTHESIS 08/50, SYNTHESIS 10/75, SYNTHESIS08-50V		
accesorios para	379568		
	código	378065	referencia —
		equipo de alarma AKO tipo AKO-520641 medida de montaje 214x214mm aliment. 230V tensión AC salidas de relé 1 CO-8A(4) hasta 4 dimensiones frontales 222x222mm presente presente	
	código	378074	referencia —
		sensor de temperatura termopar J (Fe-CuNi) cable Vetrotex sonda -50 a +750°C cable -50 a +350°C bulbo ø3x100mm longitud de cable 3m sin racor de dos hilos	

accesorios para	379568		
	código	378075	referencia —
		sensor de temperatura termopar K (NiCr-Ni) cable Vetrotex sonda -50 a 1150°C cable -50 a +350°C bulbo ø4,5x150mm longitud de cable 3m sin racor de dos hilos	
	código	379050	referencia —
		sensor de temperatura Pt100 cable Vetrotex sonda -200 a +600°C cable -50 a +350°C bulbo ø6x100mm longitud de cable 2.7m sin racor de tres hilos	
	código	379062	referencia —
		sensor de temperatura termopar J (Fe-CuNi) cable Vetrotex sonda -50 a +750°C cable -50 a +350°C bulbo ø6x50mm longitud de cable 3m sin racor de dos hilos	

termómetros electrónicos



1

código	378198	referencia	TERM0009
descripción	termómetro ELIWELL tipo EM300LX medida de montaje 71x29mm 12V tensión AC/DC -200 a 800°C Pt100/TC (J,K) display 3½ dígitos dimensiones frontales 35x76mm precisión 1%		
accesorios para	378198		
	código	378075	referencia —
		sensor de temperatura termopar K (NiCr-Ni) cable Vetrotex sonda -50 a 1150°C cable -50 a +350°C bulbo ø4,5x150mm longitud de cable 3m sin racor de dos hilos	
	código	379050	referencia —
		sensor de temperatura Pt100 cable Vetrotex sonda -200 a +600°C cable -50 a +350°C bulbo ø6x100mm longitud de cable 2.7m sin racor de tres hilos	
	código	379051	referencia TERM0017
		sensor de temperatura termopar J (Fe-CuNi) cable Vetrotex sonda -50 a +750°C cable -50 a +350°C bulbo ø6x100mm longitud de cable 3m sin racor colores cable rojo/azul de dos hilos	
	código	379054	referencia —
		transformador primaria 230VAC secundaria 12VAC 3VA secundaria 0.25A H 40mm L 45mm An 50mm empalme atornillado 50/60Hz tipo 153/M	
	código	379063	referencia —
		sensor de temperatura termopar J (Fe-CuNi) cable Vetrotex sonda -50 a +750°C cable -50 a +350°C bulbo ø6x50mm longitud de cable 1.9m sin racor de dos hilos	

EVCO - EVERY CONTROL

controladores universales

versión empotrada



código	378134	referencia	TERM0060
descripción	controlador electrónico EVERY CONTROL EVK411 medida de montaje 71x29mm profundidad de montaje 59mm aliment. 230V tensión AC NTC/PTC/Pt100/Pt1000/TC(J,K)/mV/mA salidas de relé 1 CO-16A(8) NTC/PTC/Pt100/Pt1000/TC(J,K)/mV/mA presente protección IP55 dependiente de sensor°C display 3½ dígitos		
accesorios para	378134		
	código	378075	referencia —
	sensor de temperatura termopar K (NiCr-Ni) cable Vetrotex sonda -50 a 1150°C cable -50 a +350°C bulbo ø4,5x150mm longitud de cable 3m sin racor de dos hilos		
	código	379051	referencia TERM0017
	sensor de temperatura termopar J (Fe-CuNi) cable Vetrotex sonda -50 a +750°C cable -50 a +350°C bulbo ø6x100mm longitud de cable 3m sin racor colores cable rojo/azul de dos hilos		
	código	379062	referencia —
	sensor de temperatura termopar J (Fe-CuNi) cable Vetrotex sonda -50 a +750°C cable -50 a +350°C bulbo ø6x50mm longitud de cable 3m sin racor de dos hilos		

código	379941	referencia	TERM0020 TERM0084
descripción	sensor de temperatura termopar J (Fe-CuNi) cable Vetrotex sonda -50 a +750°C cable -50 a +350°C empalme de dos hilos rosca bulbo ø6x200mm longitud de cable 1m		
Para modelos:	CITIZEN 6, CITIZEN 9, SYNTHESIS 08/50, SYNTHESIS 10/75, SYNTHESIS08-50V, T2 POLIS MC16, T2 POLIS MC26, T3 POLIS MC16, T3 POLIS MC26, T4 POLIS MC16, T4 POLIS MC26, T6 POLIS MC16, T6 POLIS MC26		

código	379942	referencia	TERM0018
descripción	sensor de temperatura termopar J cable Vetrotex sonda -50 a +750°C cable -50 a +350°C empalme de dos hilos rosca bulbo ø6x200mm longitud de cable 1.5m		
Para modelos:	SYNTHESIS 10/75		

electrónicas

placas electrónicas

código	401201	referencia	ELET0148
descripción	placa base		
Para modelos:	T2 POLIS MC16, T2 POLIS MC26, T3 POLIS MC16, T3 POLIS MC26, T4 POLIS MC16, T4 POLIS MC26, T6 POLIS MC16, T6 POLIS MC26		

código	401205	referencia	ELET0212
descripción	placa base		
Para modelos:	SYNTHESIS 05/40 A, SYNTHESIS 08/50 A, SYNTHESIS 10/75 A, SYNTHESIS 10/75 B22, SYNTHESIS08-50V		

sensores

sensores universales

sondas de temperatura

código	379051	referencia	TERM0017
descripción	sensor de temperatura termopar J (Fe-CuNi) cable Vetrotex sonda -50 a +750°C cable -50 a +350°C bulbo ø6x100mm longitud de cable 3m sin racor colores cable rojo/azul de dos hilos		
accesorios para	379051		
	código	379877	referencia —
	controlador electrónico HONEYWELL tipo DC10N-400 medida de montaje 92x92mm aliment. 24/230V tensión AC TC (J) salidas de relé 1 CO-10A(6) TC (J) universal profundidad de montaje 55mm protección IP54 precisión 1% versión empotrada func. descon. no 0 a +400°C display 3 dígitos		

sensores específicos del fabricante

sensores

código	379944	referencia	TERM0019 TERM0022 TERM0049
descripción	sensor de temperatura Pt1000 cable Vetrotex sonda -70 a +500°C cable -50 a +350°C empalme de dos hilos rosca bulbo ø6x180mm longitud de cable 1.7m		
Para modelos:	SYNTHESIS 05/40 A, SYNTHESIS 08/50, SYNTHESIS 08/50 A, SYNTHESIS 10/75, SYNTHESIS 10/75 A, SYNTHESIS 10/75 B22, SYNTHESIS08-50V		



1

código	401204	referencia	ELET0155
descripción	placa de display		
Para modelos:	SYNTHESIS 05/40 A, SYNTHESIS 08/50, SYNTHESIS 08/50 A, SYNTHESIS 10/75, SYNTHESIS 10/75 A, SYNTHESIS 10/75 B22, SYNTHESIS08-50V		



1

código	401200	referencia	ELET0149
descripción	placa de teclado		
Para modelos:	T2 POLIS MC16, T2 POLIS MC26, T3 POLIS MC16, T3 POLIS MC26, T4 POLIS MC16, T4 POLIS MC26, T6 POLIS MC16, T6 POLIS MC26		



1

código	401206	referencia	ELET0203
descripción	placa electrónica control de motor		
Para modelos:	SYNTHESIS 05/40 A, SYNTHESIS 08/50, SYNTHESIS 10/75, SYNTHESIS08-50V		



1

código	401207	referencia	ELET0213
descripción	placa electrónica control de motor		
Para modelos:	SYNTHESIS 05/40 A, SYNTHESIS 08/50, SYNTHESIS 08/50 A, SYNTHESIS 10/75, SYNTHESIS 10/75 A, SYNTHESIS 10/75 B22, SYNTHESIS08-50V		

teclados

membranas de teclado



1

código	504381	referencia	PANN0275
descripción	membrana de teclado para horno de pizza negro apto para ZANOLLI L 325mm An 130mm tazas 11		

teclados de membrana



1

código	401202	referencia	ELET0165
descripción	teclado de membrana 6 teclas		
Para modelos:	SYNTHESIS 08/50, SYNTHESIS 10/75, SYNTHESIS08-50V		



1

código	401203	referencia	ELET0153
descripción	teclado de membrana 6 teclas		
Para modelos:	SYNTHESIS 05/40 A, SYNTHESIS 08/50 A, SYNTHESIS 10/75 A, SYNTHESIS 10/75 B22		



presostatos

para aparatos de café



otros



código	541477	referencia	ELET0548
descripción	presostato margen de presión 0.6bar empalme 1/4" 16A 1 polos tipo aparatos de café		

para sistemas de gas



código	542115	referencia	ELET0641
descripción	presostato ø 65mm margen de presión 0,17-0,75mbar empalme 6,8mm empalme presión ø 6.8mm		
accesorios para	542115		
	código	542366	referencia SUPP0413
		soporte para presóstatos	
	código	542367	referencia SUPP0414
		soporte para presóstatos	
	código	560521	referencia —
		tornillo de chapa ø 4mm L 10mm inox UE 1 pzs 14585 soporte Phillips ø cabezal 8mm	

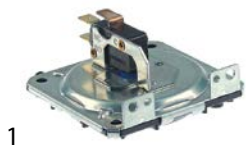

código	541348	referencia	ELET0130
descripción	presostato sistemas de gas empalme conector Faston 6,3mm apto para ZANOLLI		
Para modelos:	SYNTHESIS 05/40 A, SYNTHESIS 08/50 A, SYNTHESIS 10/75 A, SYNTHESIS 10/75 B22		

accesorios



código	542366	referencia	SUPP0413
descripción	soporte para presóstatos		



código	542367	referencia	SUPP0414
descripción	soporte para presóstatos		
accesorios para	542367		
	código	542115	referencia ELET0641
		presostato ø 65mm margen de presión 0,17-0,75mbar empalme 6,8mm empalme presión ø 6.8mm	

ventiladores

ventilador axial

importación



código	601080 ¹	referencia	VENT0012
descripción	ventilador axial L 119mm An 119mm H 38mm 230VAC 50/60Hz 23/20W cojinete rodamiento de bolas empalme conector Faston 2,8mm metal ADDA rodete ventilador ø 110mm resis.a la temp. 70°C		
Para modelos:	SYNTHESIS 08/50, SYNTHESIS 10/75, SYNTHESIS08-50V		
accesorios para	601080		
	código	550898	referencia —
		cable de conexión longitud del cable 2000mm empalme F 2,8 distancia de empalme 7.9mm para ventilador axial	
	código	692519	referencia —
		rejilla de protección L 120mm An 120mm plástico	

¹con rodamiento de bolas



código	601130 ¹	referencia	VENT0024
descripción	ventilador axial L 80mm An 80mm H 25mm 230VAC 50/60Hz 13/14W cojinete rodamiento de bolas empalme conector Faston 2,8mm metal ADDA rodete ventilador ø 75mm resis.a la temp. 70°C caudal 30.6m³/h		
accesorios para	601130		
	código	550898	referencia —
		cable de conexión longitud del cable 2000mm empalme F 2,8 distancia de empalme 7.9mm para ventilador axial	

¹con rodamiento de bolas

motores de aire caliente

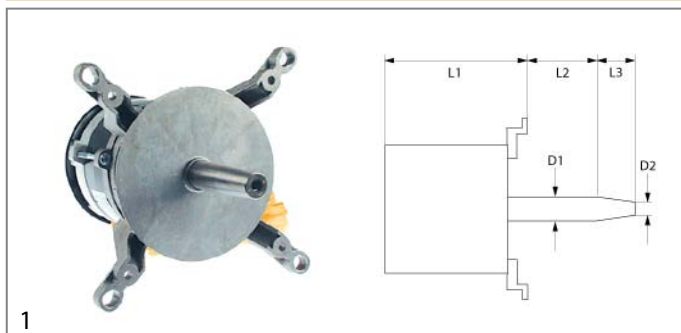

código	500681	referencia	MOTO0030
descripción	motor de ventilador 220-240V fases 1 50Hz 0.37kW 1400rev/min velocidades 1 L1 265mm L2 45mm L3 47mm D1 ø 24mm D2 ø 20mm M8I F 2A condensador apropiado 12,5µF/400V a 50 Hz 1400rev/min tipo 1021S2252		
Para modelos:	SYNTHESIS 08/50, SYNTHESIS 10/75, SYNTHESIS08-50V		
repuestos para	500681		
	código	521078	referencia VENT0022
			rodete ventilador
	código	601217	referencia VENT0015
			rodete ventilador D1 ø 335mm H1 100mm palas 24 D2 ø 19.5mm D3 ø 23mm H2 45mm
accesorios para	500681		
	código	365014	referencia —
			condensador de servicio capacidad 12.5µF 450V tolerancia 5%Hz temperatura ambiente máx. -25 a + 85°C ø 35mm L 70mm M8 plástico empalme conector Faston 6,3mm 45S.C3DS.12,5 protección

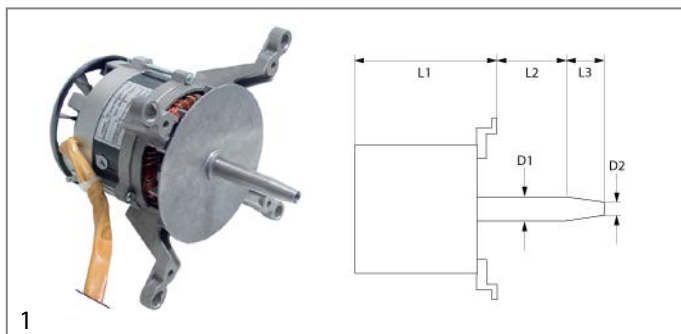

código	500664	referencia	MOTO0034
descripción	motor de ventilador 230V fases 1 50Hz 0.37kW 1400rev/min velocidades 1 L1 170mm L2 50mm L3 28mm D1 ø 17mm D2 ø 12mm M8I F 2.2A condensador apropiado 10µF/450V Cos(fi) 0.95 a 50 Hz 1400rev/min tipo 1020A2353		

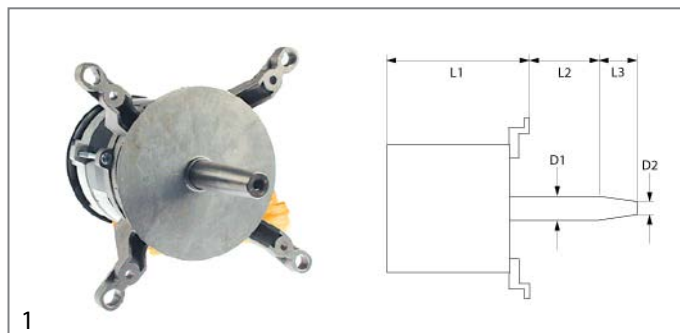

código	500651	referencia	MOTO0030
descripción	motor de ventilador 230V fases 1 50Hz 0.75PS 1400rev/min velocidades 1 3.6A condensador apropiado 16µF/450V		



código	601215	referencia	VENT0001
descripción	rodete ventilador D1 ø 250mm H1 78mm palas 20 D2 ø 11.5mm D3 ø 16mm H2 30mm		
Para modelos:	SYNTHESIS 05/40 A		



código	601216	referencia	VENT0018
descripción	rodete ventilador D1 ø 300mm H1 100mm palas 20 D2 ø 19.5mm D3 ø 23mm H2 45mm		

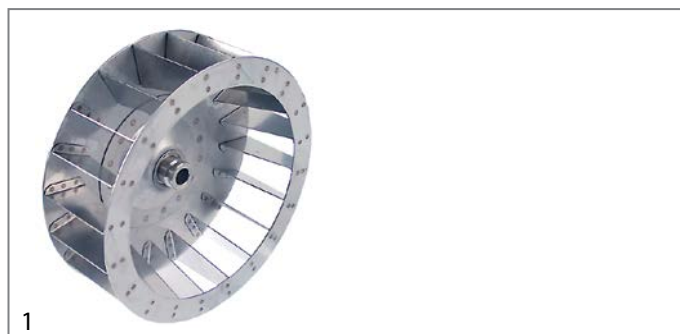

código	601241	referencia	VENT0018
descripción	rodete ventilador D1 ø 300mm H1 100mm palas 20 D2 ø 19.5mm D3 ø 23mm H2 46mm		
Para modelos:	SYNTHESIS 08/50, SYNTHESIS 08/50 A, SYNTHESIS08-50V		



1

código	601217	referencia	VENT0015
descripción	rodete ventilador D1 ø 335mm H1 100mm palas 24 D2 ø 19.5mm D3 ø 23mm H2 45mm		
Para modelos:	SYNTHESIS 10/75, SYNTHESIS 10/75 B22, SYNTHESIS 10/75A		



1

código	550848	referencia	ELET0440
descripción	portafusibles fusible adaptable ø5x20mm		

motores

motorreductores

para hornos

por cinta transportadora



1

código	500809	referencia	MOTO0052
descripción	motorreductor TRANSTECNO tipo MCB34480190G8 70W 48V 7.46rev/min árbol ø 12mm L 220mm An 95mm H 175mm para banda transportadora		
Para modelos:	SYNTHESIS 05/40 A, SYNTHESIS 08/50, SYNTHESIS 10/75, SYNTHESIS08-50V		

accesorios eléctricos

terminales

bloques de bornes

WIELAND

bloques de bornes tipo 9700A



1

código	550378	referencia	ELET0053
descripción	borne seccionable WIELAND tipo 9700A/16 SL2 S35 2,5-35mm ² riel de sombrero 35mm amarillo/verde An 16mm L 53mm		

fusibles

fusibles finos

portafusibles



1

código	550691	referencia	ELET0058
descripción	portafusibles		
Para modelos:	CITIZEN 6, CITIZEN 9, SYNTHESIS 08/50, SYNTHESIS 10/75, SYNTHESIS08-50V		

válvulas de gas y centralitas de gas automáticas



válvulas de control de gas

SIT

TANDEM







1

código	101984	referencia	GASI0007
descripción	válvula de gas aliment. 230V 50Hz entrada gas 1/2" salida gas 1/2" conexión de piloto nivel encendido lento tiempo de encendidos margen de presión 2-50mbar alim. para modulador 230VAC rectificado Tandem núm. Ref. 0.836.010		
Para modelos:	CITIZEN 6, CITIZEN 9, SYNTHESIS 05/40 A, SYNTHESIS 08/50 A, SYNTHESIS 10/75 A, SYNTHESIS 10/75 B22		
repuestos para	101984		
	código	101379	referencia —
	bobina magnética aliment. 230V 50Hz apto para Tandem		
accesorios para	101984		
	código	101274	referencia —
	anillo cortante para tubo ø 16mm UE 1 pzs		

Continúa en la página siguiente



accesorios para	101984		
	código	101275	referencia —
tornillo de racor rosca 1/2" para tuboø 16mm UE 1 pzs			
	código	101925	referencia —
tapón con junta tórica rosca M10x1 para quemador piloto apto para NOVASIT			
	código	102845	referencia —
empalme de gas acodado 1/2" brida 32x32mm dist. del agujero 24x24mm Tandem			
	código	102846	referencia —
empalme de gas recto 1/2" brida 32x32mm dist. del agujero 24x24mm apto para Tandem			
	código	102847	referencia —
junta tórica			

centralitas de gas automáticas

BRAHMA

			
1			
código	102338	referencia	ELET0134
descripción	centralita de gas automática BRAHMA tipo SM11PMIX electrodos 2 tiempo de espera 1.5s tiempo de seguridad 5s 230V 7VA 50-60Hz		
Para modelos:	CITIZEN 6, CITIZEN 9, SYNTHESIS 05/40 A, SYNTHESIS 08/50 A, SYNTHESIS 10/75 A, SYNTHESIS 10/75 B2		

encendidos y tempares

electródos

			
1			
código	102339	referencia	AGAS0014
descripción	electrodo de encendido D1 ø 7mm D2 ø 8.5mm empalme M4 L1 125mm LC1 18mm LC2 3mm LC3 22mm para apretar		
Para modelos:	CITIZEN 6, CITIZEN 9, SYNTHESIS 05/40 A, SYNTHESIS 08/50 A, SYNTHESIS 10/75 A, SYNTHESIS 10/75 B2		

unidades de encendido

			
1			
código	101017	referencia	ELET0135
descripción	grupo de encendido salidas 2 230VAC medidas 85x70x35mm distancia de sujeción 60mm entrada cable salida ø4mm tipo TC2STCAF 55VA 50/60Hz		
Para modelos:	CITIZEN 6, CITIZEN 9, SYNTHESIS 05/40 A, SYNTHESIS 08/50 A, SYNTHESIS 10/75 A, SYNTHESIS 10/75 B2		

boquillas de gas

inyectores principales

boquillas de gas M 10x1

			
1			
código	106503	referencia	UGAS0039
descripción	boquilla de gas rosca M10x1 EC 11 taladro ø 1.1mm		



			
1			
código	107146	referencia	UGAS0007
descripción	boquilla de gas rosca M10x1 EC 11 taladro ø 3.85mm		

materiales auxiliares de gas

presostatos

			
1			
código	542115	referencia	ELET0641
descripción	presostato ø 65mm margen de presión 0,17-0,75mbar empalme 6,8mm empalme presión ø 6.8mm		
accesorios para	542115		
	código	542366	referencia SUPP0413
		soporte para presóstatos	
	código	542367	referencia SUPP0414
		soporte para presóstatos	
	código	560521	referencia —
		tornillo de chapa ø 4mm L 10mm inox UE 1 pzs 14585 soporte Phillips ø cabezal 8mm	

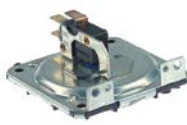
			
1			
código	541348	referencia	ELET0130
descripción	presostato sistemas de gas empalme conector Faston 6,3mm apto para ZANOLLI		
Para modelos:	SYNTHESIS 05/40 A, SYNTHESIS 08/50 A, SYNTHESIS 10/75 A, SYNTHESIS 10/75 B22		

componentes específicos

para horno con cinta transportadora

tapas

			
1			
código	693390	referencia	CUSC0012
descripción	tapa para árbol de accionamiento con orificio pos. de montaje derecho		

			
1			
código	693389	referencia	CUSC0013
descripción	tapa para árbol de accionamiento sin orificio pos. de montaje izquierdo		
Para modelos:	SYNTHESIS 05/40 A, SYNTHESIS 08/50 A, SYNTHESIS 10/75 A, SYNTHESIS 10/75 B22		

cintas transportadoras

			
1			
código	694278	referencia	RETE0013
descripción	cinta transportadora An 500mm para horno de pizza UE al metro		
Para modelos:	SYNTHESIS08-50V		

para hornos de pizza

árboles de accionamiento

			
1			
código	693382	referencia	MECC0125
descripción	árbol para horno de pizza L 595mm		
Para modelos:	SYNTHESIS 08/50, SYNTHESIS 08/50 A, SYNTHESIS08-50V		

			
1			
código	693383	referencia	MECC0155
descripción	árbol para horno de pizza L 856mm		
Para modelos:	SYNTHESIS 10/75, SYNTHESIS 10/75 A, SYNTHESIS 10/75 B22		

			
1			
código	693381	referencia	MECC0417
descripción	árbol de accionamiento para horno de pizza L 490mm		
Para modelos:	SYNTHESIS 05/40 A		

recambios y accesorios



1

código	693393	referencia	MECC0114
descripción	acoplamiento para horno de pizza para árbol de accionamiento		
Para modelos:	SYNTHESIS 05/40 A, SYNTHESIS 08/50, SYNTHESIS 08/50 A, SYNTHESIS 10/75, SYNTHESIS 10/75 A, SYNTHESIS 10/75 B22, SYNTHESIS08-50V		



1

código	693395	referencia	MECC0036
descripción	pieza distanciadora para árbol de accionamiento int.ø 20mm para horno de pizza ø 38mm H 20mm		
Para modelos:	SYNTHESIS 08/50, SYNTHESIS 08/50 A, SYNTHESIS 10/75, SYNTHESIS 10/75 A, SYNTHESIS 10/75 B22, SYNTHESIS08-50V		



1

código	693394	referencia	MECC0419
descripción	pieza distanciadora para árbol de accionamiento para horno de pizza		
Para modelos:	SYNTHESIS 05/40 A		

vidrios



1

código	693377	referencia	CRIS0026
descripción	vidrio L 325mm An 93mm espesor 6mm rectangular		
Para modelos:	CITIZEN 6, CITIZEN 9		



1

código	693378	referencia	CRIS0034
descripción	vidrio L 415mm An 105mm espesor 6mm rectangular		
Para modelos:	SYNTHESIS 08/50, SYNTHESIS 10/75, SYNTHESIS08-50V		



1

código	693375	referencia	CRIS0025
descripción	vidrio L 525mm An 93mm espesor 6mm rectangular		
Para modelos:	T2 POLIS MC16, T2 POLIS MC26, T4 POLIS MC16, T4 POLIS MC26		



1

código	693376	referencia	CRIS0028
descripción	vidrio L 725mm An 93mm espesor 6mm rectangular		
Para modelos:	T3 POLIS MC16, T3 POLIS MC26, T6 POLIS MC16, T6 POLIS MC26		

losas de chamota



1

código	850022	referencia	N/A REFR0001
descripción	placa inferior L 495mm An 495mm H 16mm horno de pizza para ELP500		

ruedas dentadas



1

código	693392	referencia	MECC0035
descripción	rueda dentada dientes 10 soporte de eje ø 20mm ø 44mm ø cubomm acero inoxidable		
Para modelos:	SYNTHESIS 08/50, SYNTHESIS 08/50 A, SYNTHESIS 10/75, SYNTHESIS 10/75 A, SYNTHESIS 10/75 B22, SYNTHESIS08-50V		

pomos

pomos universales



1

código	110253	referencia	MANI0021 MANI0025
descripción	pomo interruptor marca cero T máx°C°C ø 50mm eje ø 6x4,6mm parte plana arriba negro		
Para modelos:	SYNTHESIS 08/50, SYNTHESIS 10/75, SYNTHESIS08-50V		

pomos personalizados para fabricantes

ZANOLLI



1

código	111748	referencia	MANI0022
descripción	pomo potenciómetro ø 46mm eje ø 6.5mm plata		
Para modelos:	SYNTHESIS 05/40 A, SYNTHESIS 08/50, SYNTHESIS 10/75, SYNTHESIS08-50V		

manillas y volantes

manillas en forma de estrella



1

código	111128	referencia	MANI0020
descripción	manilla en forma de estrella eje 5x5mm ø 60mm		

bisagras

soporte de puerta



1

código	693384	referencia	SUPP0139 SUPP0207 SUPP0391
descripción	cojinete giratorio pos. de montaje derecho con perno		
Para modelos:	CITIZEN 6, CITIZEN 9, T2 POLIS MC16, T3 POLIS MC16, T4 POLIS MC16, T6 POLIS MC16		

1

código	693385	referencia	SUPP0140 SUPP0206 SUPP0392
descripción	cojinete giratorio pos. de montaje izquierdo con perno		
Para modelos:	CITIZEN 6, CITIZEN 9, T2 POLIS MC16, T3 POLIS MC16, T4 POLIS MC16, T6 POLIS MC16		

juntas

juntas térmicas

juntas para puertas

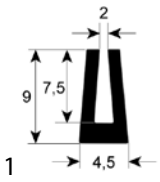

1

código	900456	referencia	GUAR0010
descripción	junta de puerta perfil 2934 UE al metro		
Para modelos:	CITIZEN 6, CITIZEN 9, T2 POLIS MC16, T2 POLIS MC26, T3 POLIS MC16, T3 POLIS MC26, T4 POLIS MC16, T4 POLIS MC26, T6 POLIS MC16, T6 POLIS MC26		

técnica de accionamiento y rodamientos de bolas

rodamientos de bolas

cajinets brida



1

código	693388	referencia	CUSC0022
descripción	coinete de brida árbol ø 12mm An 38mm brida 2 orificios dist. del agujero 48mm H 15mm		
Para modelos:	SYNTHESIS 05/40 A, SYNTHESIS 08/50, SYNTHESIS 08/50 A, SYNTHESIS 10/75, SYNTHESIS 10/75 A, SYNTHESIS 10/75 B22, SYNTHESIS08-50V		

muelles

muelles de torsión



1

código	693386	referencia	SPRI0010
descripción	resorte de torsión ø 27.4mm L2 148mm espesor de hilo 3.4mm pos. de montaje derecho L1 9mm		
Para modelos:	T2 POLIS MC16, T2 POLIS MC26, T3 POLIS MC16, T3 POLIS MC26, T4 POLIS MC16, T4 POLIS MC26, T6 POLIS MC16, T6 POLIS MC26		



1

código	693387	referencia	SPRI0009
descripción	resorte de torsión ø 27.4mm L2 150mm espesor de hilo 3.6mm pos. de montaje izquierdo L1 10mm		
Para modelos:	CITIZEN 6, CITIZEN 9, T2 POLIS MC16, T2 POLIS MC26, T3 POLIS MC16, T3 POLIS MC26, T4 POLIS MC16, T4 POLIS MC26, T6 POLIS MC16, T6 POLIS MC26		

consumibles

fusibles

fusibles finos

portafusibles



1

código	550691	referencia	ELET0058
descripción	portafusibles		
Para modelos:	CITIZEN 6, CITIZEN 9, SYNTHESIS 08/50, SYNTHESIS 10/75, SYNTHESIS08-50V		

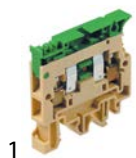

1

código	550848	referencia	ELET0440
descripción	portafusibles fusible adaptable ø5x20mm		